

Schets	Artikelnummer	Omschrijving	Afmeting	Lengte	Kleur	Bruto verkoopprijs / st.
--------	---------------	--------------	----------	--------	-------	--------------------------



Prijslijst 1-6-2025

Prinz PS 400 System



- > Screwing section system with aluminium upper and base profile.
- > For covering thicknesses from 7 - 17,5 mm.
- > Continuously variable adaptation of both height and inclination.
- > Optimal frictional connection by using drilling screws DIN 7505P.
- > Base and upper section incl - fixing material are shrink-wrapped together.
- > Patent No. 1442687.

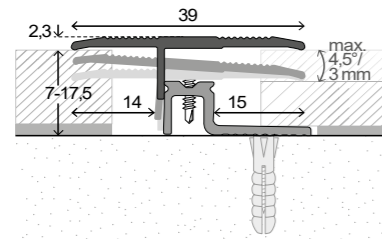

424 23 10 270	PS 400 Connection section - for covering thicknesses from 7 - 17,5 mm.	39 mm	270 cm	SB	gold	58,75
424 13 10 100	PS 400 Connection section - for covering thicknesses from 7 - 17,5 mm.	39 mm	100 cm	SB	gold	23,30
424 23 10 090	PS 400 Connection section - for covering thicknesses from 7 - 17,5 mm.	39 mm	90 cm	SB	gold	21,00
424 23 13 270	PS 400 Connection section - for covering thicknesses from 7 - 17,5 mm.	39 mm	270 cm	SB	sahara	58,75
424 13 13 100	PS 400 Connection section - for covering thicknesses from 7 - 17,5 mm.	39 mm	100 cm	SB	sahara	23,30
424 23 13 090	PS 400 Connection section - for covering thicknesses from 7 - 17,5 mm.	39 mm	90 cm	SB	sahara	21,00
424 23 11 270	PS 400 Connection section - for covering thicknesses from 7 - 17,5 mm.	39 mm	270 cm	SB	silver	58,75
424 13 11 100	PS 400 Connection section - for covering thicknesses from 7 - 17,5 mm.	39 mm	100 cm	SB	silver	23,30
424 23 11 090	PS 400 Connection section - for covering thicknesses from 7 - 17,5 mm.	39 mm	90 cm	SB	silver	21,00
424 23 14 270	PS 400 Connection section - for covering thicknesses from 7 - 17,5 mm.	39 mm	270 cm	SB	stainless steel matt	62,40
424 13 14 100	PS 400 Connection section - for covering thicknesses from 7 - 17,5 mm.	39 mm	100 cm	SB	stainless steel matt	24,55
424 23 14 090	PS 400 Connection section - for covering thicknesses from 7 - 17,5 mm.	39 mm	90 cm	SB	stainless steel matt	22,45
424 23 09 270	PS 400 Connection section - for covering thicknesses from 7 - 17,5 mm.	39 mm	270 cm	SB	stainless steel polished	69,95
424 13 09 100	PS 400 Connection section - for covering thicknesses from 7 - 17,5 mm.	39 mm	100 cm	SB	stainless steel polished	26,35
424 23 09 090	PS 400 Connection section - for covering thicknesses from 7 - 17,5 mm.	39 mm	90 cm	SB	stainless steel polished	24,30

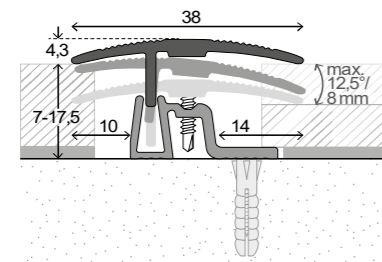

401 23 10 270	PS 400 Connection section - for covering thicknesses from 7 - 17,5 mm.	38 mm	270 cm	SB	gold	58,75
401 13 10 100	PS 400 Connection section - for covering thicknesses from 7 - 17,5 mm.	38 mm	100 cm	SB	gold	23,30
401 23 10 090	PS 400 Connection section - for covering thicknesses from 7 - 17,5 mm.	38 mm	90 cm	SB	gold	21,00
401 23 13 270	PS 400 Connection section - for covering thicknesses from 7 - 17,5 mm.	38 mm	270 cm	SB	sahara	58,75
401 13 13 100	PS 400 Connection section - for covering thicknesses from 7 - 17,5 mm.	38 mm	100 cm	SB	sahara	23,30
401 23 13 090	PS 400 Connection section - for covering thicknesses from 7 - 17,5 mm.	38 mm	90 cm	SB	sahara	21,00
401 23 11 270	PS 400 Connection section - for covering thicknesses from 7 - 17,5 mm.	38 mm	270 cm	SB	silver	58,75
401 13 11 100	PS 400 Connection section - for covering thicknesses from 7 - 17,5 mm.	38 mm	100 cm	SB	silver	23,30
401 23 11 090	PS 400 Connection section - for covering thicknesses from 7 - 17,5 mm.	38 mm	90 cm	SB	silver	21,00
401 23 14 270	PS 400 Connection section - for covering thicknesses from 7 - 17,5 mm.	38 mm	270 cm	SB	stainless steel matt	62,40
401 13 14 100	PS 400 Connection section - for covering thicknesses from 7 - 17,5 mm.	38 mm	100 cm	SB	stainless steel matt	24,55
401 23 14 090	PS 400 Connection section - for covering thicknesses from 7 - 17,5 mm.	38 mm	90 cm	SB	stainless steel matt	22,45
401 23 09 270	PS 400 Connection section - for covering thicknesses from 7 - 17,5 mm.	38 mm	270 cm	SB	stainless steel polished	69,95
401 13 09 100	PS 400 Connection section - for covering thicknesses from 7 - 17,5 mm.	38 mm	100 cm	SB	stainless steel polished	26,35
401 23 09 090	PS 400 Connection section - for covering thicknesses from 7 - 17,5 mm.	38 mm	90 cm	SB	stainless steel polished	24,30
401 23 17 270	PS 400 Connection section - for covering thicknesses from 7 - 17,5 mm.	38 mm	270 cm	SB	black anodised	69,95
401 13 17 100	PS 400 Connection section - for covering thicknesses from 7 - 17,5 mm.	38 mm	100 cm	SB	black anodised	26,35
401 23 17 090	PS 400 Connection section - for covering thicknesses from 7 - 17,5 mm.	38 mm	90 cm	SB	black anodised	24,30

Schets	Artikelnummer	Omschrijving	Afmeting	Lengte	Kleur	Bruto verkoopprijs / st.
	408 23 13 270	PS 400 Connection section - for covering thicknesses from 7 - 17,5 mm - with expanded	38 mm	270 cm SB	sahara	70,10
	408 13 13 100	PS 400 Connection section - for covering thicknesses from 7 - 17,5 mm - with expanded	38 mm	100 cm SB	sahara	27,70
	408 23 11 270	PS 400 Connection section - for covering thicknesses from 7 - 17,5 mm - with expanded	38 mm	270 cm SB	silver	70,10
	408 13 11 100	PS 400 Connection section - for covering thicknesses from 7 - 17,5 mm - with expanded	38 mm	100 cm SB	silver	27,70
	408 23 14 270	PS 400 Connection section - for covering thicknesses from 7 - 17,5 mm - with expanded	38 mm	270 cm SB	stainless steel matt	73,85
	408 13 14 100	PS 400 Connection section - for covering thicknesses from 7 - 17,5 mm - with expanded	38 mm	100 cm SB	stainless steel matt	28,80
	408 23 09 270	PS 400 Connection section - for covering thicknesses from 7 - 17,5 mm - with expanded	38 mm	270 cm SB	stainless steel polished	80,10
	408 13 09 100	PS 400 Connection section - for covering thicknesses from 7 - 17,5 mm - with expanded	38 mm	100 cm SB	stainless steel polished	30,35
	400 23 11 270	PS 400 Connection section - for covering thicknesses from 7 - 17,5 mm.	43 mm	270 cm SB	silver	62,00
	400 13 11 100	PS 400 Connection section - for covering thicknesses from 7 - 17,5 mm.	43 mm	100 cm SB	silver	24,35
	400 23 11 090	PS 400 Connection section - for covering thicknesses from 7 - 17,5 mm.	43 mm	90 cm SB	silver	22,30
	400 23 14 270	PS 400 Connection section - for covering thicknesses from 7 - 17,5 mm.	43 mm	270 cm SB	stainless steel matt	65,65
	400 13 14 100	PS 400 Connection section - for covering thicknesses from 7 - 17,5 mm.	43 mm	100 cm SB	stainless steel matt	25,60
	400 23 14 090	PS 400 Connection section - for covering thicknesses from 7 - 17,5 mm.	43 mm	90 cm SB	stainless steel matt	23,65
	402 23 10 270	PS 400 Adaptation section - for covering thicknesses from 7 - 17,5 mm.	50 mm	270 cm SB	gold	66,85
	402 13 10 100	PS 400 Adaptation section - for covering thicknesses from 7 - 17,5 mm.	50 mm	100 cm SB	gold	25,65
	402 23 10 090	PS 400 Adaptation section - for covering thicknesses from 7 - 17,5 mm.	50 mm	90 cm SB	gold	23,20
	402 23 13 270	PS 400 Adaptation section - for covering thicknesses from 7 - 17,5 mm.	50 mm	270 cm SB	sahara	66,85
	402 13 13 100	PS 400 Adaptation section - for covering thicknesses from 7 - 17,5 mm.	50 mm	100 cm SB	sahara	25,65
	402 23 13 090	PS 400 Adaptation section - for covering thicknesses from 7 - 17,5 mm.	50 mm	90 cm SB	sahara	23,20
	402 23 11 270	PS 400 Adaptation section - for covering thicknesses from 7 - 17,5 mm.	50 mm	270 cm SB	silver	66,85
	402 13 11 100	PS 400 Adaptation section - for covering thicknesses from 7 - 17,5 mm.	50 mm	100 cm SB	silver	25,65
	402 23 11 090	PS 400 Adaptation section - for covering thicknesses from 7 - 17,5 mm.	50 mm	90 cm SB	silver	23,20
	402 23 14 270	PS 400 Adaptation section - for covering thicknesses from 7 - 17,5 mm.	50 mm	270 cm SB	stainless steel matt	70,90
	402 13 14 100	PS 400 Adaptation section - for covering thicknesses from 7 - 17,5 mm.	50 mm	100 cm SB	stainless steel matt	26,95
	402 23 14 090	PS 400 Adaptation section - for covering thicknesses from 7 - 17,5 mm.	50 mm	90 cm SB	stainless steel matt	24,80
	402 23 09 270	PS 400 Adaptation section - for covering thicknesses from 7 - 17,5 mm.	50 mm	270 cm SB	stainless steel polished	78,60
	402 13 09 100	PS 400 Adaptation section - for covering thicknesses from 7 - 17,5 mm.	50 mm	100 cm SB	stainless steel polished	29,90
	402 23 09 090	PS 400 Adaptation section - for covering thicknesses from 7 - 17,5 mm.	50 mm	90 cm SB	stainless steel polished	27,35
	402 23 17 270	PS 400 Adaptation section - for covering thicknesses from 7 - 17,5 mm.	50 mm	270 cm SB	black anodised	78,60
402 13 17 100	PS 400 Adaptation section - for covering thicknesses from 7 - 17,5 mm.	50 mm	100 cm SB	black anodised	29,90	
402 23 17 090	PS 400 Adaptation section - for covering thicknesses from 7 - 17,5 mm.	50 mm	90 cm SB	black anodised	27,35	
	404 23 10 270	PS 400 Edge section - for covering thicknesses from 7 - 17,5 mm.	28 mm	270 cm SB	gold	56,70
	404 13 10 100	PS 400 Edge section - for covering thicknesses from 7 - 17,5 mm.	28 mm	100 cm SB	gold	22,45
	404 23 10 090	PS 400 Edge section - for covering thicknesses from 7 - 17,5 mm.	28 mm	90 cm SB	gold	20,55
	404 23 13 270	PS 400 Edge section - for covering thicknesses from 7 - 17,5 mm.	28 mm	270 cm SB	sahara	56,70
	404 13 13 100	PS 400 Edge section - for covering thicknesses from 7 - 17,5 mm.	28 mm	100 cm SB	sahara	22,45
	404 23 13 090	PS 400 Edge section - for covering thicknesses from 7 - 17,5 mm.	28 mm	90 cm SB	sahara	20,55
	404 23 11 270	PS 400 Edge section - for covering thicknesses from 7 - 17,5 mm.	28 mm	270 cm SB	silver	56,70
	404 13 11 100	PS 400 Edge section - for covering thicknesses from 7 - 17,5 mm.	28 mm	100 cm SB	silver	22,45
	404 23 11 090	PS 400 Edge section - for covering thicknesses from 7 - 17,5 mm.	28 mm	90 cm SB	silver	20,55
	404 23 14 270	PS 400 Edge section - for covering thicknesses from 7 - 17,5 mm.	28 mm	270 cm SB	stainless steel matt	60,10
	404 13 14 100	PS 400 Edge section - for covering thicknesses from 7 - 17,5 mm.	28 mm	100 cm SB	stainless steel matt	23,60
	404 23 14 090	PS 400 Edge section - for covering thicknesses from 7 - 17,5 mm.	28 mm	90 cm SB	stainless steel matt	21,85
	404 23 09 270	PS 400 Edge section - for covering thicknesses from 7 - 17,5 mm.	28 mm	270 cm SB	stainless steel polished	67,65
	404 13 09 100	PS 400 Edge section - for covering thicknesses from 7 - 17,5 mm.	28 mm	100 cm SB	stainless steel polished	25,75
	404 23 09 090	PS 400 Edge section - for covering thicknesses from 7 - 17,5 mm.	28 mm	90 cm SB	stainless steel polished	23,70
	404 23 17 270	PS 400 Edge section - for covering thicknesses from 7 - 17,5 mm.	28 mm	270 cm SB	black anodised	67,65
404 13 17 100	PS 400 Edge section - for covering thicknesses from 7 - 17,5 mm.	28 mm	100 cm SB	black anodised	25,75	

Schets	Artikelnummer	Omschrijving	Afmeting	Lengte	Kleur	Bruto verkoopprijs / st.
	404 23 17 090	PS 400 Edge section - for covering thicknesses from 7 - 17,5 mm	28 mm	90 cm SB	black anodised	23,70
	407 23 13 270	PS 400 Edge section - for covering thicknesses from 7 - 17,5 mm - with expanded base	28 mm	270 cm SB	sahara	65,75
	407 13 13 100	PS 400 Edge section - for covering thicknesses from 7 - 17,5 mm - with expanded base	28 mm	100 cm SB	sahara	25,25
	407 23 11 270	PS 400 Edge section - for covering thicknesses from 7 - 17,5 mm - with expanded base	28 mm	270 cm SB	silver	65,75
	407 13 11 100	PS 400 Edge section - for covering thicknesses from 7 - 17,5 mm - with expanded base	28 mm	100 cm SB	silver	25,25
	407 23 14 270	PS 400 Edge section - for covering thicknesses from 7 - 17,5 mm - with expanded base	28 mm	270 cm SB	stainless steel matt	68,60
	407 13 14 100	PS 400 Edge section - for covering thicknesses from 7 - 17,5 mm - with expanded base	28 mm	100 cm SB	stainless steel matt	26,20
	407 23 09 270	PS 400 Edge section - for covering thicknesses from 7 - 17,5 mm - with expanded base	28 mm	270 cm SB	stainless steel polished	74,25
	407 13 09 100	PS 400 Edge section - for covering thicknesses from 7 - 17,5 mm - with expanded base	28 mm	100 cm SB	stainless steel polished	28,25

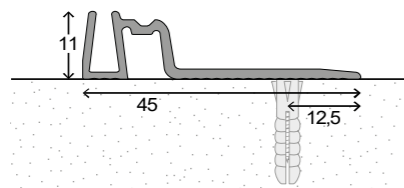

	408 23 06 270	PS 400 Base section with long base - for covering thicknesses 7 - 17,5 mm	45 x 11 mm	270 cm 0	aluminium natural	29,85
--	---------------	---	------------	----------	-------------------	-------

Prinz PS 400 XXL System

**PS
400
XXL**

- > Screwing section system with aluminium upper and base profile.
- > For covering thicknesses from 17 - 27 mm.
- > Continuously variable adaptation of both height and inclination.
- > Optimal frictional connection by using drilling screws DIN 7505P.
- > Base and upper section incl - fixing material are shrink-wrapped together.
- > Patent No. 1442687.

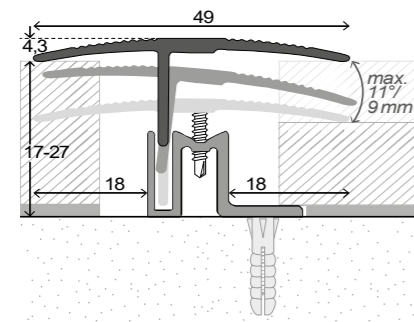

410 23 13 270	PS 400 XXL Connection section - for covering thicknesses from 17 - 27 mm.	49 mm	270 cm SB	sahara	79,80
410 23 13 090	PS 400 XXL Connection section - for covering thicknesses from 17 - 27 mm.	49 mm	90 cm SB	sahara	28,45
410 23 11 270	PS 400 XXL Connection section - for covering thicknesses from 17 - 27 mm.	49 mm	270 cm SB	silver	79,80
410 23 11 090	PS 400 XXL Connection section - for covering thicknesses from 17 - 27 mm.	49 mm	90 cm SB	silver	28,45
410 23 14 270	PS 400 XXL Connection section - for covering thicknesses from 17 - 27 mm.	49 mm	270 cm SB	stainless steel matt	83,60
410 23 14 090	PS 400 XXL Connection section - for covering thicknesses from 17 - 27 mm.	49 mm	90 cm SB	stainless steel matt	29,70

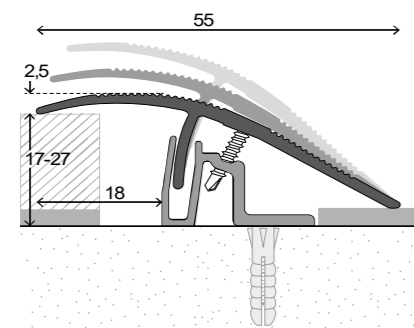

411 23 13 270	PS 400 XXL Adaptation section - for covering thicknesses from 17 - 27 mm.	55 mm	270 cm SB	sahara	84,25
411 23 13 090	PS 400 XXL Adaptation section - for covering thicknesses from 17 - 27 mm.	55 mm	90 cm SB	sahara	29,75
411 23 11 270	PS 400 XXL Adaptation section - for covering thicknesses from 17 - 27 mm.	55 mm	270 cm SB	silver	84,25
411 23 11 090	PS 400 XXL Adaptation section - for covering thicknesses from 17 - 27 mm.	55 mm	90 cm SB	silver	29,75
411 23 14 270	PS 400 XXL Adaptation section - for covering thicknesses from 17 - 27 mm.	55 mm	270 cm SB	stainless steel matt	88,20
411 23 14 090	PS 400 XXL Adaptation section - for covering thicknesses from 17 - 27 mm.	55 mm	90 cm SB	stainless steel matt	30,70

Prinz PS 400 PEP System

DC

- > Screwing section system with aluminium upper and base profile.
- > For covering thicknesses from 6 - 13 mm, with elevation blocks up to 18 mm.



Schets	Artikelnummer	Omschrijving	Afmeting	Lengte	Kleur	Bruto verkoopprijs / st.
--------	---------------	--------------	----------	--------	-------	--------------------------

PS 400 PEP

- > Continuously variable adaptation of both height and inclination.
- > Elevation blocks for covering thicknesses from 13 - 18 mm are availabled separately.
- > Optimal frictional connection by using drilling screws DIN 7505P.
- > Base and upper section incl - fixing material are shrink-wrapped together.
- > Patent No. 2374962

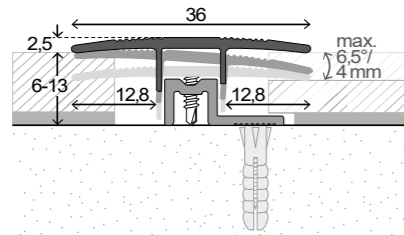

415 23 10 270	PS 400 Connection section PEP - for covering thicknesses from 6 - 13 mm.	36 mm	270 cm	SB	gold	47,40
415 13 10 100	PS 400 Connection section PEP - for covering thicknesses from 6 - 13 mm.	36 mm	100 cm	SB	gold	18,80
415 23 10 090	PS 400 Connection section PEP - for covering thicknesses from 6 - 13 mm.	36 mm	90 cm	SB	gold	17,10
415 23 13 270	PS 400 Connection section PEP - for covering thicknesses from 6 - 13 mm.	36 mm	270 cm	SB	sahara	47,40
415 13 13 100	PS 400 Connection section PEP - for covering thicknesses from 6 - 13 mm.	36 mm	100 cm	SB	sahara	18,80
415 23 13 090	PS 400 Connection section PEP - for covering thicknesses from 6 - 13 mm.	36 mm	90 cm	SB	sahara	17,10
415 23 11 270	PS 400 Connection section PEP - for covering thicknesses from 6 - 13 mm.	36 mm	270 cm	SB	silver	47,40
415 13 11 100	PS 400 Connection section PEP - for covering thicknesses from 6 - 13 mm.	36 mm	100 cm	SB	silver	18,80
415 23 11 090	PS 400 Connection section PEP - for covering thicknesses from 6 - 13 mm.	36 mm	90 cm	SB	silver	17,10
415 23 14 270	PS 400 Connection section PEP - for covering thicknesses from 6 - 13 mm.	36 mm	270 cm	SB	stainless steel matt	50,50
415 13 14 100	PS 400 Connection section PEP - for covering thicknesses from 6 - 13 mm.	36 mm	100 cm	SB	stainless steel matt	19,90
415 23 14 090	PS 400 Connection section PEP - for covering thicknesses from 6 - 13 mm.	36 mm	90 cm	SB	stainless steel matt	18,00
415 13 09 100	PS 400 Connection section PEP - for covering thicknesses from 6 - 13 mm.	36 mm	100 cm	SB	stainless steel polished	21,80

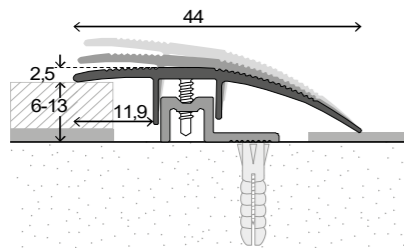

416 23 13 270	PS 400 Adaptation section PEP - for covering thicknesses from 6 - 13 mm.	44 mm	270 cm	SB	sahara	52,95
416 13 13 100	PS 400 Adaptation section PEP - for covering thicknesses from 6 - 13 mm.	44 mm	100 cm	SB	sahara	20,80
416 23 13 090	PS 400 Adaptation section PEP - for covering thicknesses from 6 - 13 mm.	44 mm	90 cm	SB	sahara	18,95
416 23 11 270	PS 400 Adaptation section PEP - for covering thicknesses from 6 - 13 mm.	44 mm	270 cm	SB	silver	52,95
416 13 11 100	PS 400 Adaptation section PEP - for covering thicknesses from 6 - 13 mm.	44 mm	100 cm	SB	silver	20,80
416 23 11 090	PS 400 Adaptation section PEP - for covering thicknesses from 6 - 13 mm.	44 mm	90 cm	SB	silver	18,95
416 23 14 270	PS 400 Adaptation section PEP - for covering thicknesses from 6 - 13 mm.	44 mm	270 cm	SB	stainless steel matt	56,60
416 13 14 100	PS 400 Adaptation section PEP - for covering thicknesses from 6 - 13 mm.	44 mm	100 cm	SB	stainless steel matt	22,10
416 23 14 090	PS 400 Adaptation section PEP - for covering thicknesses from 6 - 13 mm.	44 mm	90 cm	SB	stainless steel matt	20,25

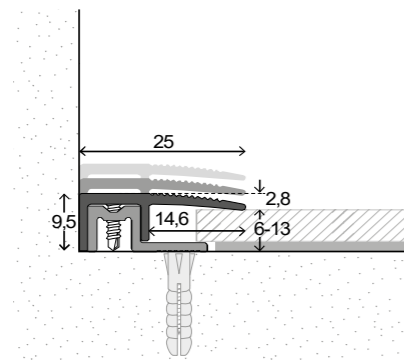

417 23 13 270	PS 400 Edge section PEP - for covering thicknesses from 6 - 13 mm.	25 mm	270 cm	SB	sahara	45,10
417 13 13 100	PS 400 Edge section PEP - for covering thicknesses from 6 - 13 mm.	25 mm	100 cm	SB	sahara	17,90
417 23 13 090	PS 400 Edge section PEP - for covering thicknesses from 6 - 13 mm.	25 mm	90 cm	SB	sahara	16,25
417 23 11 270	PS 400 Edge section PEP - for covering thicknesses from 6 - 13 mm.	25 mm	270 cm	SB	silver	45,10
417 13 11 100	PS 400 Edge section PEP - for covering thicknesses from 6 - 13 mm.	25 mm	100 cm	SB	silver	17,90
417 23 11 090	PS 400 Edge section PEP - for covering thicknesses from 6 - 13 mm.	25 mm	90 cm	SB	silver	16,25
417 23 14 270	PS 400 Edge section PEP - for covering thicknesses from 6 - 13 mm.	25 mm	270 cm	SB	stainless steel matt	48,10
417 13 14 100	PS 400 Edge section PEP - for covering thicknesses from 6 - 13 mm.	25 mm	100 cm	SB	stainless steel matt	18,85
417 23 14 090	PS 400 Edge section PEP - for covering thicknesses from 6 - 13 mm.	25 mm	90 cm	SB	stainless steel matt	17,15

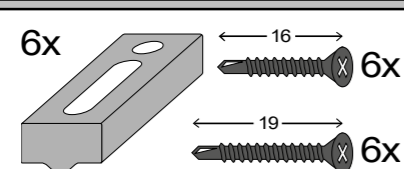

415 02 10 000	PS 400 PEP- Elevation block set - plastic - for covering thicknesses up to 18 mm.	set á 6 pcs.			gold	5,40
415 02 13 000	PS 400 PEP- Elevation block set - plastic - for covering thicknesses up to 18 mm.	set á 6 pcs.			sahara, stainless steel matt	5,40
415 02 11 000	PS 400 PEP- Elevation block set - plastic - for covering thicknesses up to 18 mm.	set á 6 pcs.			silver, stainless steel poliert	5,40

Per profile 90/100 cm: 1 set is needed, per profile 270 cm: 3 sets.

Prinz PS 400 Cable Ducts

PS

- > Screwing section system with aluminium upper and base profile.
- > For covering thicknesses from 7 - 18 mm.
- > For a concealed laying of cables in parquet / laminate floorings.



Schets	Artikelnummer	Omschrijving	Afmeting	Lengte	Kleur	Bruto verkoopprijs / st.
--------	---------------	--------------	----------	--------	-------	--------------------------

400

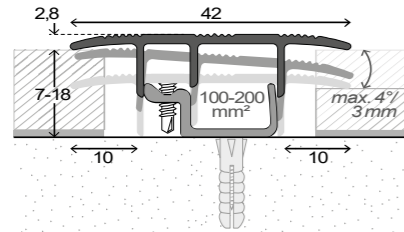

- > Continuously variable adaptation of both height and inclination.
- > Optimal frictional connection by using drilling screws DIN 7505P.
- > Base and upper section incl - fixing material are shrink-wrapped together.
- > Patent No. 1442687.



432 23 11 270	PS 400 Cable duct TYPE 1 - for covering thicknesses from 7 - 18 mm.	42 mm	270 cm SB	silver	68,05
432 23 11 090	PS 400 Cable duct TYPE 1 - for covering thicknesses from 7 - 18 mm.	42 mm	90 cm SB	silver	23,70
432 23 14 270	PS 400 Cable duct TYPE 1 - for covering thicknesses from 7 - 18 mm.	42 mm	270 cm SB	stainless steel matt	73,20
432 23 14 090	PS 400 Cable duct TYPE 1 - for covering thicknesses from 7 - 18 mm.	42 mm	90 cm SB	stainless steel matt	25,35
432 23 09 090	PS 400 Cable duct TYPE 1 - for covering thicknesses from 7 - 18 mm.	42 mm	90 cm SB	stainless steel polished	27,30

minimal cross section: 100 mm²
 maximal cross section: 200 mm²

For the compensation of differences in level up to 3 mm.

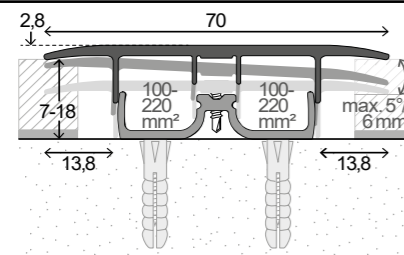

430 23 11 270	PS 400 Cable duct TYPE 2 - for covering thicknesses from 7 - 18 mm.	70 mm	270 cm SB	silver	98,05
430 23 14 270	PS 400 Cable duct TYPE 2 - for covering thicknesses from 7 - 18 mm.	70 mm	270 cm SB	stainless steel matt	106,95

minimal cross section: 200 mm²
 maximal cross section: 440 mm²

For the compensation of differences in level up to 6 mm.

Prinz PS 400 Stair Nosings

PS 400

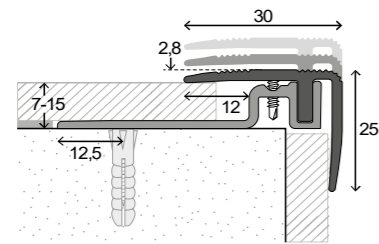

- > Screwing section system with aluminium upper and base profile.
- > For floor coverings 7 - 18 mm.
- > High load-bearing capacity and safety.
- > Optimal frictional connection by using drilling screws.
- > Base and upper section incl - fixing material are shrink-wrapped together.
- > Patent No. 1442687.



420 13 13 250	PS 400 Stair nosing - for covering thicknesses from 7 - 15 mm.	30 x 25 mm	250 cm SB	sahara	79,40
420 13 13 100	PS 400 Stair nosing - for covering thicknesses from 7 - 15 mm.	30 x 25 mm	100 cm SB	sahara	32,00
420 13 11 250	PS 400 Stair nosing - for covering thicknesses from 7 - 15 mm.	30 x 25 mm	250 cm SB	silver	79,40
420 13 11 100	PS 400 Stair nosing - for covering thicknesses from 7 - 15 mm.	30 x 25 mm	100 cm SB	silver	32,00
420 13 14 250	PS 400 Stair nosing - for covering thicknesses from 7 - 15 mm.	30 x 25 mm	250 cm SB	stainless steel matt	83,25
420 13 14 100	PS 400 Stair nosing - for covering thicknesses from 7 - 15 mm.	30 x 25 mm	100 cm SB	stainless steel matt	33,55
420 13 09 250	PS 400 Stair nosing - for covering thicknesses from 7 - 15 mm.	30 x 25 mm	250 cm SB	stainless steel polished	94,00
420 13 09 100	PS 400 Stair nosing - for covering thicknesses from 7 - 15 mm.	30 x 25 mm	100 cm SB	stainless steel polished	38,15

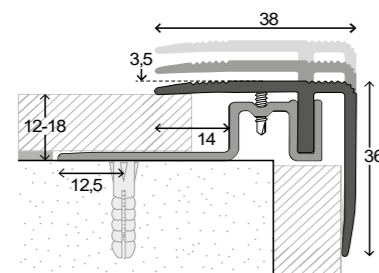

422 13 13 250	PS 400 Stair nosing - for covering thicknesses from 12 - 18 mm.	38 x 36 mm	250 cm SB	sahara	94,00
422 13 13 100	PS 400 Stair nosing - for covering thicknesses from 12 - 18 mm.	38 x 36 mm	100 cm SB	sahara	36,95
422 13 11 250	PS 400 Stair nosing - for covering thicknesses from 12 - 18 mm.	38 x 36 mm	250 cm SB	silver	94,00
422 13 11 100	PS 400 Stair nosing - for covering thicknesses from 12 - 18 mm.	38 x 36 mm	100 cm SB	silver	36,95
422 13 14 250	PS 400 Stair nosing - for covering thicknesses from 12 - 18 mm.	38 x 36 mm	250 cm SB	stainless steel matt	100,50
422 13 14 100	PS 400 Stair nosing - for covering thicknesses from 12 - 18 mm.	38 x 36 mm	100 cm SB	stainless steel matt	39,35

Prinz LPS 220 System

LPS 220

- > Screw profile system with aluminium base section and aluminium cover section.
- > Suitable for coating thicknesses of 7 - 16 mm.
- > Fits automatically to various laminate and parquet heights.
- > Base section and cover section incl - fixing material shrink-wrapped together.



Schets	Artikelnummer	Omschrijving	Afmeting	Lengte	Kleur	Bruto verkoopprijs / st.
--------	---------------	--------------	----------	--------	-------	--------------------------

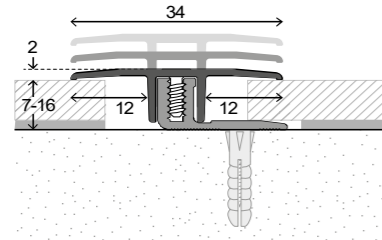

226 23 13 270	LPS 220 Connection section - for covering thicknesses 7 - 16 mm.	34 mm	270 cm SB	sahara	47,80
226 13 13 100	LPS 220 Connection section - for covering thicknesses 7 - 16 mm.	34 mm	100 cm SB	sahara	18,75
226 23 13 090	LPS 220 Connection section - for covering thicknesses 7 - 16 mm.	34 mm	90 cm SB	sahara	16,80
226 23 11 270	LPS 220 Connection section - for covering thicknesses 7 - 16 mm.	34 mm	270 cm SB	silver	46,45
226 13 11 100	LPS 220 Connection section - for covering thicknesses 7 - 16 mm.	34 mm	100 cm SB	silver	18,20
226 23 11 090	LPS 220 Connection section - for covering thicknesses 7 - 16 mm.	34 mm	90 cm SB	silver	16,30
226 23 14 270	LPS 220 Connection section - for covering thicknesses 7 - 16 mm.	34 mm	270 cm SB	stainless steel matt	49,45
226 13 14 100	LPS 220 Connection section - for covering thicknesses 7 - 16 mm.	34 mm	100 cm SB	stainless steel matt	19,30
226 23 14 090	LPS 220 Connection section - for covering thicknesses 7 - 16 mm.	34 mm	90 cm SB	stainless steel matt	17,35
226 23 19 270	LPS 220 Connection section - for covering thicknesses 7 - 16 mm.	34 mm	270 cm SB	stainless steel brushed	57,25
226 13 19 100	LPS 220 Connection section - for covering thicknesses 7 - 16 mm.	34 mm	100 cm SB	stainless steel brushed	22,05
226 23 19 090	LPS 220 Connection section - for covering thicknesses 7 - 16 mm.	34 mm	90 cm SB	stainless steel brushed	20,10

New design: plain surface without grooves.

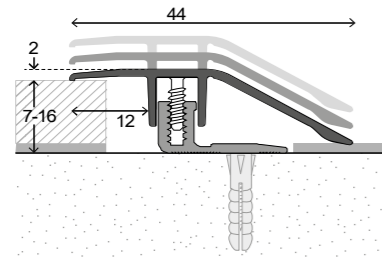

227 23 13 270	LPS 220 Adaptation section - for covering thicknesses 7 - 16 mm.	44 mm	270 cm SB	sahara	54,45
227 13 13 100	LPS 220 Adaptation section - for covering thicknesses 7 - 16 mm.	44 mm	100 cm SB	sahara	21,45
227 23 13 090	LPS 220 Adaptation section - for covering thicknesses 7 - 16 mm.	44 mm	90 cm SB	sahara	19,20
227 23 11 270	LPS 220 Adaptation section - for covering thicknesses 7 - 16 mm.	44 mm	270 cm SB	silver	52,95
227 13 11 100	LPS 220 Adaptation section - for covering thicknesses 7 - 16 mm.	44 mm	100 cm SB	silver	20,85
227 23 11 090	LPS 220 Adaptation section - for covering thicknesses 7 - 16 mm.	44 mm	90 cm SB	silver	18,65
227 23 14 270	LPS 220 Adaptation section - for covering thicknesses 7 - 16 mm.	44 mm	270 cm SB	stainless steel matt	55,90
227 13 14 100	LPS 220 Adaptation section - for covering thicknesses 7 - 16 mm.	44 mm	100 cm SB	stainless steel matt	22,30
227 23 14 090	LPS 220 Adaptation section - for covering thicknesses 7 - 16 mm.	44 mm	90 cm SB	stainless steel matt	19,65
227 23 19 270	LPS 220 Adaptation section - for covering thicknesses 7 - 16 mm.	44 mm	270 cm SB	stainless steel brushed	67,00
227 13 19 100	LPS 220 Adaptation section - for covering thicknesses 7 - 16 mm.	44 mm	100 cm SB	stainless steel brushed	25,70
227 23 19 090	LPS 220 Adaptation section - for covering thicknesses 7 - 16 mm.	44 mm	90 cm SB	stainless steel brushed	23,50

New design: plain surface without grooves.

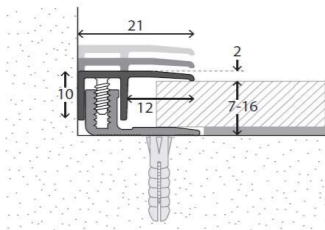

228 23 13 270	LPS 220 Edge section - for covering thicknesses 7 - 16 mm.	21 mm	270 cm SB	sahara	43,20
228 13 13 100	LPS 220 Edge section - for covering thicknesses 7 - 16 mm.	21 mm	100 cm SB	sahara	17,15
228 23 13 090	LPS 220 Edge section - for covering thicknesses 7 - 16 mm.	21 mm	90 cm SB	sahara	15,25
228 23 11 270	LPS 220 Edge section - for covering thicknesses 7 - 16 mm.	21 mm	270 cm SB	silver	42,00
228 13 11 100	LPS 220 Edge section - for covering thicknesses 7 - 16 mm.	21 mm	100 cm SB	silver	16,65
228 23 11 090	LPS 220 Edge section - for covering thicknesses 7 - 16 mm.	21 mm	90 cm SB	silver	14,80
228 23 14 270	LPS 220 Edge section - for covering thicknesses 7 - 16 mm.	21 mm	270 cm SB	stainless steel matt	44,55
228 13 14 100	LPS 220 Edge section - for covering thicknesses 7 - 16 mm.	21 mm	100 cm SB	stainless steel matt	17,50
228 23 14 090	LPS 220 Edge section - for covering thicknesses 7 - 16 mm.	21 mm	90 cm SB	stainless steel matt	15,70
228 23 19 270	LPS 220 Edge section - for covering thicknesses 7 - 16 mm.	21 mm	270 cm SB	stainless steel brushed	51,60
228 13 19 100	LPS 220 Edge section - for covering thicknesses 7 - 16 mm.	21 mm	100 cm SB	stainless steel brushed	19,80
228 23 19 090	LPS 220 Edge section - for covering thicknesses 7 - 16 mm.	21 mm	90 cm SB	stainless steel brushed	18,10

New design: plain surface without grooves.

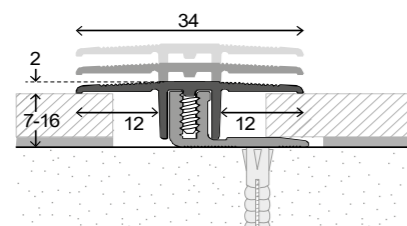

220 23 10 270	LPS 220 Connection section - for covering thicknesses 7 - 16 mm.	34 mm	270 cm SB	gold	45,10
220 13 10 100	LPS 220 Connection section - for covering thicknesses 7 - 16 mm.	34 mm	100 cm SB	gold	17,65
220 23 10 090	LPS 220 Connection section - for covering thicknesses 7 - 16 mm.	34 mm	90 cm SB	gold	15,85
220 23 13 270	LPS 220 Connection section - for covering thicknesses 7 - 16 mm.	34 mm	270 cm SB	sahara	45,10
220 13 13 100	LPS 220 Connection section - for covering thicknesses 7 - 16 mm.	34 mm	100 cm SB	sahara	17,65
220 23 13 090	LPS 220 Connection section - for covering thicknesses 7 - 16 mm.	34 mm	90 cm SB	sahara	15,85

Schets	Artikelnummer	Omschrijving	Afmeting	Lengte	Kleur	Bruto verkoopprijs / st.
	220 23 11 270	LPS 220 Connection section - for covering thicknesses 7 - 16 mm.	34 mm	270 cm SB	silver	43,75
	220 13 11 100	LPS 220 Connection section - for covering thicknesses 7 - 16 mm.	34 mm	100 cm SB	silver	17,15
	220 23 11 090	LPS 220 Connection section - for covering thicknesses 7 - 16 mm.	34 mm	90 cm SB	silver	15,40
	220 23 12 270	LPS 220 Connection section - for covering thicknesses 7 - 16 mm.	34 mm	270 cm SB	bronze	46,20
	220 13 12 100	LPS 220 Connection section - for covering thicknesses 7 - 16 mm.	34 mm	100 cm SB	bronze	18,20
	220 23 12 090	LPS 220 Connection section - for covering thicknesses 7 - 16 mm.	34 mm	90 cm SB	bronze	16,40
	220 23 14 270	LPS 220 Connection section - for covering thicknesses 7 - 16 mm.	34 mm	270 cm SB	stainless steel matt	46,20
	220 13 14 100	LPS 220 Connection section - for covering thicknesses 7 - 16 mm.	34 mm	100 cm SB	stainless steel matt	18,20
	220 23 14 090	LPS 220 Connection section - for covering thicknesses 7 - 16 mm.	34 mm	90 cm SB	stainless steel matt	16,40
	220 23 17 270	LPS 220 Connection section - for covering thicknesses 7 - 16 mm.	34 mm	270 cm SB	black anodised	49,70
220 13 17 100	LPS 220 Connection section - for covering thicknesses 7 - 16 mm.	34 mm	100 cm SB	black anodised	19,55	

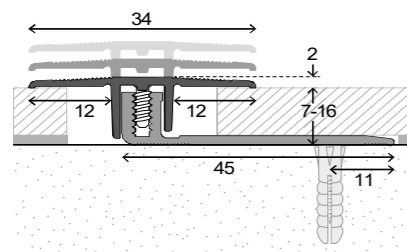

230 23 13 270	LPS 220 Connection section - for covering thicknesses 7 - 16 mm - incl. expanded base	34 mm	270 cm SB	sahara	54,45
230 13 13 100	LPS 220 Connection section - for covering thicknesses 7 - 16 mm - incl. expanded base	34 mm	100 cm SB	sahara	21,50
230 23 11 270	LPS 220 Connection section - for covering thicknesses 7 - 16 mm - incl. expanded base	34 mm	270 cm SB	silver	52,95
230 13 11 100	LPS 220 Connection section - for covering thicknesses 7 - 16 mm - incl. expanded base	34 mm	100 cm SB	silver	20,90
230 23 14 270	LPS 220 Connection section - for covering thicknesses 7 - 16 mm - incl. expanded base	34 mm	270 cm SB	stainless steel matt	56,45
230 13 14 100	LPS 220 Connection section - for covering thicknesses 7 - 16 mm - incl. expanded base	34 mm	100 cm SB	stainless steel matt	22,15

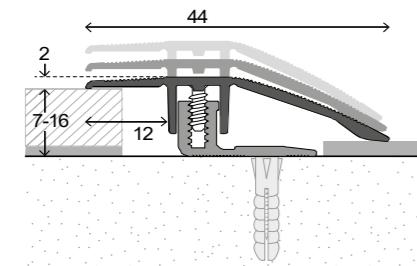

221 23 10 270	LPS 220 Adaptation section - for covering thicknesses 7 - 16 mm.	44 mm	270 cm SB	gold	51,30
221 13 10 100	LPS 220 Adaptation section - for covering thicknesses 7 - 16 mm.	44 mm	100 cm SB	gold	20,25
221 23 10 090	LPS 220 Adaptation section - for covering thicknesses 7 - 16 mm.	44 mm	90 cm SB	gold	18,10
221 23 13 270	LPS 220 Adaptation section - for covering thicknesses 7 - 16 mm.	44 mm	270 cm SB	sahara	51,30
221 13 13 100	LPS 220 Adaptation section - for covering thicknesses 7 - 16 mm.	44 mm	100 cm SB	sahara	20,25
221 23 13 090	LPS 220 Adaptation section - for covering thicknesses 7 - 16 mm.	44 mm	90 cm SB	sahara	18,10
221 23 11 270	LPS 220 Adaptation section - for covering thicknesses 7 - 16 mm.	44 mm	270 cm SB	silver	49,85
221 13 11 100	LPS 220 Adaptation section - for covering thicknesses 7 - 16 mm.	44 mm	100 cm SB	silver	19,65
221 23 11 090	LPS 220 Adaptation section - for covering thicknesses 7 - 16 mm.	44 mm	90 cm SB	silver	17,60
221 23 12 270	LPS 220 Adaptation section - for covering thicknesses 7 - 16 mm.	44 mm	270 cm SB	bronze	52,80
221 13 12 100	LPS 220 Adaptation section - for covering thicknesses 7 - 16 mm.	44 mm	100 cm SB	bronze	21,05
221 23 14 270	LPS 220 Adaptation section - for covering thicknesses 7 - 16 mm.	44 mm	270 cm SB	stainless steel matt	52,80
221 13 14 100	LPS 220 Adaptation section - for covering thicknesses 7 - 16 mm.	44 mm	100 cm SB	stainless steel matt	21,05
221 23 14 090	LPS 220 Adaptation section - for covering thicknesses 7 - 16 mm.	44 mm	90 cm SB	stainless steel matt	18,55
221 23 17 270	LPS 220 Adaptation section - for covering thicknesses 7 - 16 mm.	44 mm	270 cm SB	black anodised	56,30
221 13 17 100	LPS 220 Adaptation section - for covering thicknesses 7 - 16 mm.	44 mm	100 cm SB	black anodised	22,45

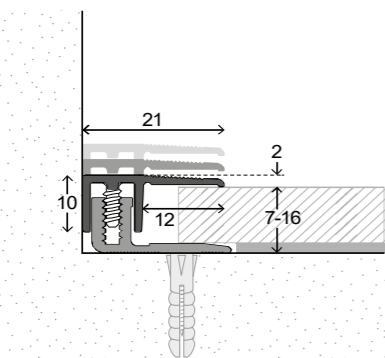

222 23 10 270	LPS 220 Edge section - for covering thicknesses 7 - 16 mm.	21 mm	270 cm SB	gold	40,65
222 13 10 100	LPS 220 Edge section - for covering thicknesses 7 - 16 mm.	21 mm	100 cm SB	gold	16,15
222 23 10 090	LPS 220 Edge section - for covering thicknesses 7 - 16 mm.	21 mm	90 cm SB	gold	14,45
222 23 13 270	LPS 220 Edge section - for covering thicknesses 7 - 16 mm.	21 mm	270 cm SB	sahara	40,65
222 13 13 100	LPS 220 Edge section - for covering thicknesses 7 - 16 mm.	21 mm	100 cm SB	sahara	16,15
222 23 13 090	LPS 220 Edge section - for covering thicknesses 7 - 16 mm.	21 mm	90 cm SB	sahara	14,45
222 23 11 270	LPS 220 Edge section - for covering thicknesses 7 - 16 mm.	21 mm	270 cm SB	silver	39,70
222 13 11 100	LPS 220 Edge section - for covering thicknesses 7 - 16 mm.	21 mm	100 cm SB	silver	15,70
222 23 11 090	LPS 220 Edge section - for covering thicknesses 7 - 16 mm.	21 mm	90 cm SB	silver	14,05
222 23 12 270	LPS 220 Edge section - for covering thicknesses 7 - 16 mm.	21 mm	270 cm SB	bronze	42,15
222 13 12 100	LPS 220 Edge section - for covering thicknesses 7 - 16 mm.	21 mm	100 cm SB	bronze	16,50
222 23 12 090	LPS 220 Edge section - for covering thicknesses 7 - 16 mm.	21 mm	90 cm SB	bronze	14,85
222 23 14 270	LPS 220 Edge section - for covering thicknesses 7 - 16 mm.	21 mm	270 cm SB	stainless steel matt	42,15

Schets	Artikelnummer	Omschrijving	Afmeting	Lengte	Kleur	Bruto verkoopprijs / st.
	222 13 14 100	LPS 220 Edge section - for covering thicknesses 7 - 16 mm.	21 mm	100 cm SB	stainless steel matt	16,50
	222 23 14 090	LPS 220 Edge section - for covering thicknesses 7 - 16 mm.	21 mm	90 cm SB	stainless steel matt	14,85
	222 23 17 270	LPS 220 Edge section - for covering thicknesses 7 - 16 mm.	21 mm	270 cm SB	black anodised	45,10
	222 13 17 100	LPS 220 Edge section - for covering thicknesses 7 - 16 mm.	21 mm	100 cm SB	black anodised	17,65
	232 23 13 270	LPS 220 Edge section - for covering thicknesses 7 - 16 mm - incl. expanded base section	21 mm	270 cm SB	sahara	50,25
	232 13 13 100	LPS 220 Edge section - for covering thicknesses 7 - 16 mm - incl. expanded base section	21 mm	100 cm SB	sahara	19,55

Schets	Artikelnummer	Omschrijving	Afmeting	Lengte	Kleur	Bruto verkoopprijs / st.
	232 23 11 270	LPS 220 Edge section - for covering thicknesses 7 - 16 mm - incl. expanded base section	21 mm	270 cm SB	silver	48,90
	232 13 11 100	LPS 220 Edge section - for covering thicknesses 7 - 16 mm - incl. expanded base section	21 mm	100 cm SB	silver	19,00
	232 23 11 090	LPS 220 Edge section - for covering thicknesses 7 - 16 mm - incl. expanded base section	21 mm	90 cm SB	silver	17,20
	232 23 14 270	LPS 220 Edge section - for covering thicknesses 7 - 16 mm - incl. expanded base section	21 mm	270 cm SB	stainless steel matt	51,20
	232 13 14 100	LPS 220 Edge section - for covering thicknesses 7 - 16 mm - incl. expanded base section	21 mm	100 cm SB	stainless steel matt	20,05
	232 23 14 090	LPS 220 Edge section - for covering thicknesses 7 - 16 mm - incl. expanded base section	21 mm	90 cm SB	stainless steel matt	18,15

	241 23 06 270	LPS 220 Base section with long base - for covering thicknesses 7 - 16 mm.	45 x 9,4 mm	270 cm	aluminium natural	24,60
	241 13 06 100	LPS 220 Base section with long base - for covering thicknesses 7 - 16 mm.	45 x 9,4 mm	100 cm S	aluminium natural	10,10

	239 23 06 270	LPS 220 Base section - elevated model - for covering thicknesses 14 - 21 mm.	20,5 x 14,4 mm	270 cm	aluminium natural	22,55
	239 13 06 100	LPS 220 Base section - elevated model - for covering thicknesses 14 - 21 mm.	20,5 x 14,4 mm	100 cm S	aluminium natural	9,25

	223 23 13 270	LPS 220 Connection section - for covering thicknesses 14 - 21 mm.	34 mm	270 cm SB	sahara	53,35
	223 23 13 090	LPS 220 Connection section - for covering thicknesses 14 - 21 mm.	34 mm	90 cm SB	sahara	18,75
	223 23 11 270	LPS 220 Connection section - for covering thicknesses 14 - 21 mm.	34 mm	270 cm SB	silver	51,85
	223 23 11 090	LPS 220 Connection section - for covering thicknesses 14 - 21 mm.	34 mm	90 cm SB	silver	18,25
	223 23 14 270	LPS 220 Connection section - for covering thicknesses 14 - 21 mm.	34 mm	270 cm SB	stainless steel matt	54,95
	223 23 14 090	LPS 220 Connection section - for covering thicknesses 14 - 21 mm.	34 mm	90 cm SB	stainless steel matt	19,25

	224 23 13 270	LPS 220 Adaptation section - for covering thicknesses 14 - 21 mm.	44 mm	270 cm SB	sahara	61,85
	224 23 13 090	LPS 220 Adaptation section - for covering thicknesses 14 - 21 mm.	44 mm	90 cm SB	sahara	21,65
	224 23 11 270	LPS 220 Adaptation section - for covering thicknesses 14 - 21 mm.	44 mm	270 cm SB	silver	60,10
	224 23 11 090	LPS 220 Adaptation section - for covering thicknesses 14 - 21 mm.	44 mm	90 cm SB	silver	21,00
	224 23 14 270	LPS 220 Adaptation section - for covering thicknesses 14 - 21 mm.	44 mm	270 cm SB	stainless steel matt	63,05
	224 23 14 090	LPS 220 Adaptation section - for covering thicknesses 14 - 21 mm.	44 mm	90 cm SB	stainless steel matt	22,00

	225 23 13 270	LPS 220 Edge section - for covering thicknesses 14 - 21 mm.	21 mm	270 cm SB	sahara	48,75
	225 23 13 090	LPS 220 Edge section - for covering thicknesses 14 - 21 mm.	21 mm	90 cm SB	sahara	16,95
	225 23 11 270	LPS 220 Edge section - for covering thicknesses 14 - 21 mm.	21 mm	270 cm SB	silver	47,25
	225 23 11 090	LPS 220 Edge section - for covering thicknesses 14 - 21 mm.	21 mm	90 cm SB	silver	16,45

Schets	Artikelnummer	Omschrijving	Afmeting	Lengte	Kleur	Bruto verkoopprijs / st.
	225 23 14 270	LPS 220 Edge section - for covering thicknesses 14 - 21 mm.	21 mm	270 cm SB	stainless steel matt	49,70
	225 23 14 090	LPS 220 Edge section - for covering thicknesses 14 - 21 mm.	21 mm	90 cm SB	stainless steel matt	17,35

Prinz LPS 220 Stair nosings

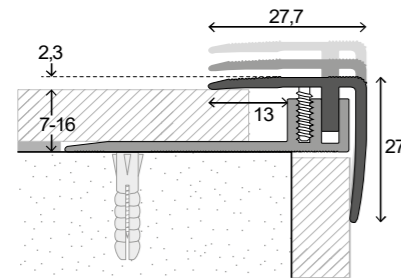

229 13 13 250	LPS 220 stair nosing - punched - for covering thicknesses 7 - 16 mm.	27,7 x 27 mm	250 cm SB	sahara	69,25
229 13 13 100	LPS 220 stair nosing - punched - for covering thicknesses 7 - 16 mm.	27,7 x 27 mm	100 cm SB	sahara	28,35
229 13 11 250	LPS 220 stair nosing - punched - for covering thicknesses 7 - 16 mm.	27,7 x 27 mm	250 cm SB	silver	67,40
229 13 11 100	LPS 220 stair nosing - punched - for covering thicknesses 7 - 16 mm.	27,7 x 27 mm	100 cm SB	silver	27,60
229 13 14 250	LPS 220 stair nosing - punched - for covering thicknesses 7 - 16 mm.	27,7 x 27 mm	250 cm SB	stainless steel matt	70,00
229 13 14 100	LPS 220 stair nosing - punched - for covering thicknesses 7 - 16 mm.	27,7 x 27 mm	100 cm SB	stainless steel matt	28,75

Prinz Profi-Tec MASTER System



- > Clip profile system with aluminium top-section and a base section made of impact-resistant PVC.
- > Continuously variable adaptation of both height and inclination.
- > Simple, fast and reliable installation - trouble-free disassembly and reusability.
- > Base and upper section are shrink-wrapped together.
- > We recommend gluing the base profile. No fixing material for the base profile enclosed.

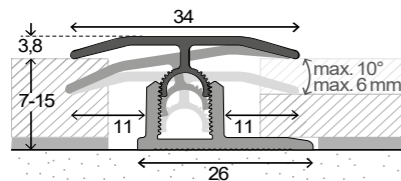

303 20 13 270	Profi-Tec MASTER Connection section - for covering thicknesses from 7 - 15 mm.	34 mm	270 cm SB	sahara	53,90
303 10 13 100	Profi-Tec MASTER Connection section - for covering thicknesses from 7 - 15 mm.	34 mm	100 cm SB	sahara	20,05
303 20 13 090	Profi-Tec MASTER Connection section - for covering thicknesses from 7 - 15 mm.	34 mm	90 cm SB	sahara	18,10
303 20 11 270	Profi-Tec MASTER Connection section - for covering thicknesses from 7 - 15 mm.	34 mm	270 cm SB	silver	53,90
303 10 11 100	Profi-Tec MASTER Connection section - for covering thicknesses from 7 - 15 mm.	34 mm	100 cm SB	silver	20,05
303 20 11 090	Profi-Tec MASTER Connection section - for covering thicknesses from 7 - 15 mm.	34 mm	90 cm SB	silver	18,10
303 20 14 270	Profi-Tec MASTER Connection section - for covering thicknesses from 7 - 15 mm.	34 mm	270 cm SB	stainless steel matt	56,70
303 10 14 100	Profi-Tec MASTER Connection section - for covering thicknesses from 7 - 15 mm.	34 mm	100 cm SB	stainless steel matt	21,10
303 20 14 090	Profi-Tec MASTER Connection section - for covering thicknesses from 7 - 15 mm.	34 mm	90 cm SB	stainless steel matt	19,00
303 20 19 270	Profi-Tec MASTER Connection section - for covering thicknesses from 7 - 15 mm.	34 mm	270 cm SB	stainless steel brushed	66,15
303 10 19 100	Profi-Tec MASTER Connection section - for covering thicknesses from 7 - 15 mm.	34 mm	100 cm SB	stainless steel brushed	24,90
303 20 19 090	Profi-Tec MASTER Connection section - for covering thicknesses from 7 - 15 mm.	34 mm	90 cm SB	stainless steel brushed	22,45
303 20 17 270	Profi-Tec MASTER Connection section - for covering thicknesses from 7 - 15 mm.	34 mm	270 cm SB	black anodised	66,15
303 10 17 100	Profi-Tec MASTER Connection section - for covering thicknesses from 7 - 15 mm.	34 mm	100 cm SB	black anodised	24,90
303 20 17 090	Profi-Tec MASTER Connection section - for covering thicknesses from 7 - 15 mm.	34 mm	90 cm SB	black anodised	22,45

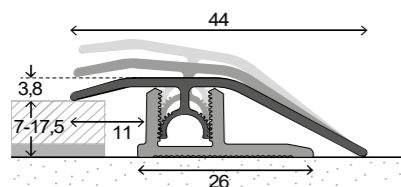

307 20 13 270	Profi-Tec MASTER Adaptation section - for covering thicknesses from 7 - 17,5 mm.	44 mm	270 cm SB	sahara	62,00
307 10 13 100	Profi-Tec MASTER Adaptation section - for covering thicknesses from 7 - 17,5 mm.	44 mm	100 cm SB	sahara	23,25
307 20 13 090	Profi-Tec MASTER Adaptation section - for covering thicknesses from 7 - 17,5 mm.	44 mm	90 cm SB	sahara	20,90
307 20 11 270	Profi-Tec MASTER Adaptation section - for covering thicknesses from 7 - 17,5 mm.	44 mm	270 cm SB	silver	62,00
307 10 11 100	Profi-Tec MASTER Adaptation section - for covering thicknesses from 7 - 17,5 mm.	44 mm	100 cm SB	silver	23,25
307 20 11 090	Profi-Tec MASTER Adaptation section - for covering thicknesses from 7 - 17,5 mm.	44 mm	90 cm SB	silver	20,90
307 20 14 270	Profi-Tec MASTER Adaptation section - for covering thicknesses from 7 - 17,5 mm.	44 mm	270 cm SB	stainless steel matt	65,90
307 10 14 100	Profi-Tec MASTER Adaptation section - for covering thicknesses from 7 - 17,5 mm.	44 mm	100 cm SB	stainless steel matt	24,90
307 20 14 090	Profi-Tec MASTER Adaptation section - for covering thicknesses from 7 - 17,5 mm.	44 mm	90 cm SB	stainless steel matt	22,35
307 20 19 270	Profi-Tec MASTER Adaptation section - for covering thicknesses from 7 - 17,5 mm.	44 mm	270 cm SB	stainless steel brushed	76,70
307 10 19 100	Profi-Tec MASTER Adaptation section - for covering thicknesses from 7 - 17,5 mm.	44 mm	100 cm SB	stainless steel brushed	28,55
307 20 19 090	Profi-Tec MASTER Adaptation section - for covering thicknesses from 7 - 17,5 mm.	44 mm	90 cm SB	stainless steel brushed	25,85

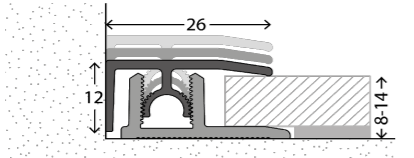
Schets	Artikelnummer	Omschrijving	Afmeting	Lengte	Kleur	Bruto verkoopprijs / st.
	307 20 17 270	Profi-Tec MASTER Adaptation section - for covering thicknesses from 7 - 17,5 mm.	44 mm	270 cm SB	black anodised	76,70
	307 10 17 100	Profi-Tec MASTER Adaptation section - for covering thicknesses from 7 - 17,5 mm.	44 mm	100 cm SB	black eloxiert	28,55
	307 20 17 090	Profi-Tec MASTER Adaptation section - for covering thicknesses from 7 - 17,5 mm.	44 mm	90 cm SB	black anodised	25,85
	313 20 13 270	Profi-Tec MASTER Edge section - f or covering thicknesses 8 - 14 mm.	28 mm	270 cm SB	sahara	50,40
	313 10 13 100	Profi-Tec MASTER Edge section - f or covering thicknesses 8 - 14 mm.	28 mm	100 cm SB	sahara	18,95
	313 20 13 090	Profi-Tec MASTER Edge section - f or covering thicknesses 8 - 14 mm.	28 mm	90 cm SB	sahara	17,10
	313 20 11 270	Profi-Tec MASTER Edge section - f or covering thicknesses 8 - 14 mm.	28 mm	270 cm SB	silver	50,40
	313 10 11 100	Profi-Tec MASTER Edge section - f or covering thicknesses 8 - 14 mm.	28 mm	100 cm SB	silver	18,95
	313 20 11 090	Profi-Tec MASTER Edge section - f or covering thicknesses 8 - 14 mm.	28 mm	90 cm SB	silver	17,10
	313 20 14 270	Profi-Tec MASTER Edge section - f or covering thicknesses 8 - 14 mm.	28 mm	270 cm SB	stainless steel matt	53,20
	313 10 14 100	Profi-Tec MASTER Edge section - f or covering thicknesses 8 - 14 mm.	28 mm	100 cm SB	stainless steel matt	19,95
	313 20 14 090	Profi-Tec MASTER Edge section - f or covering thicknesses 8 - 14 mm.	28 mm	90 cm SB	stainless steel matt	17,95
	313 20 19 270	Profi-Tec MASTER Edge section - f or covering thicknesses 8 - 14 mm.	28 mm	270 cm SB	stainless steel brushed	62,00
	313 10 19 100	Profi-Tec MASTER Edge section - f or covering thicknesses 8 - 14 mm.	28 mm	100 cm SB	stainless steel brushed	23,15
	313 20 19 090	Profi-Tec MASTER Edge section - f or covering thicknesses 8 - 14 mm.	28 mm	90 cm SB	stainless steel brushed	20,90
	313 20 17 270	Profi-Tec MASTER Edge section - f or covering thicknesses 8 - 14 mm.	28 mm	270 cm SB	black anodised	62,00
313 10 17 100	Profi-Tec MASTER Edge section - f or covering thicknesses 8 - 14 mm.	28 mm	100 cm SB	black anodised	23,15	
313 20 17 090	Profi-Tec MASTER Edge section - f or covering thicknesses 8 - 14 mm.	28 mm	90 cm SB	black anodised	20,90	

> for multilayer floor coverings with laminated impact sound insulation

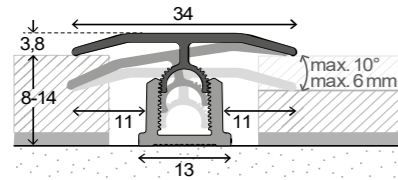

335 10 11 200	Profi-Tec CORE Connection section - for covering thicknesses 8 - 14 mm.	34 mm	200 cm SB	silver	40,90
335 10 14 200	Profi-Tec CORE Connection section - for covering thicknesses 8 - 14 mm.	34 mm	200 cm SB	stainless steel matt	43,20
335 10 17 200	Profi-Tec CORE Connection section - for covering thicknesses 8 - 14 mm.	34 mm	200 cm SB	black anodised	50,20
335 10 19 200	Profi-Tec CORE Connection section - for covering thicknesses 8 - 14 mm.	34 mm	200 cm SB	stainless steel brushed	50,20

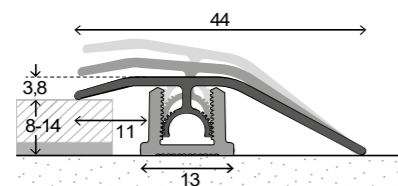

336 10 11 200	Profi-Tec CORE Adaptation section - for covering thicknesses 8 - 14 mm.	44 mm	200 cm SB	silver	47,00
336 10 14 200	Profi-Tec CORE Adaptation section - for covering thicknesses 8 - 14 mm.	44 mm	200 cm SB	stainless steel matt	50,00
336 10 17 200	Profi-Tec CORE Adaptation section - for covering thicknesses 8 - 14 mm.	44 mm	200 cm SB	black anodised	58,20
336 10 19 200	Profi-Tec CORE Adaptation section - for covering thicknesses 8 - 14 mm.	44 mm	200 cm SB	stainless steel brushed	58,20

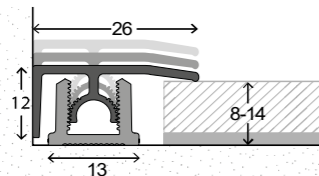

337 10 11 200	Profi-Tec CORE Edge section - for covering thicknesses 8 - 14 mm.	26 mm	200 cm SB	silver	38,20
337 10 14 200	Profi-Tec CORE Edge section - for covering thicknesses 8 - 14 mm.	26 mm	200 cm SB	stainless steel matt	40,50
337 10 17 200	Profi-Tec CORE Edge section - for covering thicknesses 8 - 14 mm.	26 mm	200 cm SB	black anodised	47,10
337 10 19 200	Profi-Tec CORE Edge section - for covering thicknesses 8 - 14 mm.	26 mm	200 cm SB	stainless steel brushed	47,10

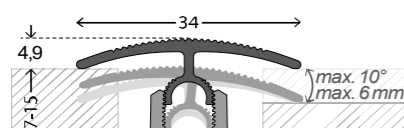

300 20 10 270	Profi-Tec MASTER Connection section - for covering thicknesses from 7 - 15 mm.	34 mm	270 cm SB	gold	53,90
300 10 10 100	Profi-Tec MASTER Connection section - for covering thicknesses from 7 - 15 mm.	34 mm	100 cm SB	gold	20,05
300 20 10 090	Profi-Tec MASTER Connection section - for covering thicknesses from 7 - 15 mm.	34 mm	90 cm SB	gold	18,10
300 20 13 270	Profi-Tec MASTER Connection section - for covering thicknesses from 7 - 15 mm.	34 mm	270 cm SB	sahara	53,90
300 10 13 100	Profi-Tec MASTER Connection section - for covering thicknesses from 7 - 15 mm.	34 mm	100 cm SB	sahara	20,05

Schets	Artikelnummer	Omschrijving	Afmeting	Lengte	Kleur	Bruto verkoopprijs / st.
	300 20 13 090	Profi-Tec MASTER Connection section - for covering thicknesses from 7 - 15 mm.	34 mm	90 cm SB	sahara	18,10
	300 20 11 270	Profi-Tec MASTER Connection section - for covering thicknesses from 7 - 15 mm.	34 mm	270 cm SB	silver	53,90
	300 10 11 100	Profi-Tec MASTER Connection section - for covering thicknesses from 7 - 15 mm.	34 mm	100 cm SB	silver	20,05
	300 20 11 090	Profi-Tec MASTER Connection section - for covering thicknesses from 7 - 15 mm.	34 mm	90 cm SB	silver	18,10
	300 20 12 270	Profi-Tec MASTER Connection section - for covering thicknesses from 7 - 15 mm.	34 mm	270 cm SB	bronze	56,70
	300 10 12 100	Profi-Tec MASTER Connection section - for covering thicknesses from 7 - 15 mm.	34 mm	100 cm SB	bronze	21,10
	300 20 12 090	Profi-Tec MASTER Connection section - for covering thicknesses from 7 - 15 mm.	34 mm	90 cm SB	bronze	19,00
	300 20 14 270	Profi-Tec MASTER Connection section - for covering thicknesses from 7 - 15 mm.	34 mm	270 cm SB	stainless steel matt	56,70
	300 10 14 100	Profi-Tec MASTER Connection section - for covering thicknesses from 7 - 15 mm.	34 mm	100 cm SB	stainless steel matt	21,10
	300 20 14 090	Profi-Tec MASTER Connection section - for covering thicknesses from 7 - 15 mm.	34 mm	90 cm SB	stainless steel matt	19,00
	300 20 09 270	Profi-Tec MASTER Connection section - for covering thicknesses from 7 - 15 mm.	34 mm	270 cm SB	stainless steel polished	66,15
	300 10 09 100	Profi-Tec MASTER Connection section - for covering thicknesses from 7 - 15 mm.	34 mm	100 cm SB	stainless steel polished	24,90
	300 20 09 090	Profi-Tec MASTER Connection section - for covering thicknesses from 7 - 15 mm.	34 mm	90 cm SB	stainless steel polished	22,45
	301 20 20 270	Profi-Tec MASTER Connection section - for covering thicknesses from 7 - 15 mm.	34 mm	270 cm SB	beech	59,95
301 10 20 100	Profi-Tec MASTER Connection section - for covering thicknesses from 7 - 15 mm.	34 mm	100 cm SB	beech	22,80	
301 20 20 090	Profi-Tec MASTER Connection section - for covering thicknesses from 7 - 15 mm.	34 mm	90 cm SB	beech	20,35	
301 20 21 270	Profi-Tec MASTER Connection section - for covering thicknesses from 7 - 15 mm.	34 mm	270 cm SB	dark oak	59,95	
301 20 21 090	Profi-Tec MASTER Connection section - for covering thicknesses from 7 - 15 mm.	34 mm	90 cm SB	dark oak	20,35	
301 20 25 270	Profi-Tec MASTER Connection section - for covering thicknesses from 7 - 15 mm.	34 mm	270 cm SB	light oak	59,95	
301 10 25 100	Profi-Tec MASTER Connection section - for covering thicknesses from 7 - 15 mm.	34 mm	100 cm SB	light oak	22,80	
301 20 25 090	Profi-Tec MASTER Connection section - for covering thicknesses from 7 - 15 mm.	34 mm	90 cm SB	light oak	22,80	
301 20 22 270	Profi-Tec MASTER Connection section - for covering thicknesses from 7 - 15 mm.	34 mm	270 cm SB	maple	59,95	
301 20 22 090	Profi-Tec MASTER Connection section - for covering thicknesses from 7 - 15 mm.	34 mm	90 cm SB	maple	22,80	
301 20 24 270	Profi-Tec MASTER Connection section - for covering thicknesses from 7 - 15 mm.	34 mm	270 cm SB	walnut	59,95	
301 20 24 090	Profi-Tec MASTER Connection section - for covering thicknesses from 7 - 15 mm.	34 mm	90 cm SB	walnut	22,80	

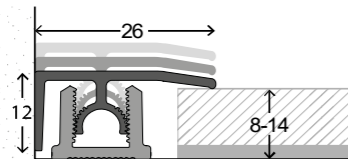

314 20 11 270	Profi-Tec MASTER Connection section - for covering thicknesses from 12 - 17,5 mm.	34 mm	270 cm SB	silver	53,90
314 20 11 090	Profi-Tec MASTER Connection section - for covering thicknesses from 12 - 17,5 mm.	34 mm	90 cm SB	silver	18,10
314 20 14 270	Profi-Tec MASTER Connection section - for covering thicknesses from 12 - 17,5 mm.	34 mm	270 cm SB	stainless steel matt	56,70
314 20 14 090	Profi-Tec MASTER Connection section - for covering thicknesses from 12 - 17,5 mm.	34 mm	90 cm SB	stainless steel matt	19,00

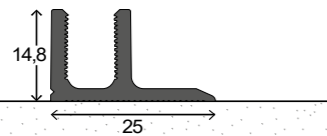

> Combined with Profi-Tec Connection section 34 mm for covering thicknesses from 12 - 17,5 mm.

> Combined with Profi-Tec Border section 28 mm for covering thicknesses from 12 - 17,5 mm.

242 23 41 270	Base Section PVC - for Connection and Edge section.	14,8 mm	270 cm		23,50
242 13 41 100	Base Section PVC - for Connection and Edge section.	14,8 mm	100 cm SB		8,90
242 23 41 090	Base Section PVC - for Connection and Edge section.	14,8 mm	90 cm SB		8,30

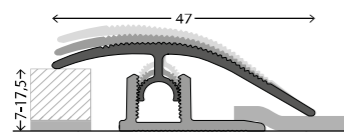

304 20 10 270	Profi-Tec MASTER Adaptation section - for covering thicknesses from 7 - 17,5 mm.	47 mm	270 cm SB	gold	62,00
304 10 10 100	Profi-Tec MASTER Adaptation section - for covering thicknesses from 7 - 17,5 mm.	47 mm	100 cm SB	gold	23,25
304 20 10 090	Profi-Tec MASTER Adaptation section - for covering thicknesses from 7 - 17,5 mm.	47 mm	90 cm SB	gold	20,90
304 20 13 270	Profi-Tec MASTER Adaptation section - for covering thicknesses from 7 - 17,5 mm.	47 mm	270 cm SB	sahara	62,00
304 10 13 100	Profi-Tec MASTER Adaptation section - for covering thicknesses from 7 - 17,5 mm.	47 mm	100 cm SB	sahara	23,25
304 20 13 090	Profi-Tec MASTER Adaptation section - for covering thicknesses from 7 - 17,5 mm.	47 mm	90 cm SB	sahara	20,90
304 20 11 270	Profi-Tec MASTER Adaptation section - for covering thicknesses from 7 - 17,5 mm.	47 mm	270 cm SB	silver	62,00
304 10 11 100	Profi-Tec MASTER Adaptation section - for covering thicknesses from 7 - 17,5 mm.	47 mm	100 cm SB	silver	23,25
304 20 11 090	Profi-Tec MASTER Adaptation section - for covering thicknesses from 7 - 17,5 mm.	47 mm	90 cm SB	silver	20,90
304 20 12 270	Profi-Tec MASTER Adaptation section - for covering thicknesses from 7 - 17,5 mm.	47 mm	270 cm SB	bronze	65,90
304 10 12 100	Profi-Tec MASTER Adaptation section - for covering thicknesses from 7 - 17,5 mm.	47 mm	100 cm SB	bronze	24,90

Schets	Artikelnummer	Omschrijving	Afmeting	Lengte	Kleur	Bruto verkoopprijs / st.
	304 20 12 090	Profi-Tec MASTER Adaptation section - for covering thicknesses from 7 - 17,5 mm.	47 mm	90 cm SB	bronze	22,35
	304 20 14 270	Profi-Tec MASTER Adaptation section - for covering thicknesses from 7 - 17,5 mm.	47 mm	270 cm SB	stainless steel matt	65,90
	304 10 14 100	Profi-Tec MASTER Adaptation section - for covering thicknesses from 7 - 17,5 mm.	47 mm	100 cm SB	stainless steel matt	24,90
	304 20 14 090	Profi-Tec MASTER Adaptation section - for covering thicknesses from 7 - 17,5 mm.	47 mm	90 cm SB	stainless steel matt	22,35
	304 20 09 270	Profi-Tec MASTER Adaptation section - for covering thicknesses from 7 - 17,5 mm.	47 mm	270 cm SB	stainless steel polished	76,70
	304 10 09 100	Profi-Tec MASTER Adaptation section - for covering thicknesses from 7 - 17,5 mm.	47 mm	100 cm SB	stainless steel polished	28,55
	304 20 09 090	Profi-Tec MASTER Adaptation section - for covering thicknesses from 7 - 17,5 mm.	47 mm	90 cm SB	stainless steel polished	25,85
	305 10 20 100	Profi-Tec MASTER Adaptation section - for covering thicknesses from 7 - 17,5 mm.	47 mm	100 cm SB	beech	24,90
	305 20 20 090	Profi-Tec MASTER Adaptation section - for covering thicknesses from 7 - 17,5 mm.	47 mm	90 cm SB	beech	22,40
	305 20 21 090	Profi-Tec MASTER Adaptation section - for covering thicknesses from 7 - 17,5 mm.	47 mm	90 cm SB	dark oak	22,40
	305 10 25 100	Profi-Tec MASTER Adaptation section - for covering thicknesses from 7 - 17,5 mm.	47 mm	100 cm SB	light oak	24,90
	305 20 25 090	Profi-Tec MASTER Adaptation section - for covering thicknesses from 7 - 17,5 mm.	47 mm	90 cm SB	light oak	22,40
	305 20 22 090	Profi-Tec MASTER Adaptation section - for covering thicknesses from 7 - 17,5 mm.	47 mm	90 cm SB	maple	22,40
	305 20 24 090	Profi-Tec MASTER Adaptation section - for covering thicknesses from 7 - 17,5 mm.	47 mm	90 cm SB	walnut	22,40
	308 20 10 270	Profi-Tec MASTER Edge section - for covering thicknesses from 8 - 14 mm.	28 mm	270 cm SB	gold	50,40
	308 10 10 100	Profi-Tec MASTER Edge section - for covering thicknesses from 8 - 14 mm.	28 mm	100 cm SB	gold	18,95
	308 20 10 090	Profi-Tec MASTER Edge section - for covering thicknesses from 8 - 14 mm.	28 mm	90 cm SB	gold	17,10
	308 20 13 270	Profi-Tec MASTER Edge section - for covering thicknesses from 8 - 14 mm.	28 mm	270 cm SB	sahara	50,40
	308 10 13 100	Profi-Tec MASTER Edge section - for covering thicknesses from 8 - 14 mm.	28 mm	100 cm SB	sahara	18,95
	308 20 13 090	Profi-Tec MASTER Edge section - for covering thicknesses from 8 - 14 mm.	28 mm	90 cm SB	sahara	17,10
	308 20 11 270	Profi-Tec MASTER Edge section - for covering thicknesses from 8 - 14 mm.	28 mm	270 cm SB	silver	50,40
	308 10 11 100	Profi-Tec MASTER Edge section - for covering thicknesses from 8 - 14 mm.	28 mm	100 cm SB	silver	18,95
	308 20 11 090	Profi-Tec MASTER Edge section - for covering thicknesses from 8 - 14 mm.	28 mm	90 cm SB	silver	17,10
	308 20 12 270	Profi-Tec MASTER Edge section - for covering thicknesses from 8 - 14 mm.	28 mm	270 cm SB	bronze	53,20
	308 20 14 270	Profi-Tec MASTER Edge section - for covering thicknesses from 8 - 14 mm.	28 mm	270 cm SB	stainless steel matt	53,20
	308 10 14 100	Profi-Tec MASTER Edge section - for covering thicknesses from 8 - 14 mm.	28 mm	100 cm SB	stainless steel matt	19,95
	308 20 14 090	Profi-Tec MASTER Edge section - for covering thicknesses from 8 - 14 mm.	28 mm	90 cm SB	stainless steel matt	17,95
	308 20 09 270	Profi-Tec MASTER Edge section - for covering thicknesses from 8 - 14 mm.	28 mm	270 cm SB	stainless steel polished	62,00
	308 10 09 100	Profi-Tec MASTER Edge section - for covering thicknesses from 8 - 14 mm.	28 mm	100 cm SB	stainless steel polished	23,15
	308 20 09 090	Profi-Tec MASTER Edge section - for covering thicknesses from 8 - 14 mm.	28 mm	90 cm SB	stainless steel polished	20,90
	310 20 11 270	Profi-Tec MASTER Edge section - for covering thicknesses from 12 - 17,5 mm.	28 mm	270 cm SB	silver	51,75
	310 10 11 100	Profi-Tec MASTER Edge section - for covering thicknesses from 12 - 17,5 mm.	28 mm	100 cm SB	silver	19,50
	310 20 14 270	Profi-Tec MASTER Edge section - for covering thicknesses from 12 - 17,5 mm.	28 mm	270 cm SB	stainless steel matt	54,85
	310 10 14 100	Profi-Tec MASTER Edge section - for covering thicknesses from 12 - 17,5 mm.	28 mm	100 cm SB	stainless steel matt	20,50

> Combined with Profi-Tec Connection section 34 mm for covering thicknesses from 12 - 17,5 mm.

> Combined with Profi-Tec Border section 28 mm for covering thicknesses from 12 - 17,5 mm.

242 23 41 270	Base Section PVC - for Connection and Edge section.	14,8 mm	270 cm		23,50
242 13 41 100	Base Section PVC - for Connection and Edge section.	14,8 mm	100 cm SB		8,90
242 23 41 090	Base Section PVC - for Connection and Edge section.	14,8 mm	90 cm SB		8,30

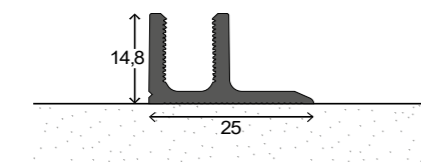

Prinz Profi-Tec XXL System

> Clip profile system with aluminium top-section and PVC base section.



Schets	Artikelnummer	Omschrijving	Afmeting	Lengte	Kleur	Bruto verkoopprijs / st.
--------	---------------	--------------	----------	--------	-------	--------------------------

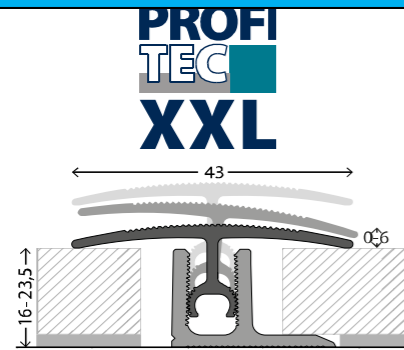

- > For covering thicknesses 16 – 23,5 mm.
- > Continuously variable adaptation of both height and inclination.
- > Simple, fast and reliable installation - trouble-free disassembly and reusability.
- > Base and upper section are shrink-wrapped together.
- > We recommend gluing the base profile. No fixing material for the base profile enclosed.



302 20 11 270	Profi-Tec XXL Connection section - for covering thicknesses from 16 - 23,5 mm.	43 mm	270 cm	SB	silver	62,10
302 20 11 090	Profi-Tec XXL Connection section - for covering thicknesses from 16 - 23,5 mm.	43 mm	90 cm	SB	silver	21,60
302 20 14 270	Profi-Tec XXL Connection section - for covering thicknesses from 16 - 23,5 mm.	43 mm	270 cm	SB	stainless steel matt	66,45
302 20 14 090	Profi-Tec XXL Connection section - for covering thicknesses from 16 - 23,5 mm.	43 mm	90 cm	SB	stainless steel matt	23,10

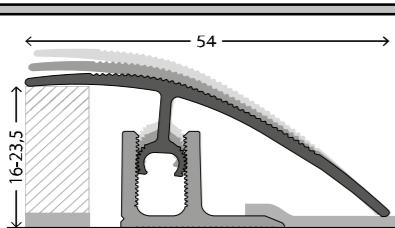

306 20 11 270	Profi-Tec XXL Adaptation section - for covering thicknesses from 16 - 23,5 mm.	54 mm	270 cm	SB	silver	74,55
306 20 11 090	Profi-Tec XXL Adaptation section - for covering thicknesses from 16 - 23,5 mm.	54 mm	90 cm	SB	silver	25,35
306 20 14 270	Profi-Tec XXL Adaptation section - for covering thicknesses from 16 - 23,5 mm.	54 mm	270 cm	SB	stainless steel matt	80,60
306 20 14 090	Profi-Tec XXL Adaptation section - for covering thicknesses from 16 - 23,5 mm.	54 mm	90 cm	SB	stainless steel matt	28,00

Prinz Profi-Tec JUNIOR System

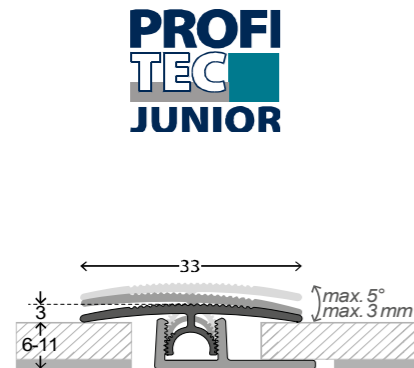

- > Clip profile system with aluminium top-section and PVC base section.
- > For covering thicknesses 6 – 11 mm.
- > Continuously variable adaptation of both height and inclination.
- > Simple, fast and reliable installation - trouble-free disassembly and reusability.
- > Base and upper section are shrink-wrapped together.
- > We recommend gluing the base profile. No fixing material for the base profile enclosed.



316 20 13 270	Profi-Tec JUNIOR Connection section - for covering thicknesses from 6 - 11 mm.	33 mm	270 cm	SB	sahara	39,15
316 10 13 100	Profi-Tec JUNIOR Connection section - for covering thicknesses from 6 - 11 mm.	33 mm	100 cm	SB	sahara	14,70
316 20 13 090	Profi-Tec JUNIOR Connection section - for covering thicknesses from 6 - 11 mm.	33 mm	90 cm	SB	sahara	13,30
316 20 11 270	Profi-Tec JUNIOR Connection section - for covering thicknesses from 6 - 11 mm.	33 mm	270 cm	SB	silver	39,15
316 10 11 100	Profi-Tec JUNIOR Connection section - for covering thicknesses from 6 - 11 mm.	33 mm	100 cm	SB	silver	14,70
316 20 11 090	Profi-Tec JUNIOR Connection section - for covering thicknesses from 6 - 11 mm.	33 mm	90 cm	SB	silver	13,30
316 20 14 270	Profi-Tec JUNIOR Connection section - for covering thicknesses from 6 - 11 mm.	33 mm	270 cm	SB	stainless steel matt	41,60
316 10 14 100	Profi-Tec JUNIOR Connection section - for covering thicknesses from 6 - 11 mm.	33 mm	100 cm	SB	stainless steel matt	15,65
316 20 14 090	Profi-Tec JUNIOR Connection section - for covering thicknesses from 6 - 11 mm.	33 mm	90 cm	SB	stainless steel matt	14,30

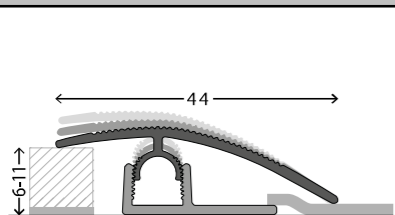

318 20 13 270	Profi-Tec JUNIOR Adaptation section - for covering thicknesses from 6 - 11 mm.	44 mm	270 cm	SB	sahara	44,70
318 10 13 100	Profi-Tec JUNIOR Adaptation section - for covering thicknesses from 6 - 11 mm.	44 mm	100 cm	SB	sahara	17,15
318 20 13 090	Profi-Tec JUNIOR Adaptation section - for covering thicknesses from 6 - 11 mm.	44 mm	90 cm	SB	sahara	15,60
318 20 11 270	Profi-Tec JUNIOR Adaptation section - for covering thicknesses from 6 - 11 mm.	44 mm	270 cm	SB	silver	44,70
318 10 11 100	Profi-Tec JUNIOR Adaptation section - for covering thicknesses from 6 - 11 mm.	44 mm	100 cm	SB	silver	17,15
318 20 11 090	Profi-Tec JUNIOR Adaptation section - for covering thicknesses from 6 - 11 mm.	44 mm	90 cm	SB	silver	15,60
318 20 14 270	Profi-Tec JUNIOR Adaptation section - for covering thicknesses from 6 - 11 mm.	44 mm	270 cm	SB	stainless steel matt	46,85
318 10 14 100	Profi-Tec JUNIOR Adaptation section - for covering thicknesses from 6 - 11 mm.	44 mm	100 cm	SB	stainless steel matt	18,35
318 20 14 090	Profi-Tec JUNIOR Adaptation section - for covering thicknesses from 6 - 11 mm.	44 mm	90 cm	SB	stainless steel matt	16,45

320 20 13 270	Profi-Tec JUNIOR Edge section - for covering thicknesses from 6 - 11 mm.	26 mm	270 cm	SB	sahara	37,70
320 10 13 100	Profi-Tec JUNIOR Edge section - for covering thicknesses from 6 - 11 mm.	26 mm	100 cm	SB	sahara	14,40

Schets	Artikelnummer	Omschrijving	Afmeting	Lengte	Kleur	Bruto verkoopprijs / st.
	320 20 13 090	Profi-Tec JUNIOR Edge section - for covering thicknesses from 6 - 11 mm.	26 mm	90 cm SB	sahara	13,05
	320 20 11 270	Profi-Tec JUNIOR Edge section - for covering thicknesses from 6 - 11 mm.	26 mm	270 cm SB	silver	37,70
	320 10 11 100	Profi-Tec JUNIOR Edge section - for covering thicknesses from 6 - 11 mm.	26 mm	100 cm SB	silver	14,40
	320 20 11 090	Profi-Tec JUNIOR Edge section - for covering thicknesses from 6 - 11 mm.	26 mm	90 cm SB	silver	13,05
	320 20 14 270	Profi-Tec JUNIOR Edge section - for covering thicknesses from 6 - 11 mm.	26 mm	270 cm SB	stainless steel matt	40,00
	320 10 14 100	Profi-Tec JUNIOR Edge section - for covering thicknesses from 6 - 11 mm.	26 mm	100 cm SB	stainless steel matt	15,20
	320 20 14 090	Profi-Tec JUNIOR Edge section - for covering thicknesses from 6 - 11 mm.	26 mm	90 cm SB	stainless steel matt	13,75

Eco-Clip profile system



- > Clip-profile-system with aluminium top section and plastic base section.
- > Suitable for covering thicknesses from 6 - 12 mm.
- > Automatic adaptation of both height and inclination.
- > Base and top section are shrink-packed together.
- > We recommend gluing the base profile. No fixing material for the base profile enclosed.
- > DBGM 20 2019 100 871

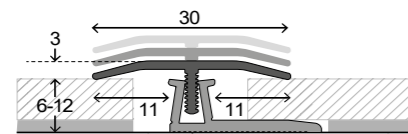

440 20 13 270	Eco-Clip connection section - for covering thicknesses 6 - 12 mm.	30 mm	270 cm SB	sahara	36,20
440 10 13 100	Eco-Clip connection section - for covering thicknesses 6 - 12 mm.	30 mm	100 cm SB	sahara	13,55
440 20 13 090	Eco-Clip connection section - for covering thicknesses 6 - 12 mm.	30 mm	90 cm SB	sahara	12,30
440 20 11 270	Eco-Clip connection section - for covering thicknesses 6 - 12 mm.	30 mm	270 cm SB	silver	35,25
440 10 11 100	Eco-Clip connection section - for covering thicknesses 6 - 12 mm.	30 mm	100 cm SB	silver	13,20
440 20 11 090	Eco-Clip connection section - for covering thicknesses 6 - 12 mm.	30 mm	90 cm SB	silver	11,95
440 20 14 270	Eco-Clip connection section - for covering thicknesses 6 - 12 mm.	30 mm	270 cm SB	stainless steel matt	37,40
440 10 14 100	Eco-Clip connection section - for covering thicknesses 6 - 12 mm.	30 mm	100 cm SB	stainless steel matt	14,10
440 20 14 090	Eco-Clip connection section - for covering thicknesses 6 - 12 mm.	30 mm	90 cm SB	stainless steel matt	12,85

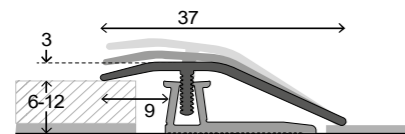

441 20 13 270	Eco-Clip adaptation section - for covering thicknesses 6 - 12 mm.	37 mm	270 cm SB	sahara	40,00
441 10 13 100	Eco-Clip adaptation section - for covering thicknesses 6 - 12 mm.	37 mm	100 cm SB	sahara	15,30
441 20 13 090	Eco-Clip adaptation section - for covering thicknesses 6 - 12 mm.	37 mm	90 cm SB	sahara	13,95
441 20 11 270	Eco-Clip adaptation section - for covering thicknesses 6 - 12 mm.	37 mm	270 cm SB	silver	38,90
441 10 11 100	Eco-Clip adaptation section - for covering thicknesses 6 - 12 mm.	37 mm	100 cm SB	silver	14,90
441 20 11 090	Eco-Clip adaptation section - for covering thicknesses 6 - 12 mm.	37 mm	90 cm SB	silver	13,55
441 20 14 270	Eco-Clip adaptation section - for covering thicknesses 6 - 12 mm.	37 mm	270 cm SB	stainless steel matt	40,80
441 10 14 100	Eco-Clip adaptation section - for covering thicknesses 6 - 12 mm.	37 mm	100 cm SB	stainless steel matt	15,95
441 20 14 090	Eco-Clip adaptation section - for covering thicknesses 6 - 12 mm.	37 mm	90 cm SB	stainless steel matt	14,35

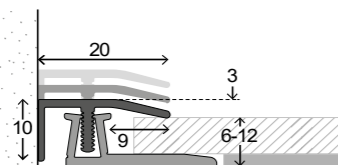

442 20 13 270	Eco-Clip Edge section - for covering thicknesses 6 - 12 mm.	20 x 10 mm	270 cm SB	sahara	33,75
442 10 13 100	Eco-Clip Edge section - for covering thicknesses 6 - 12 mm.	20 x 10 mm	100 cm SB	sahara	12,90
442 20 13 090	Eco-Clip Edge section - for covering thicknesses 6 - 12 mm.	20 x 10 mm	90 cm SB	sahara	11,65
442 20 11 270	Eco-Clip Edge section - for covering thicknesses 6 - 12 mm.	20 x 10 mm	270 cm SB	silver	32,85
442 10 11 100	Eco-Clip Edge section - for covering thicknesses 6 - 12 mm.	20 x 10 mm	100 cm SB	silver	12,50
442 20 11 090	Eco-Clip Edge section - for covering thicknesses 6 - 12 mm.	20 x 10 mm	90 cm SB	silver	11,30
442 20 14 270	Eco-Clip Edge section - for covering thicknesses 6 - 12 mm.	20 x 10 mm	270 cm SB	stainless steel matt	34,85
442 10 14 100	Eco-Clip Edge section - for covering thicknesses 6 - 12 mm.	20 x 10 mm	100 cm SB	stainless steel matt	13,25
442 20 14 090	Eco-Clip Edge section - for covering thicknesses 6 - 12 mm.	20 x 10 mm	90 cm SB	stainless steel matt	11,95

Prinz LPS Design System



- > Screw profile system with aluminium top-section and aluminium base section.
- > Perfectly suitable for design floorings with thicknesses 3,5 - 8,5 mm.
- > Incl. TORX screws.
- > Base and upper section are shrink-wrapped together.

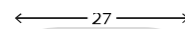

326 23 13 270	LPS Design Connection section - for covering thicknesses 3,5 - 8,5 mm.	27 mm	270 cm SB	sahara	43,10
326 13 13 100	LPS Design Connection section - for covering thicknesses 3,5 - 8,5 mm.	27 mm	100 cm SB	sahara	17,05

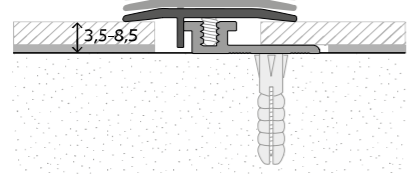
Schets	Artikelnummer	Omschrijving	Afmeting	Lengte	Kleur	Bruto verkoopprijs / st.
	326 23 13 090	LPS Design Connection section - for covering thicknesses 3,5 - 8,5 mm.	27 mm	90 cm SB	sahara	15,50
	326 23 11 270	LPS Design Connection section - for covering thicknesses 3,5 - 8,5 mm.	27 mm	270 cm SB	silver	43,10
	326 13 11 100	LPS Design Connection section - for covering thicknesses 3,5 - 8,5 mm.	27 mm	100 cm SB	silver	17,05
	326 23 11 090	LPS Design Connection section - for covering thicknesses 3,5 - 8,5 mm.	27 mm	90 cm SB	silver	15,50
	326 23 14 270	LPS Design Connection section - for covering thicknesses 3,5 - 8,5 mm.	27 mm	270 cm SB	stainless steel matt	44,45
	326 13 14 100	LPS Design Connection section - for covering thicknesses 3,5 - 8,5 mm.	27 mm	100 cm SB	stainless steel matt	17,55
	326 23 14 090	LPS Design Connection section - for covering thicknesses 3,5 - 8,5 mm.	27 mm	90 cm SB	stainless steel matt	15,95
	326 23 09 270	LPS Design Connection section - for covering thicknesses 3,5 - 8,5 mm.	27 mm	270 cm SB	stainless steel polished	53,90
	326 13 09 100	LPS Design Connection section - for covering thicknesses 3,5 - 8,5 mm.	27 mm	100 cm SB	stainless steel polished	21,30
	326 23 09 090	LPS Design Connection section - for covering thicknesses 3,5 - 8,5 mm.	27 mm	90 cm SB	stainless steel polished	19,25
	326 23 19 270	LPS Design Connection section - for covering thicknesses 3,5 - 8,5 mm.	27 mm	270 cm SB	stainless steel brushed	53,90
	326 13 19 100	LPS Design Connection section - for covering thicknesses 3,5 - 8,5 mm.	27 mm	100 cm SB	stainless steel brushed	21,30
	326 23 19 090	LPS Design Connection section - for covering thicknesses 3,5 - 8,5 mm.	27 mm	90 cm SB	stainless steel brushed	19,25

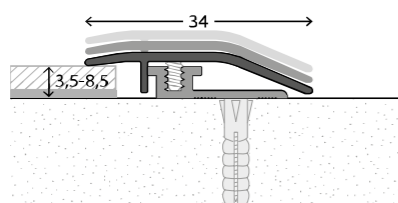
	327 23 13 270	LPS Design Adaptation section - for covering thicknesses 3,5 - 8,5 mm.	34 mm	270 cm SB	sahara	46,20
	327 13 13 100	LPS Design Adaptation section - for covering thicknesses 3,5 - 8,5 mm.	34 mm	100 cm SB	sahara	18,10
	327 23 13 090	LPS Design Adaptation section - for covering thicknesses 3,5 - 8,5 mm.	34 mm	90 cm SB	sahara	16,55
	327 23 11 270	LPS Design Adaptation section - for covering thicknesses 3,5 - 8,5 mm.	34 mm	270 cm SB	silver	46,20
	327 13 11 100	LPS Design Adaptation section - for covering thicknesses 3,5 - 8,5 mm.	34 mm	100 cm SB	silver	18,10
	327 23 11 090	LPS Design Adaptation section - for covering thicknesses 3,5 - 8,5 mm.	34 mm	90 cm SB	silver	16,55
	327 23 14 270	LPS Design Adaptation section - for covering thicknesses 3,5 - 8,5 mm.	34 mm	270 cm SB	stainless steel matt	48,35
	327 13 14 100	LPS Design Adaptation section - for covering thicknesses 3,5 - 8,5 mm.	34 mm	100 cm SB	stainless steel matt	18,85
	327 23 14 090	LPS Design Adaptation section - for covering thicknesses 3,5 - 8,5 mm.	34 mm	90 cm SB	stainless steel matt	17,20
	327 23 09 270	LPS Design Adaptation section - for covering thicknesses 3,5 - 8,5 mm.	34 mm	270 cm SB	stainless steel polished	57,55
	327 13 09 100	LPS Design Adaptation section - for covering thicknesses 3,5 - 8,5 mm.	34 mm	100 cm SB	stainless steel polished	23,05
	327 23 09 090	LPS Design Adaptation section - for covering thicknesses 3,5 - 8,5 mm.	34 mm	90 cm SB	stainless steel polished	20,55
	327 23 19 270	LPS Design Adaptation section - for covering thicknesses 3,5 - 8,5 mm.	34 mm	270 cm SB	stainless steel brushed	57,55
	327 13 19 100	LPS Design Adaptation section - for covering thicknesses 3,5 - 8,5 mm.	34 mm	100 cm SB	stainless steel brushed	23,05
	327 23 19 090	LPS Design Adaptation section - for covering thicknesses 3,5 - 8,5 mm.	34 mm	90 cm SB	stainless steel brushed	20,55

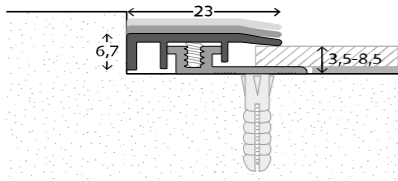
	328 23 13 270	LPS Design Edge section - for covering thicknesses 3,5 - 8,5 mm.	23 mm	270 cm SB	sahara	41,75
	328 13 13 100	LPS Design Edge section - for covering thicknesses 3,5 - 8,5 mm.	23 mm	100 cm SB	sahara	16,55
	328 23 13 090	LPS Design Edge section - for covering thicknesses 3,5 - 8,5 mm.	23 mm	90 cm SB	sahara	15,05
	328 23 11 270	LPS Design Edge section - for covering thicknesses 3,5 - 8,5 mm.	23 mm	270 cm SB	silver	41,75
	328 13 11 100	LPS Design Edge section - for covering thicknesses 3,5 - 8,5 mm.	23 mm	100 cm SB	silver	16,55
	328 23 11 090	LPS Design Edge section - for covering thicknesses 3,5 - 8,5 mm.	23 mm	90 cm SB	silver	15,05
	328 23 14 270	LPS Design Edge section - for covering thicknesses 3,5 - 8,5 mm.	23 mm	270 cm SB	stainless steel matt	43,20
	328 13 14 100	LPS Design Edge section - for covering thicknesses 3,5 - 8,5 mm.	23 mm	100 cm SB	stainless steel matt	17,15
	328 23 14 090	LPS Design Edge section - for covering thicknesses 3,5 - 8,5 mm.	23 mm	90 cm SB	stainless steel matt	15,60
	328 23 09 270	LPS Design Edge section - for covering thicknesses 3,5 - 8,5 mm.	23 mm	270 cm SB	stainless steel polished	52,65
	328 13 09 100	LPS Design Edge section - for covering thicknesses 3,5 - 8,5 mm.	23 mm	100 cm SB	stainless steel polished	20,85
	328 23 09 090	LPS Design Edge section - for covering thicknesses 3,5 - 8,5 mm.	23 mm	90 cm SB	stainless steel polished	19,05
	328 23 19 270	LPS Design Edge section - for covering thicknesses 3,5 - 8,5 mm.	23 mm	270 cm SB	stainless steel brushed	52,65
	328 13 19 100	LPS Design Edge section - for covering thicknesses 3,5 - 8,5 mm.	23 mm	100 cm SB	stainless steel brushed	20,85
	328 23 19 090	LPS Design Edge section - for covering thicknesses 3,5 - 8,5 mm.	23 mm	90 cm SB	stainless steel brushed	19,05

LPS Design Base sections with wide screwing blade						
	334 23 06 270	LPS Design base section with wide screwing blade - with screw holes	5,2 x 46 mm	270 cm	plate finish	25,25

Schets	Artikelnummer	Omschrijving	Afmeting	Lengte	Kleur	Bruto verkoopprijs / st.
--------	---------------	--------------	----------	--------	-------	--------------------------

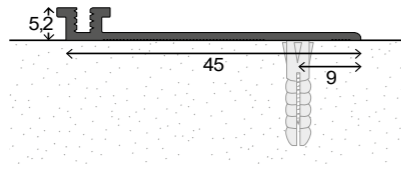

Prinz Profi-Design System



- > Clip profile system with aluminium top section and PVC base section.
- > Suitable for design floorings (Vinyl) with thicknesses from 4 up to 7,5 mm.
- > Continuously variable adaptation of both height and inclination.
- > Simple, fast and reliable installation - trouble-free disassembly and reusability.
- > Base and upper section are shrink-wrapped together.
- > We recommend gluing the base profile. No fixing material for the base profile enclosed.
- > DBGM (Deutsches Bundesgebrauchsmuster) 20 2012 102 304.

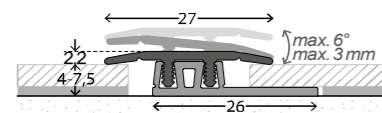

322 20 13 270	Profi-Design Connection section - for covering thicknesses 4,0 - 7,5 mm.	27 mm	270 cm	SB	sahara	35,00
322 10 13 100	Profi-Design Connection section - for covering thicknesses 4,0 - 7,5 mm.	27 mm	100 cm	SB	sahara	13,60
322 20 13 090	Profi-Design Connection section - for covering thicknesses 4,0 - 7,5 mm.	27 mm	90 cm	SB	sahara	12,30
322 20 11 270	Profi-Design Connection section - for covering thicknesses 4,0 - 7,5 mm.	27 mm	270 cm	SB	silver	35,00
322 10 11 100	Profi-Design Connection section - for covering thicknesses 4,0 - 7,5 mm.	27 mm	100 cm	SB	silver	13,60
322 20 11 090	Profi-Design Connection section - for covering thicknesses 4,0 - 7,5 mm.	27 mm	90 cm	SB	silver	12,30
322 20 14 270	Profi-Design Connection section - for covering thicknesses 4,0 - 7,5 mm.	27 mm	270 cm	SB	stainless steel matt	37,15
322 10 14 100	Profi-Design Connection section - for covering thicknesses 4,0 - 7,5 mm.	27 mm	100 cm	SB	stainless steel matt	14,30
322 20 14 090	Profi-Design Connection section - for covering thicknesses 4,0 - 7,5 mm.	27 mm	90 cm	SB	stainless steel matt	13,05
322 20 09 270	Profi-Design Connection section - for covering thicknesses 4,0 - 7,5 mm.	27 mm	270 cm	SB	stainless steel polished	44,85
322 10 09 100	Profi-Design Connection section - for covering thicknesses 4,0 - 7,5 mm.	27 mm	100 cm	SB	stainless steel polished	17,45
322 20 09 090	Profi-Design Connection section - for covering thicknesses 4,0 - 7,5 mm.	27 mm	90 cm	SB	stainless steel polished	15,80
322 20 19 270	Profi-Design Connection section - for covering thicknesses 4,0 - 7,5 mm.	27 mm	270 cm	SB	stainless steel brushed	44,85
322 10 19 100	Profi-Design Connection section - for covering thicknesses 4,0 - 7,5 mm.	27 mm	100 cm	SB	stainless steel brushed	17,45
322 20 19 090	Profi-Design Connection section - for covering thicknesses 4,0 - 7,5 mm.	27 mm	90 cm	SB	stainless steel brushed	15,80
322 20 17 270	Profi-Design Connection section - for covering thicknesses 4,0 - 7,5 mm.	27 mm	270 cm	SB	black anodised	44,85
322 10 17 100	Profi-Design Connection section - for covering thicknesses 4,0 - 7,5 mm.	27 mm	100 cm	SB	black anodised	17,45
322 20 17 090	Profi-Design Connection section - for covering thicknesses 4,0 - 7,5 mm.	27 mm	90 cm	SB	black anodised	15,80

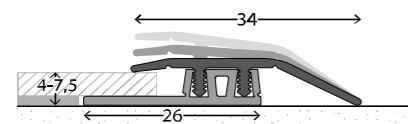

323 20 13 270	Profi-Design Adaptation section - for covering thicknesses 4,0 - 7,5 mm.	34 mm	270 cm	SB	sahara	37,30
323 10 13 100	Profi-Design Adaptation section - for covering thicknesses 4,0 - 7,5 mm.	34 mm	100 cm	SB	sahara	14,45
323 20 13 090	Profi-Design Adaptation section - for covering thicknesses 4,0 - 7,5 mm.	34 mm	90 cm	SB	sahara	13,25
323 20 11 270	Profi-Design Adaptation section - for covering thicknesses 4,0 - 7,5 mm.	34 mm	270 cm	SB	silver	37,30
323 10 11 100	Profi-Design Adaptation section - for covering thicknesses 4,0 - 7,5 mm.	34 mm	100 cm	SB	silver	14,45
323 20 11 090	Profi-Design Adaptation section - for covering thicknesses 4,0 - 7,5 mm.	34 mm	90 cm	SB	silver	13,25
323 20 14 270	Profi-Design Adaptation section - for covering thicknesses 4,0 - 7,5 mm.	34 mm	270 cm	SB	stainless steel matt	39,45
323 10 14 100	Profi-Design Adaptation section - for covering thicknesses 4,0 - 7,5 mm.	34 mm	100 cm	SB	stainless steel matt	15,15
323 20 14 090	Profi-Design Adaptation section - for covering thicknesses 4,0 - 7,5 mm.	34 mm	90 cm	SB	stainless steel matt	13,75
323 20 09 270	Profi-Design Adaptation section - for covering thicknesses 4,0 - 7,5 mm.	34 mm	270 cm	SB	stainless steel polished	48,50
323 10 09 100	Profi-Design Adaptation section - for covering thicknesses 4,0 - 7,5 mm.	34 mm	100 cm	SB	stainless steel polished	19,70
323 20 09 090	Profi-Design Adaptation section - for covering thicknesses 4,0 - 7,5 mm.	34 mm	90 cm	SB	stainless steel polished	17,60
323 20 19 270	Profi-Design Adaptation section - for covering thicknesses 4,0 - 7,5 mm.	34 mm	270 cm	SB	stainless steel brushed	48,50
323 10 19 100	Profi-Design Adaptation section - for covering thicknesses 4,0 - 7,5 mm.	34 mm	100 cm	SB	stainless steel brushed	19,70
323 20 19 090	Profi-Design Adaptation section - for covering thicknesses 4,0 - 7,5 mm.	34 mm	90 cm	SB	stainless steel brushed	17,60
323 20 17 270	Profi-Design Adaptation section - for covering thicknesses 4,0 - 7,5 mm.	34 mm	270 cm	SB	black anodised	48,50
323 10 17 100	Profi-Design Adaptation section - for covering thicknesses 4,0 - 7,5 mm.	34 mm	100 cm	SB	black anodised	19,70

Schets	Artikelnummer	Omschrijving	Afmeting	Lengte	Kleur	Bruto verkoopprijs / st.
	323 20 17 090	Profi-Design Adaptation section - for covering thicknesses 4,0 - 7,5 mm.	34 mm	90 cm SB	black anodised	17,60
	324 20 13 270	Profi-Design Edge section - for covering thicknesses 4,0 - 7,5 mm.	21 mm	270 cm SB	sahara	35,00
	324 10 13 100	Profi-Design Edge section - for covering thicknesses 4,0 - 7,5 mm.	21 mm	100 cm SB	sahara	13,60
	324 20 13 090	Profi-Design Edge section - for covering thicknesses 4,0 - 7,5 mm.	21 mm	90 cm SB	sahara	12,30
	324 20 11 270	Profi-Design Edge section - for covering thicknesses 4,0 - 7,5 mm.	21 mm	270 cm SB	silver	35,00
	324 10 11 100	Profi-Design Edge section - for covering thicknesses 4,0 - 7,5 mm.	21 mm	100 cm SB	silver	13,60
	324 20 11 090	Profi-Design Edge section - for covering thicknesses 4,0 - 7,5 mm.	21 mm	90 cm SB	silver	12,30
	324 20 14 270	Profi-Design Edge section - for covering thicknesses 4,0 - 7,5 mm.	21 mm	270 cm SB	stainless steel matt	37,15
	324 10 14 100	Profi-Design Edge section - for covering thicknesses 4,0 - 7,5 mm.	21 mm	100 cm SB	stainless steel matt	14,30
	324 20 14 090	Profi-Design Edge section - for covering thicknesses 4,0 - 7,5 mm.	21 mm	90 cm SB	stainless steel matt	13,05
	324 20 09 270	Profi-Design Edge section - for covering thicknesses 4,0 - 7,5 mm.	21 mm	270 cm SB	stainless steel polished	44,85
	324 10 09 100	Profi-Design Edge section - for covering thicknesses 4,0 - 7,5 mm.	21 mm	100 cm SB	stainless steel polished	17,45
	324 20 09 090	Profi-Design Edge section - for covering thicknesses 4,0 - 7,5 mm.	21 mm	90 cm SB	stainless steel polished	15,80
	324 20 19 270	Profi-Design Edge section - for covering thicknesses 4,0 - 7,5 mm.	21 mm	270 cm SB	stainless steel brushed	44,85
	324 10 19 100	Profi-Design Edge section - for covering thicknesses 4,0 - 7,5 mm.	21 mm	100 cm SB	stainless steel brushed	17,45
	324 20 19 090	Profi-Design Edge section - for covering thicknesses 4,0 - 7,5 mm.	21 mm	90 cm SB	stainless steel brushed	15,80
		324 20 17 270	Profi-Design Edge section - for covering thicknesses 4,0 - 7,5 mm.	21 mm	270 cm SB	black anodised
	324 10 17 100	Profi-Design Edge section - for covering thicknesses 4,0 - 7,5 mm.	21 mm	100 cm SB	black eloxiert	17,45
	324 20 17 090	Profi-Design Edge section - for covering thicknesses 4,0 - 7,5 mm.	21 mm	90 cm SB	black anodised	15,80

> for Rigid Core flooring with laminated impact sound insulation

338 10 11 200	Profi Design CORE Connection section - for covering thicknesses 5 - 7,5 mm.	27 mm	200 cm SB	silver	27,10
338 10 14 200	Profi Design CORE Connection section - for covering thicknesses 5 - 7,5 mm.	34 mm	200 cm SB	stainless steel matt	28,80
338 10 17 200	Profi Design CORE Connection section - for covering thicknesses 5 - 7,5 mm.	27 mm	200 cm SB	black anodised	34,80
338 10 19 200	Profi Design CORE Connection section - for covering thicknesses 5 - 7,5 mm.	27 mm	200 cm SB	stainless steel brushed	34,80

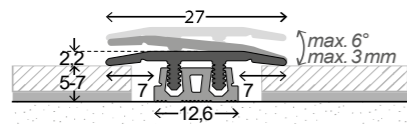

339 10 11 200	Profi Design CORE Adaptation section - for covering thicknesses 5 - 7,5 mm.	34 mm	200 cm SB	silver	29,10
339 10 14 200	Profi Design CORE Adaptation section - for covering thicknesses 5 - 7,5 mm.	34 mm	200 cm SB	stainless steel matt	30,60
339 10 17 200	Profi Design CORE Adaptation section - for covering thicknesses 5 - 7,5 mm.	34 mm	200 cm SB	black anodised	37,70
339 10 19 200	Profi Design CORE Adaptation section - for covering thicknesses 5 - 7,5 mm.	34 mm	200 cm SB	stainless steel brushed	37,70

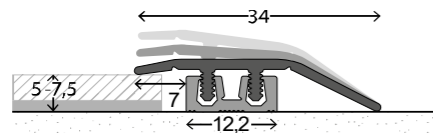

333 10 11 200	Profi Design CORE Edge section - for covering thicknesses 5 - 7,5 mm.	21 mm	200 cm SB	silver	27,10
333 10 14 200	Profi Design CORE Edge section - for covering thicknesses 5 - 7,5 mm.	21 mm	200 cm SB	stainless steel matt	28,80
333 10 17 200	Profi Design CORE Edge section - for covering thicknesses 5 - 7,5 mm.	21 mm	200 cm SB	black anodised	34,80
333 10 19 200	Profi Design CORE Edge section - for covering thicknesses 5 - 7,5 mm.	21 mm	200 cm SB	stainless steel brushed	34,80

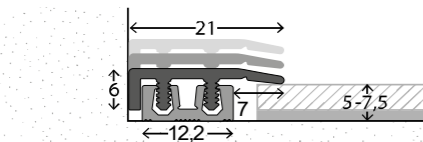

Design Step stair nosing system

- > Stair nosing system for renovating stairs with design coverings.
- > Upper and base section made of aluminium.
- > Suitable for covering thicknesses of 4.0 - 6.5 mm.
- > Upper and base section packed together incl. fixing material.



Schets	Artikelnummer	Omschrijving	Afmeting	Lengte	Kleur	Bruto verkoopprijs / st.
--------	---------------	--------------	----------	--------	-------	--------------------------

> The system is offered in two versions: a) as a screw system (type 331), b) as a clip system with concealed fastening (type 330).
 > DBGM 20 2019 100 158

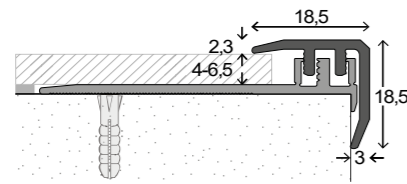

Design Step clip system type 330 - upper profiles are snapped into the base profile, without visible fixing.						
330 10 11 250	DESIGN-STEP Clip section - for covering thicknesses 4,0 - 6,5 mm.	18,5 x 18,5 mm	250 cm	SB	silver	55,50
330 10 11 100	DESIGN-STEP Clip section - for covering thicknesses 4,0 - 6,5 mm.	18,5 x 18,5 mm	100 cm	SB	silver	22,20
330 10 14 250	DESIGN-STEP Clip section - for covering thicknesses 4,0 - 6,5 mm.	18,5 x 18,5 mm	250 cm	SB	stainless steel matt	58,50
330 10 14 100	DESIGN-STEP Clip section - for covering thicknesses 4,0 - 6,5 mm.	18,5 x 18,5 mm	100 cm	SB	stainless steel matt	23,40
330 10 19 250	DESIGN-STEP Clip section - for covering thicknesses 4,0 - 6,5 mm.	18,5 x 18,5 mm	250 cm	SB	stainless steel brushed	61,65
330 10 19 100	DESIGN-STEP Clip section - for covering thicknesses 4,0 - 6,5 mm.	18,5 x 18,5 mm	100 cm	SB	stainless steel brushed	24,65

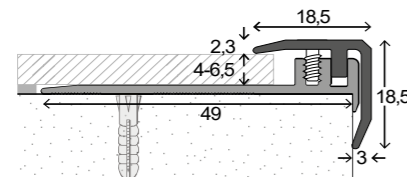

Design Step screw system type 331 - upper profiles are perforated and screwed into the base profile.						
331 13 11 250	DESIGN-STEP Screw section - for covering thicknesses 4,0 - 6,5 mm.	18,5 x 18,5 mm	250 cm	SB	silver	60,65
331 13 11 100	DESIGN-STEP Screw section - for covering thicknesses 4,0 - 6,5 mm.	18,5 x 18,5 mm	100 cm	SB	silver	24,25
331 13 14 250	DESIGN-STEP Screw section - for covering thicknesses 4,0 - 6,5 mm.	18,5 x 18,5 mm	250 cm	SB	stainless steel matt	63,15
331 13 14 100	DESIGN-STEP Screw section - for covering thicknesses 4,0 - 6,5 mm.	18,5 x 18,5 mm	100 cm	SB	stainless steel matt	25,25
331 13 19 250	DESIGN-STEP Screw section - for covering thicknesses 4,0 - 6,5 mm.	18,5 x 18,5 mm	250 cm	SB	stainless steel brushed	67,25
331 13 19 100	DESIGN-STEP Screw section - for covering thicknesses 4,0 - 6,5 mm.	18,5 x 18,5 mm	100 cm	SB	stainless steel brushed	26,90

Prinz D.O.S. System



- > Anchoring system with aluminium section and nylon lamella anchors.
- > For floor coverings up to 17,5 mm.
- > Continuously variable adaptation of both HEIGHT and INCLINATION.
- > For subsequent installation.
- > Concealed fastening with nylon lamella anchors.
- > Shrink-wrapped incl. lamella anchors.

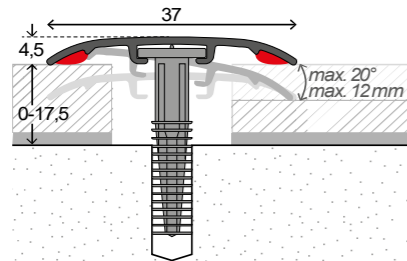

208 14 11 250	D.O.S. Universal section - for floor coverings 0 - 17,5 mm - auto-adhesive.	37 mm	250 cm	SB	silver	39,65
208 14 11 100	D.O.S. Universal section - for floor coverings 0 - 17,5 mm - auto-adhesive.	37 mm	100 cm	SB	silver	15,85
208 14 14 250	D.O.S. Universal section - for floor coverings 0 - 17,5 mm - auto-adhesive.	37 mm	250 cm	SB	stainless steel matt	46,00
208 14 14 100	D.O.S. Universal section - for floor coverings 0 - 17,5 mm - auto-adhesive.	37 mm	100 cm	SB	stainless steel matt	18,40

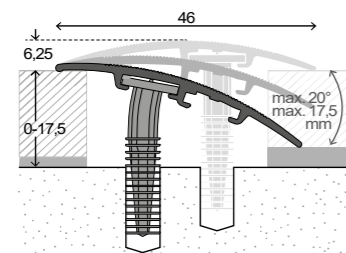

For covering thicknesses up to 17.5 mm. Suitable for equal-height coverings and for levelling out differences in le						
209 20 10 270	D.O.S. Universal section - for floor coverings 0 - 17,5 mm.	46 mm	270 cm	SB	gold	43,10
209 20 10 090	D.O.S. Universal section - for floor coverings 0 - 17,5 mm.	46 mm	90 cm	SB	gold	14,85
209 20 13 270	D.O.S. Universal section - for floor coverings 0 - 17,5 mm.	46 mm	270 cm	SB	sahara	43,10
209 20 13 090	D.O.S. Universal section - for floor coverings 0 - 17,5 mm.	46 mm	90 cm	SB	sahara	14,85
209 20 11 270	D.O.S. Universal section - for floor coverings 0 - 17,5 mm.	46 mm	270 cm	SB	silver	43,10
209 20 11 090	D.O.S. Universal section - for floor coverings 0 - 17,5 mm.	46 mm	90 cm	SB	silver	14,85
209 20 14 270	D.O.S. Universal section - for floor coverings 0 - 17,5 mm.	46 mm	270 cm	SB	stainless steel matt	45,50
209 20 14 090	D.O.S. Universal section - for floor coverings 0 - 17,5 mm.	46 mm	90 cm	SB	stainless steel matt	15,65

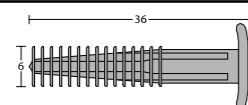

830 10 00 036	D.O.S. Nylon Lamella anchors - cartridge with 5 plugs (price per cartridge) - with suspens	36 mm	36 mm	SB		1,30
---------------	--	-------	-------	----	--	------

For covering thicknesses up to 17.5 mm. Suitable for equal-height coverings and for levelling out differences in le						
201 20 10 270	D.O.S. Connection section - for covering thicknesses 0 - 17,5 mm.	30 mm	270 cm	SB	gold	33,90
201 20 10 090	D.O.S. Connection section - for covering thicknesses 0 - 17,5 mm.	30 mm	90 cm	SB	gold	11,10

Schets	Artikelnummer	Omschrijving	Afmeting	Lengte	Kleur	Bruto verkoopprijs / st.		
	201 20 13 270	D.O.S. Connection section - for covering thicknesses 0 - 17,5 mm.	30 mm	270 cm SB	sahara	33,90		
	201 20 13 090	D.O.S. Connection section - for covering thicknesses 0 - 17,5 mm.	30 mm	90 cm SB	sahara	11,10		
	201 20 11 270	D.O.S. Connection section - for covering thicknesses 0 - 17,5 mm.	30 mm	270 cm SB	silver	33,90		
	201 20 11 090	D.O.S. Connection section - for covering thicknesses 0 - 17,5 mm.	30 mm	90 cm SB	silver	11,10		
	201 20 12 270	D.O.S. Connection section - for covering thicknesses 0 - 17,5 mm.	30 mm	270 cm SB	bronze	36,20		
	201 20 12 090	D.O.S. Connection section - for covering thicknesses 0 - 17,5 mm.	30 mm	90 cm SB	bronze	12,00		
	201 20 14 270	D.O.S. Connection section - for covering thicknesses 0 - 17,5 mm.	30 mm	270 cm SB	stainless steel matt	36,20		
	201 20 14 090	D.O.S. Connection section - for covering thicknesses 0 - 17,5 mm.	30 mm	90 cm SB	stainless steel matt	12,00		
	201 20 09 270	D.O.S. Connection section - for covering thicknesses 0 - 17,5 mm.	30 mm	270 cm SB	stainless steel polished	45,10		
	201 20 09 090	D.O.S. Connection section - for covering thicknesses 0 - 17,5 mm.	30 mm	90 cm SB	stainless steel polished	15,25		
	202 40 20 270	D.O.S. Connection section - for covering thicknesses 0 - 17,5 mm.	30 mm	270 cm SB	beech	40,50		
	202 40 20 090	D.O.S. Connection section - for covering thicknesses 0 - 17,5 mm.	30 mm	90 cm SB	beech	13,75		
	202 40 21 270	D.O.S. Connection section - for covering thicknesses 0 - 17,5 mm.	30 mm	270 cm SB	dark oak	40,50		
	202 40 21 090	D.O.S. Connection section - for covering thicknesses 0 - 17,5 mm.	30 mm	90 cm SB	dark oak	13,75		
	202 40 25 270	D.O.S. Connection section - for covering thicknesses 0 - 17,5 mm.	30 mm	270 cm SB	light oak	40,50		
	202 40 25 090	D.O.S. Connection section - for covering thicknesses 0 - 17,5 mm.	30 mm	90 cm SB	light oak	13,75		
	202 40 26 270	D.O.S. Connection section - for covering thicknesses 0 - 17,5 mm.	30 mm	270 cm SB	oak whitewashed	40,50		
	202 40 26 090	D.O.S. Connection section - for covering thicknesses 0 - 17,5 mm.	30 mm	90 cm SB	oak whitewashed	13,75		
	202 40 22 270	D.O.S. Connection section - for covering thicknesses 0 - 17,5 mm.	30 mm	270 cm SB	maple	40,50		
	202 40 22 090	D.O.S. Connection section - for covering thicknesses 0 - 17,5 mm.	30 mm	90 cm SB	maple	13,75		
	202 40 24 270	D.O.S. Connection section - for covering thicknesses 0 - 17,5 mm.	30 mm	270 cm SB	walnut	40,50		
	202 40 24 090	D.O.S. Connection section - for covering thicknesses 0 - 17,5 mm.	30 mm	90 cm SB	walnut	13,75		
	202 40 27 270	D.O.S. Connection section - for covering thicknesses 0 - 17,5 mm.	30 mm	270 cm SB	light grey oak	40,50		
	202 40 27 090	D.O.S. Connection section - for covering thicknesses 0 - 17,5 mm.	30 mm	90 cm SB	light grey oak	13,75		
	202 40 28 270	D.O.S. Connection section - for covering thicknesses 0 - 17,5 mm.	30 mm	270 cm SB	grey oak	40,50		
	202 40 28 090	D.O.S. Connection section - for covering thicknesses 0 - 17,5 mm.	30 mm	90 cm SB	grey oak	13,75		
		For covering thicknesses up to 4 - 17.5 mm. Continuously compensates for differences in height.						
		205 20 10 270	D.O.S. Adaptation section - for covering thicknesses 4 - 17,5 mm.	37 mm	270 cm SB	gold	40,80	
205 20 10 090		D.O.S. Adaptation section - for covering thicknesses 4 - 17,5 mm.	37 mm	90 cm SB	gold	13,55		
205 20 13 270		D.O.S. Adaptation section - for covering thicknesses 4 - 17,5 mm.	37 mm	270 cm SB	sahara	40,80		
205 20 13 090		D.O.S. Adaptation section - for covering thicknesses 4 - 17,5 mm.	37 mm	90 cm SB	sahara	13,55		
205 20 11 270		D.O.S. Adaptation section - for covering thicknesses 4 - 17,5 mm.	37 mm	270 cm SB	silver	40,80		
205 20 11 090		D.O.S. Adaptation section - for covering thicknesses 4 - 17,5 mm.	37 mm	90 cm SB	silver	13,55		
205 20 12 270		D.O.S. Adaptation section - for covering thicknesses 4 - 17,5 mm.	37 mm	270 cm SB	bronze	47,55		
205 20 12 090		D.O.S. Adaptation section - for covering thicknesses 4 - 17,5 mm.	37 mm	90 cm SB	bronze	15,90		
205 20 14 270		D.O.S. Adaptation section - for covering thicknesses 4 - 17,5 mm.	37 mm	270 cm SB	stainless steel matt	47,55		
205 20 14 090		D.O.S. Adaptation section - for covering thicknesses 4 - 17,5 mm.	37 mm	90 cm SB	stainless steel matt	15,90		
205 20 09 270		D.O.S. Adaptation section - for covering thicknesses 4 - 17,5 mm.	37 mm	270 cm SB	stainless steel polished	54,30		
205 20 09 090		D.O.S. Adaptation section - for covering thicknesses 4 - 17,5 mm.	37 mm	90 cm SB	stainless steel polished	18,40		
206 40 20 270		D.O.S. Adaptation section - for covering thicknesses 4 - 17,5 mm.	37 mm	270 cm SB	beech	44,45		
206 40 20 090		D.O.S. Adaptation section - for covering thicknesses 4 - 17,5 mm.	37 mm	90 cm SB	beech	14,90		
206 40 21 270		D.O.S. Adaptation section - for covering thicknesses 4 - 17,5 mm.	37 mm	270 cm SB	dark oak	44,45		
206 40 21 090		D.O.S. Adaptation section - for covering thicknesses 4 - 17,5 mm.	37 mm	90 cm SB	dark oak	14,90		
206 40 25 270		D.O.S. Adaptation section - for covering thicknesses 4 - 17,5 mm.	37 mm	270 cm SB	light oak	44,45		
206 40 25 090	D.O.S. Adaptation section - for covering thicknesses 4 - 17,5 mm.	37 mm	90 cm SB	light oak	14,90			
206 40 26 270	D.O.S. Adaptation section - for covering thicknesses 4 - 17,5 mm.	37 mm	270 cm SB	oak whitewashed	44,45			
206 40 26 090	D.O.S. Adaptation section - for covering thicknesses 4 - 17,5 mm.	37 mm	90 cm SB	oak whitewashed	14,90			
206 40 22 270	D.O.S. Adaptation section - for covering thicknesses 4 - 17,5 mm.	37 mm	270 cm SB	maple	44,45			
206 40 22 090	D.O.S. Adaptation section - for covering thicknesses 4 - 17,5 mm.	37 mm	90 cm SB	maple	14,90			

Schets	Artikelnummer	Omschrijving	Afmeting	Lengte	Kleur	Bruto verkoopprijs / st.
	206 40 24 270	D.O.S. Adaptation section - for covering thicknesses 4 - 17,5 mm.	37 mm	270 cm SB	walnut	44,45
	206 40 24 090	D.O.S. Adaptation section - for covering thicknesses 4 - 17,5 mm.	37 mm	90 cm SB	walnut	14,90
	206 40 27 270	D.O.S. Adaptation section - for covering thicknesses 4 - 17,5 mm.	37 mm	270 cm SB	light grey oak	44,45
	206 40 27 090	D.O.S. Adaptation section - for covering thicknesses 4 - 17,5 mm.	37 mm	90 cm SB	light grey oak	14,90
	206 40 28 270	D.O.S. Adaptation section - for covering thicknesses 4 - 17,5 mm.	37 mm	270 cm SB	grey oak	44,45
	206 40 28 090	D.O.S. Adaptation section - for covering thicknesses 4 - 17,5 mm.	37 mm	90 cm SB	grey oak	14,90

Connection Sections

	120 01 01 270	Connection section steel, brass coated - centre countersunk holes	30 mm	270 cm S		11,25
	120 01 01 100	Connection section steel, brass coated - centre countersunk holes	30 mm	100 cm SB		6,20
	120 04 01 100	Connection section steel, brass coated - auto-adhesive	30 mm	100 cm SB		7,60
	122 01 01 270	Connection section steel, brass coated - centre countersunk holes	40 mm	270 cm S		14,60
	122 01 01 100	Connection section steel, brass coated - centre countersunk holes	40 mm	100 cm SB		7,50
	124 01 01 270	Brass Connection section - centre countersunk holes	30 x 1,0 mm	270 cm S		28,80
	124 01 01 100	Brass Connection section - centre countersunk holes	30 x 1,0 mm	100 cm SB		12,95
	124 04 01 100	Brass Connection section - auto-adhesive	30 x 1,0 mm	100 cm SB		14,20
	125 01 01 270	Brass Connection section - centre countersunk holes	30 x 1,2 mm	270 cm S		33,90
	125 01 01 100	Brass Connection section - centre countersunk holes	30 x 1,2 mm	100 cm SB		15,10
	125 04 01 270	Brass Connection section - auto-adhesive	30 x 1,2 mm	270 cm S		43,10
	125 04 01 100	Brass Connection section - auto-adhesive	30 x 1,2 mm	100 cm SB		16,30
	126 01 01 270	Brass Connection section - centre countersunk holes	40 mm	270 cm S		45,00
	126 01 01 100	Brass Connection section - centre countersunk holes	40 mm	100 cm SB		19,20

Schets	Artikelnummer	Omschrijving	Afmeting	Lengte	Kleur	Bruto verkoopprijs / st.
	126 02 01 270	Brass Connection section - lateral countersunk holes	40 mm	270 cm S		45,00
	126 02 01 100	Brass Connection section - lateral countersunk holes	40 mm	100 cm SB		19,20
	127 11 03 500	Brass Connection section - centre countersunk holes	50 mm	500 cm S	brass polished	Op aanvraag
	127 12 03 500	Brass Connection section - lateral countersunk holes	50 mm	500 cm S	brass polished	Op aanvraag
	128 11 03 500	Brass Connection section - centre countersunk holes	60 mm	500 cm S	brass polished	Op aanvraag
	128 12 03 500	Brass Connection section - lateral countersunk holes	60 mm	500 cm S	brass polished	Op aanvraag
	110 01 01 500	Stainless steel Connection section - with mirror finish - centre countersunk holes	30 mm	500 cm S	stainless steel mirror finished	Op aanvraag
	110 01 01 270	Stainless steel Connection section - with mirror finish - centre countersunk holes	30 mm	270 cm S	stainless steel mirror finished	11,35
	110 01 01 100	Stainless steel Connection section - with mirror finish - centre countersunk holes	30 mm	100 cm SB	stainless steel mirror finished	5,95
	110 04 01 270	Stainless steel Connection section - with mirror finish - auto-adhesive	30 mm	270 cm S	stainless steel mirror finished	18,25
	110 04 01 100	Stainless steel Connection section - with mirror finish - auto-adhesive	30 mm	100 cm SB	stainless steel mirror finished	7,35
	111 01 01 270	Stainless steel Connection section - with mirror finish - centre countersunk holes	40 mm	270 cm S	stainless steel mirror finished	14,60

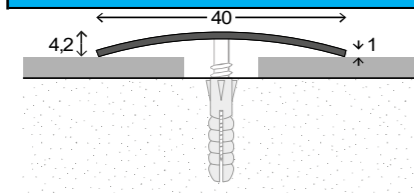
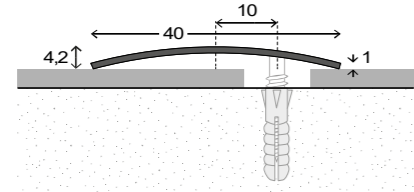
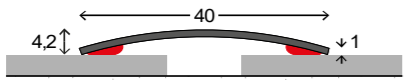
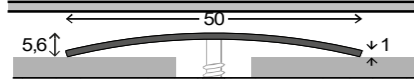
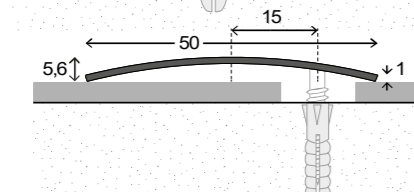
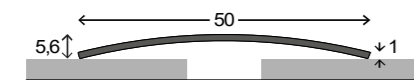
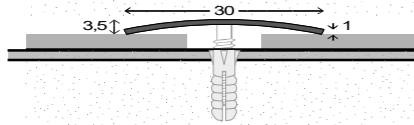
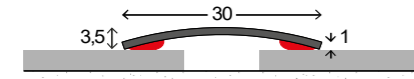
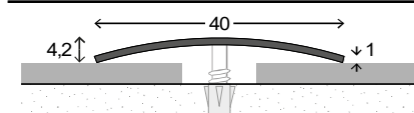
Schets	Artikelnummer	Omschrijving	Afmeting	Lengte	Kleur	Bruto verkoopprijs / st.
	111 01 01 100	Stainless steel Connection section - with mirror finish - centre countersunk holes	40 mm	100 cm SB	stainless steel mirror finished	6,85
	111 02 01 500	Stainless steel Connection section - with mirror finish - lateral countersunk holes	40 mm	500 cm S	stainless steel mirror finished	Op aanvraag
	111 02 01 270	Stainless steel Connection section - with mirror finish - lateral countersunk holes	40 mm	270 cm S	stainless steel mirror finished	14,60
	111 02 01 100	Stainless steel Connection section - with mirror finish - lateral countersunk holes	40 mm	100 cm SB	stainless steel mirror finished	6,85
	111 04 01 270	Stainless steel Connection section - with mirror finish - auto-adhesive	40 mm	270 cm S	stainless steel mirror finished	20,40
	111 04 01 100	Stainless steel Connection section - with mirror finish - auto-adhesive	40 mm	100 cm SB	stainless steel mirror finished	8,25
	102 01 01 270	Stainless steel Connection section - with mirror finish - centre countersunk holes	50 mm	270 cm S	stainless steel mirror finished	20,70
	102 02 01 270	Stainless steel Connection section - with mirror finish - lateral countersunk holes	50 mm	270 cm S	stainless steel mirror finished	20,70
	102 00 01 270	Stainless steel Connection section - with mirror finish - without screw holes	50 mm	270 cm S	stainless steel mirror finished	20,70
	112 01 04 500	Stainless steel Connection section - brushed surface - centre countersunk holes	30 mm	500 cm S	stainless steel brushed	Op aanvraag
	112 01 04 270	Stainless steel Connection section - brushed surface - centre countersunk holes	30 mm	270 cm S	stainless steel brushed	13,95
	112 01 04 270 SB	Stainless steel Connection section - brushed surface - centre countersunk holes - incl. fix	30 mm	270 cm SB	stainless steel brushed	16,65
	112 01 04 100	Stainless steel Connection section - brushed surface - centre countersunk holes	30 mm	100 cm SB	stainless steel brushed	6,55
	112 04 04 270	Stainless steel Connection section - brushed surface - auto-adhesive	30 mm	270 cm S	stainless steel brushed	19,05
	112 04 04 100	Stainless steel Connection section - brushed surface - auto-adhesive	30 mm	100 cm SB	stainless steel brushed	7,80
	112 04 04 090	Stainless steel Connection section - brushed surface - auto-adhesive	30 mm	90 cm SB	stainless steel brushed	7,10
	113 01 04 500	Stainless steel Connection section - brushed surface - centre countersunk holes	40 mm	500 cm S	stainless steel brushed	Op aanvraag
	113 01 04 270	Stainless steel Connection section - brushed surface - centre countersunk holes	40 mm	270 cm S	stainless steel brushed	16,75
	113 01 04 100	Stainless steel Connection section - brushed surface - centre countersunk holes	40 mm	100 cm SB	stainless steel brushed	7,70

Schets	Artikelnummer	Omschrijving	Afmeting	Lengte	Kleur	Bruto verkoopprijs / st.
	113 02 04 500	Stainless steel Connection section - brushed surface - lateral countersunk holes	40 mm	500 cm S	stainless steel brushed	Op aanvraag
	113 02 04 270	Stainless steel Connection section - brushed surface - lateral countersunk holes	40 mm	270 cm S	stainless steel brushed	16,75
	113 02 04 270 SB	Stainless steel Connection section - brushed surface - lateral countersunk holes - incl. fix	40 mm	270 cm SB	stainless steel brushed	19,60
	113 02 04 100	Stainless steel Connection section - brushed surface - lateral countersunk holes	40 mm	100 cm SB	stainless steel brushed	7,70
	113 00 04 500	Stainless steel Connection section - brushed surface - without screw holes	40 mm	500 cm S	stainless steel brushed	Op aanvraag
	113 00 04 270	Stainless steel Connection section - brushed surface - without screw holes	40 mm	270 cm S	stainless steel brushed	16,75
	113 04 04 270	Stainless steel Connection section - brushed surface - auto-adhesive	40 mm	270 cm S	stainless steel brushed	23,10
	113 04 04 100	Stainless steel Connection section - brushed surface - auto-adhesive	40 mm	100 cm SB	stainless steel brushed	9,05
	101 01 04 500	Stainless steel Connection section - brushed surface - centre countersunk holes	50 mm	500 cm S	stainless steel brushed	Op aanvraag
	101 01 04 270	Stainless steel Connection section - brushed surface - centre countersunk holes	50 mm	270 cm S	stainless steel brushed	23,10
	101 02 04 500	Stainless steel Connection section - brushed surface - lateral countersunk holes	50 mm	500 cm S	stainless steel brushed	Op aanvraag
	101 02 04 270	Stainless steel Connection section - brushed surface - lateral countersunk holes	50 mm	270 cm S	stainless steel brushed	23,10
	101 00 04 270	Stainless steel Connection section - brushed surface - without screw holes	50 mm	270 cm S	stainless steel brushed	23,10
	104 10 04 250	Stainless steel Flat section - brushed surface - without screw holes	40 x 2 mm	250 cm	stainless steel brushed	41,90
	104 10 04 100	Stainless steel Flat section - brushed surface - without screw holes	40 x 2 mm	100 cm	stainless steel brushed	24,05
	104 11 04 250	Stainless steel Flat section - brushed surface - with screw holes	40 x 2 mm	250 cm	stainless steel brushed	46,65
	104 11 04 100	Stainless steel Flat section - brushed surface - with screw holes	40 x 2 mm	100 cm	stainless steel brushed	26,45
	105 10 04 250	Stainless steel Flat section - brushed surface - without screw holes	50 x 2 mm	250 cm	stainless steel brushed	48,50
	105 10 04 100	Stainless steel Flat section - brushed surface - without screw holes	50 x 2 mm	100 cm	stainless steel brushed	26,40

Schets	Artikelnummer	Omschrijving	Afmeting	Lengte	Kleur	Bruto verkoopprijs / st.
--------	---------------	--------------	----------	--------	-------	--------------------------

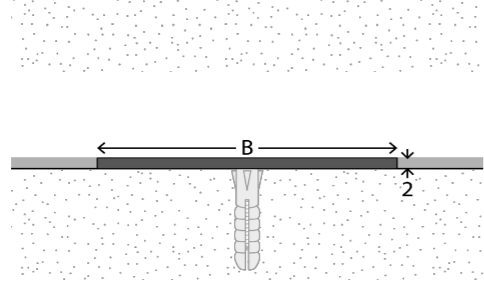

105 11 04 250	Stainless steel Flat section - brushed surface - with screw holes	50 x 2 mm	250 cm	stainless steel brushed	53,25
105 11 04 100	Stainless steel Flat section - brushed surface - with screw holes	50 x 2 mm	100 cm	stainless steel brushed	28,75

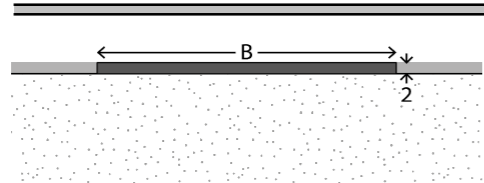

109 10 04 250	Stainless steel Flat section - brushed surface - without screw holes	60 x 2 mm	250 cm	stainless steel brushed	56,75
109 10 04 100	Stainless steel Flat section - brushed surface - without screw holes	60 x 2 mm	100 cm	stainless steel brushed	29,65

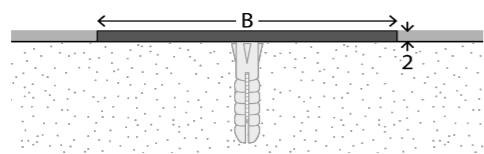

109 11 04 250	Stainless steel Flat section - brushed surface - with screw holes	60 x 2 mm	250 cm	stainless steel brushed	61,40
109 11 04 100	Stainless steel Flat section - brushed surface - with screw holes	60 x 2 mm	100 cm	stainless steel brushed	31,90

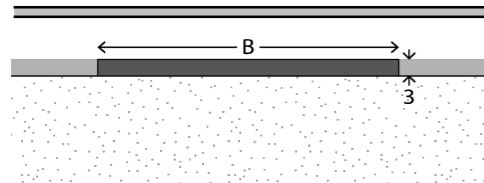

116 10 04 250	Stainless steel Flat section - brushed surface - without screw holes	40 x 3 mm	250 cm	stainless steel brushed	57,75
116 10 04 100	Stainless steel Flat section - brushed surface - without screw holes	40 x 3 mm	100 cm	stainless steel brushed	31,55

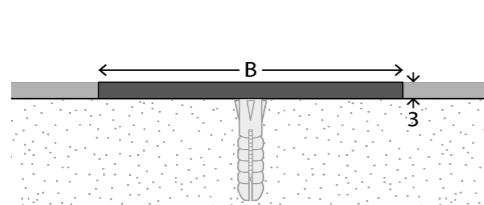

116 11 04 250	Stainless steel Flat section - brushed surface - with screw holes	40 x 3 mm	250 cm	stainless steel brushed	62,75
116 11 04 100	Stainless steel Flat section - brushed surface - with screw holes	40 x 3 mm	100 cm	stainless steel brushed	33,90

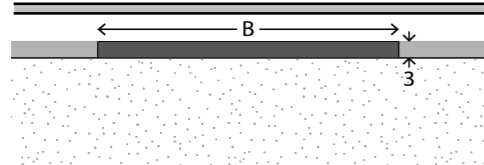

123 10 04 250	Stainless steel Flat section - brushed surface - without screw holes	50 x 3 mm	250 cm	stainless steel brushed	67,65
123 10 04 100	Stainless steel Flat section - brushed surface - without screw holes	50 x 3 mm	100 cm	stainless steel brushed	35,10

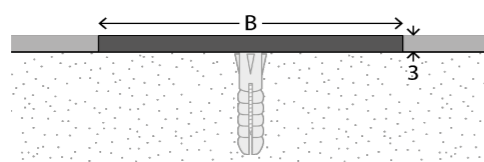

123 11 04 250	Stainless steel Flat section - brushed surface - with screw holes	50 x 3 mm	250 cm	stainless steel brushed	72,65
123 11 04 100	Stainless steel Flat section - brushed surface - with screw holes	50 x 3 mm	100 cm	stainless steel brushed	37,55

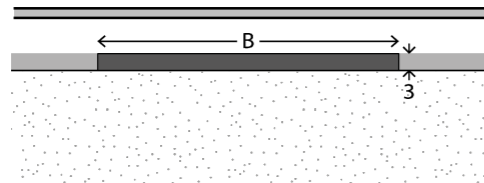

129 10 04 250	Stainless steel Flat section - brushed surface - without screw holes	60 x 3 mm	250 cm	stainless steel brushed	80,15
129 10 04 100	Stainless steel Flat section - brushed surface - without screw holes	60 x 3 mm	100 cm	stainless steel brushed	40,00

← B →

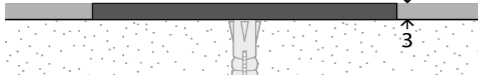
Schets	Artikelnummer	Omschrijving	Afmeting	Lengte	Kleur	Bruto verkoopprijs / st.
	129 11 04 250	Stainless steel Flat section - brushed surface - with screw holes	60 x 3 mm	250 cm	stainless steel brushed	85,15
	129 11 04 100	Stainless steel Flat section - brushed surface - with screw holes	60 x 3 mm	100 cm	stainless steel brushed	42,40

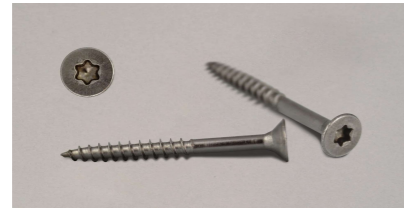

832 40 00 025	Bag with 100 TORX-screws	3,0 x 35 mm		stainless steel	9,05
---------------	--------------------------	-------------	--	-----------------	-------------

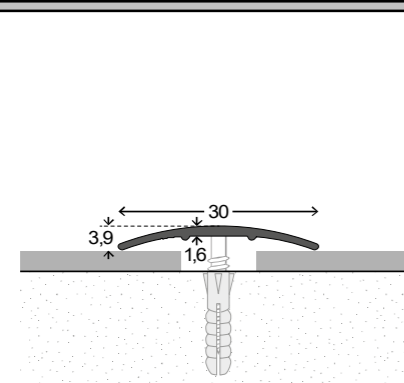

130 21 10 270	Aluminium Connection section - centre countersunk holes	30 mm	270 cm	gold	13,40
130 21 10 270 SB	Aluminium Connection section - centre countersunk holes - incl. screws and plugs	30 mm	270 cm SB	gold	16,20
130 11 10 100	Aluminium Connection section - centre countersunk holes	30 mm	100 cm SB	gold	6,00
130 21 10 090	Aluminium Connection section - centre countersunk holes	30 mm	90 cm SB	gold	5,60
130 21 13 270	Aluminium Connection section - centre countersunk holes	30 mm	270 cm	sahara	13,40
130 21 13 270 SB	Aluminium Connection section - centre countersunk holes - incl. screws and plugs	30 mm	270 cm SB	sahara	16,20
130 11 13 100	Aluminium Connection section - centre countersunk holes	30 mm	100 cm SB	sahara	6,00
130 11 11 500	Aluminium Connection section - centre countersunk holes	30 mm	500 cm	silver	Op aanvraag
130 21 11 270	Aluminium Connection section - centre countersunk holes	30 mm	270 cm	silver	12,60
130 21 11 270 SB	Aluminium Connection section - centre countersunk holes - incl. screws and plugs	30 mm	270 cm SB	silver	15,30
130 11 11 100	Aluminium Connection section - centre countersunk holes	30 mm	100 cm SB	silver	5,65
130 21 11 090	Aluminium Connection section - centre countersunk holes	30 mm	90 cm SB	silver	5,30
130 21 12 270	Aluminium Connection section - centre countersunk holes	30 mm	270 cm	bronze	13,80
130 21 12 270 SB	Aluminium Connection section - centre countersunk holes - incl. screws and plugs	30 mm	270 cm SB	bronze	16,65
130 11 12 100	Aluminium Connection section - centre countersunk holes	30 mm	100 cm SB	bronze	6,15
130 21 14 270	Aluminium Connection section - centre countersunk holes	30 mm	270 cm	stainless steel matt	13,80
130 21 14 270 SB	Aluminium Connection section - centre countersunk holes - incl. screws and plugs	30 mm	270 cm SB	stainless steel matt	16,65
130 11 14 100	Aluminium Connection section - centre countersunk holes	30 mm	100 cm SB	stainless steel matt	6,15
130 21 14 090	Aluminium Connection section - centre countersunk holes	30 mm	90 cm SB	stainless steel matt	5,75
130 21 19 270	Aluminium Connection section - centre countersunk holes - incl. screws and plugs	30 mm	270 cm SB	stainless steel brushed	19,85
130 11 19 100	Aluminium Connection section - centre countersunk holes	30 mm	100 cm SB	stainless steel brushed	7,35
130 24 10 270	Aluminium Connection section - auto-adhesive	30 mm	270 cm S	gold	18,00
130 14 10 100	Aluminium Connection section - auto-adhesive	30 mm	100 cm SB	gold	6,90
130 24 10 090	Aluminium Connection section - auto-adhesive	30 mm	90 cm SB	gold	6,50
130 24 13 270	Aluminium Connection section - auto-adhesive	30 mm	270 cm S	sahara	18,00
130 14 13 100	Aluminium Connection section - auto-adhesive	30 mm	100 cm SB	sahara	6,90
130 24 13 090	Aluminium Connection section - auto-adhesive	30 mm	90 cm SB	sahara	6,50
130 24 11 270	Aluminium Connection section - auto-adhesive	30 mm	270 cm S	silver	17,05
130 14 11 100	Aluminium Connection section - auto-adhesive	30 mm	100 cm SB	silver	6,55
130 24 11 090	Aluminium Connection section - auto-adhesive	30 mm	90 cm SB	silver	6,15
130 24 12 270	Aluminium Connection section - auto-adhesive	30 mm	270 cm S	bronze	17,70
130 14 12 100	Aluminium Connection section - auto-adhesive	30 mm	100 cm SB	bronze	6,90
130 24 12 090	Aluminium Connection section - auto-adhesive	30 mm	90 cm SB	bronze	6,50
130 24 14 270	Aluminium Connection section - auto-adhesive	30 mm	270 cm S	stainless steel matt	17,70
130 14 14 100	Aluminium Connection section - auto-adhesive	30 mm	100 cm SB	stainless steel matt	6,90
130 24 14 090	Aluminium Connection section - auto-adhesive	30 mm	90 cm SB	stainless steel matt	6,50
130 24 19 270	Aluminium Connection section - auto-adhesive	30 mm	270 cm S	stainless steel brushed	20,95

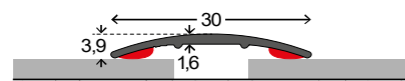

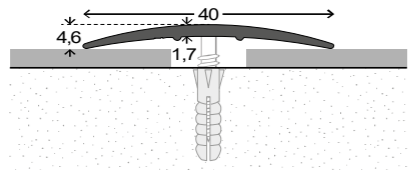
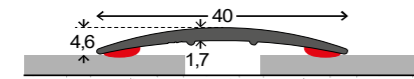
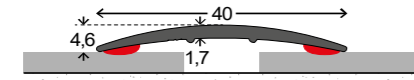
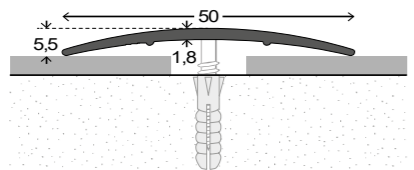
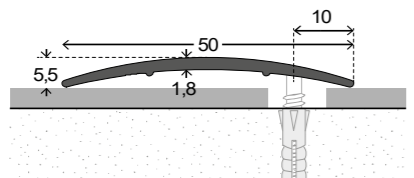
Schets	Artikelnummer	Omschrijving	Afmeting	Lengte	Kleur	Bruto verkoopprijs / st.
	130 14 19 100	Aluminium Connection section - auto-adhesive	30 mm	100 cm SB	stainless steel brushed	8,30
	130 14 32 300	Aluminium Connection section - auto-adhesive	30 mm	300 cm S	black powdercoated RAL 9005	19,80
	130 14 32 100	Aluminium Connection section - auto-adhesive	30 mm	100 cm SB	black powdercoated RAL 9005	7,35
	130 44 20 090	Aluminium Connection section - auto-adhesive	30 mm	90 cm SB	beech	7,85
	130 44 21 090	Aluminium Connection section - auto-adhesive	30 mm	90 cm SB	dark oak	7,85
	130 44 24 090	Aluminium Connection section - auto-adhesive	30 mm	90 cm SB	walnut	7,85
	130 44 25 090	Aluminium Connection section - auto-adhesive	30 mm	90 cm SB	light oak	7,85
	130 44 27 090	Aluminium Connection section - auto-adhesive	30 mm	90 cm SB	light grey oak	7,85
	130 44 28 090	Aluminium Connection section - auto-adhesive	30 mm	90 cm SB	grey oak	7,85
	136 21 10 270	Aluminium Connection section - centre countersunk holes	40 mm	270 cm	gold	22,45
	136 11 10 100	Aluminium Connection section - centre countersunk holes	40 mm	100 cm SB	gold	9,35
	136 21 13 270	Aluminium Connection section - centre countersunk holes	40 mm	270 cm	sahara	22,45
	136 11 13 100	Aluminium Connection section - centre countersunk holes	40 mm	100 cm SB	sahara	9,35
	136 21 11 270	Aluminium Connection section - centre countersunk holes	40 mm	270 cm	silver	20,80
	136 11 11 100	Aluminium Connection section - centre countersunk holes	40 mm	100 cm SB	silver	8,70
	136 21 14 270	Aluminium Connection section - centre countersunk holes	40 mm	270 cm	stainless steel matt	23,40
	136 11 14 100	Aluminium Connection section - centre countersunk holes	40 mm	100 cm SB	stainless steel matt	9,60
	136 24 10 270	Aluminium Connection section - auto-adhesive	40 mm	270 cm S	gold	23,90
	136 14 10 100	Aluminium Connection section - auto-adhesive	40 mm	100 cm SB	gold	9,55
	136 24 13 270	Aluminium Connection section - auto-adhesive	40 mm	270 cm S	sahara	23,90
	136 14 13 100	Aluminium Connection section - auto-adhesive	40 mm	100 cm SB	sahara	9,55
	136 24 11 270	Aluminium Connection section - auto-adhesive	40 mm	270 cm S	silver	22,55
	136 14 11 100	Aluminium Connection section - auto-adhesive	40 mm	100 cm SB	silver	9,10
	136 24 11 090	Aluminium Connection section - auto-adhesive	40 mm	90 cm SB	silver	8,30
	136 24 14 270	Aluminium Connection section - auto-adhesive	40 mm	270 cm S	stainless steel matt	23,90
	136 14 14 100	Aluminium Connection section - auto-adhesive	40 mm	100 cm SB	stainless steel matt	9,75
	136 24 19 270	Aluminium Connection section - auto-adhesive	40 mm	270 cm S	stainless steel brushed	29,60
	136 14 19 100	Aluminium Connection section - auto-adhesive	40 mm	100 cm SB	stainless steel brushed	12,20
	136 44 20 270	Aluminium Connection section - auto-adhesive	40 mm	270 cm S	beech	27,00
	136 44 20 090	Aluminium Connection section - auto-adhesive	40 mm	90 cm SB	beech	9,45
	136 44 21 270	Aluminium Connection section - auto-adhesive	40 mm	270 cm S	dark oak	27,00
	136 44 21 090	Aluminium Connection section - auto-adhesive	40 mm	90 cm SB	dark oak	9,45
	136 44 22 090	Aluminium Connection section - auto-adhesive	40 mm	90 cm SB	maple	9,45
	136 44 25 270	Aluminium Connection section - auto-adhesive	40 mm	270 cm S	light oak	27,00
	136 44 25 090	Aluminium Connection section - auto-adhesive	40 mm	90 cm SB	light oak	9,45
	137 21 10 270	Aluminium Connection section - centre countersunk holes	50 mm	270 cm S	gold	30,15
	137 11 10 100	Aluminium Connection section - centre countersunk holes	50 mm	100 cm SB	gold	12,20
	137 11 11 500	Aluminium Connection section - centre countersunk holes	50 mm	500 cm	silver	Op aanvraag
	137 21 11 270	Aluminium Connection section - centre countersunk holes	50 mm	270 cm S	silver	27,15
	137 11 11 100	Aluminium Connection section - centre countersunk holes	50 mm	100 cm SB	silver	11,05
	137 21 14 270	Aluminium Connection section - centre countersunk holes	50 mm	270 cm S	stainless steel matt	30,95
	137 11 14 100	Aluminium Connection section - centre countersunk holes	50 mm	100 cm SB	stainless steel matt	12,45
	137 12 11 500	Aluminium Connection section - lateral countersunk holes	50 mm	500 cm	silver	Op aanvraag
	137 22 11 270	Aluminium Connection section - lateral countersunk holes	50 mm	270 cm	silver	27,95
	137 12 14 500	Aluminium Connection section - lateral countersunk holes	50 mm	500 cm	stainless steel matt	Op aanvraag
	137 22 14 270	Aluminium Connection section - lateral countersunk holes	50 mm	270 cm	stainless steel matt	31,60

Schets	Artikelnummer	Omschrijving	Afmeting	Lengte	Kleur	Bruto verkoopprijs / st.
	137 24 10 270	Aluminium Connection section - auto-adhesive	50 mm	270 cm S	gold	31,35
	137 14 10 100	Aluminium Connection section - auto-adhesive	50 mm	100 cm SB	gold	11,90
	137 24 10 090	Aluminium Connection section - auto-adhesive	50 mm	90 cm SB	gold	10,80
	137 24 11 270	Aluminium Connection section - auto-adhesive	50 mm	270 cm S	silver	28,65
	137 14 11 100	Aluminium Connection section - auto-adhesive	50 mm	100 cm SB	silver	11,00
	137 24 11 090	Aluminium Connection section - auto-adhesive	50 mm	90 cm SB	silver	9,95
	137 24 14 270	Aluminium Connection section - auto-adhesive	50 mm	270 cm S	stainless steel matt	32,00
	137 14 14 100	Aluminium Connection section - auto-adhesive	50 mm	100 cm SB	stainless steel matt	12,20
	137 24 14 090	Aluminium Connection section - auto-adhesive	50 mm	90 cm SB	stainless steel matt	11,05
	134 23 10 270	Aluminium Connection section - centre countersunk holes	60 mm	270 cm S	gold	38,35
	134 11 10 100	Aluminium Connection section - centre countersunk holes	60 mm	100 cm SB	gold	15,30
	134 11 11 500	Aluminium Connection section - centre countersunk holes	60 mm	500 cm	silver	Op aanvraag
	134 23 11 270	Aluminium Connection section - centre countersunk holes	60 mm	270 cm S	silver	34,30
	134 11 11 100	Aluminium Connection section - centre countersunk holes	60 mm	100 cm SB	silver	13,65
	134 23 14 270	Aluminium Connection section - centre countersunk holes	60 mm	270 cm S	stainless steel matt	38,35
	134 11 14 100	Aluminium Connection section - centre countersunk holes	60 mm	100 cm SB	stainless steel matt	15,20
	134 12 11 500	Aluminium Connection section - lateral countersunk holes	60 mm	500 cm	silver	Op aanvraag
	134 22 11 270	Aluminium Connection section - lateral countersunk holes	60 mm	270 cm S	silver	36,05
	134 22 14 270	Aluminium Connection section - lateral countersunk holes	60 mm	270 cm S	stainless steel matt	39,30
	134 24 10 270	Aluminium Connection section - auto-adhesive	60 mm	270 cm S	gold	41,35
	134 14 10 100	Aluminium Connection section - auto-adhesive	60 mm	100 cm SB	gold	16,20
134 24 11 270	Aluminium Connection section - auto-adhesive	60 mm	270 cm S	silver	36,05	
134 14 11 100	Aluminium Connection section - auto-adhesive	60 mm	100 cm SB	silver	14,15	
134 24 14 270	Aluminium Connection section - auto-adhesive	60 mm	270 cm S	stainless steel matt	40,25	
134 14 14 100	Aluminium Connection section - auto-adhesive	60 mm	100 cm SB	stainless steel matt	15,75	
	118 11 11 500	Aluminium Connection section - centre countersunk holes	80 mm	500 cm S	silver	Op aanvraag
	118 21 11 270	Aluminium Connection section - centre countersunk holes	80 mm	270 cm S	silver	45,80
	118 11 11 100	Aluminium Connection section - centre countersunk holes	80 mm	100 cm S	silver	17,20
	118 11 14 500	Aluminium Connection section - centre countersunk holes	80 mm	500 cm S	stainless steel matt	Op aanvraag
	118 21 14 270	Aluminium Connection section - centre countersunk holes	80 mm	270 cm S	stainless steel matt	49,85
	118 11 14 100	Aluminium Connection section - centre countersunk holes	80 mm	100 cm S	stainless steel matt	18,60
	118 12 11 500	Aluminium Connection section - lateral countersunk holes	80 mm	500 cm S	silver	Op aanvraag
	118 22 11 270	Aluminium Connection section - lateral countersunk holes	80 mm	270 cm S	silver	45,80
	118 12 11 100	Aluminium Connection section - lateral countersunk holes	80 mm	100 cm S	silver	17,20
	118 12 14 500	Aluminium Connection section - lateral countersunk holes	80 mm	500 cm S	stainless steel matt	Op aanvraag
	118 22 14 270	Aluminium Connection section - lateral countersunk holes	80 mm	270 cm S	stainless steel matt	49,85
	118 12 14 100	Aluminium Connection section - lateral countersunk holes	80 mm	100 cm S	stainless steel matt	18,60
	118 10 11 500	Aluminium Connection section - without screw holes	80 mm	500 cm S	silver	Op aanvraag
	118 20 11 270	Aluminium Connection section - without screw holes	80 mm	270 cm S	silver	42,80
	118 10 11 100	Aluminium Connection section - without screw holes	80 mm	100 cm S	silver	16,30
	118 10 14 500	Aluminium Connection section - without screw holes	80 mm	500 cm S	stainless steel matt	Op aanvraag
	118 20 14 270	Aluminium Connection section - without screw holes	80 mm	270 cm S	stainless steel matt	47,55
	118 10 14 100	Aluminium Connection section - without screw holes	80 mm	100 cm S	stainless steel matt	18,25
	119 11 11 500	Aluminium Connection section - centre countersunk holes	100 mm	500 cm S	silver	Op aanvraag
	119 21 11 270	Aluminium Connection section - centre countersunk holes	100 mm	270 cm S	silver	55,25
	119 11 11 100	Aluminium Connection section - centre countersunk holes	100 mm	100 cm S	silver	20,70
	119 11 14 500	Aluminium Connection section - centre countersunk holes	100 mm	500 cm S	stainless steel matt	Op aanvraag
	119 21 14 270	Aluminium Connection section - centre countersunk holes	100 mm	270 cm S	stainless steel matt	59,95

Schets	Artikelnummer	Omschrijving	Afmeting	Lengte	Kleur	Bruto verkoopprijs / st.
	119 11 14 100	Aluminium Connection section - centre countersunk holes	100 mm	100 cm S	stainless steel matt	22,55
	119 12 11 500	Aluminium Connection section - lateral countersunk holes	100 mm	500 cm S	silver	Op aanvraag
	119 22 11 270	Aluminium Connection section - lateral countersunk holes	100 mm	270 cm S	silver	55,25
	119 12 11 100	Aluminium Connection section - lateral countersunk holes	100 mm	100 cm S	silver	20,70
	119 12 14 500	Aluminium Connection section - lateral countersunk holes	100 mm	500 cm S	stainless steel matt	Op aanvraag
	119 22 14 270	Aluminium Connection section - lateral countersunk holes	100 mm	270 cm S	stainless steel matt	59,95
	119 12 14 100	Aluminium Connection section - lateral countersunk holes	100 mm	100 cm S	stainless steel matt	22,55
	119 10 11 500	Aluminium Connection section - without screw holes	100 mm	500 cm S	silver	Op aanvraag
	119 20 11 270	Aluminium Connection section - without screw holes	100 mm	270 cm S	silver	52,65
	119 10 11 100	Aluminium Connection section - without screw holes	100 mm	100 cm S	silver	19,75
	119 10 14 500	Aluminium Connection section - without screw holes	100 mm	500 cm S	stainless steel matt	Op aanvraag
	119 20 14 270	Aluminium Connection section - without screw holes	100 mm	270 cm S	stainless steel matt	58,50
119 10 14 100	Aluminium Connection section - without screw holes	100 mm	100 cm S	stainless steel matt	21,90	
	150 24 11 270	Aluminium Connection section - auto-adhesive	80 mm	270 cm	silver	43,90
	150 14 11 100	Aluminium Connection section - auto-adhesive	80 mm	100 cm SB	silver	16,60
	150 24 14 270	Aluminium Connection section - auto-adhesive	80 mm	270 cm	stainless steel matt	48,10
	150 14 14 100	Aluminium Connection section - auto-adhesive	80 mm	100 cm SB	stainless steel matt	18,10
	151 24 11 270	Aluminium Connection section - auto-adhesive	100 mm	270 cm	silver	51,30
	151 14 11 100	Aluminium Connection section - auto-adhesive	100 mm	100 cm SB	silver	19,40
	151 24 14 270	Aluminium Connection section - auto-adhesive	100 mm	270 cm	stainless steel matt	56,30
	151 14 14 100	Aluminium Connection section - auto-adhesive	100 mm	100 cm SB	stainless steel matt	21,30
	114 24 13 270	Aluminium-connection section - auto-adhesive	24 mm	270 cm	sahara	16,90
	114 14 13 100	Aluminium-connection section - auto-adhesive	24 mm	100 cm SB	sahara	6,70
	114 24 11 270	Aluminium-connection section - auto-adhesive	24 mm	270 cm	silver	16,20
	114 14 11 100	Aluminium-connection section - auto-adhesive	24 mm	100 cm SB	silver	6,45
	114 24 14 270	Aluminium-connection section - auto-adhesive	24 mm	270 cm	stainless steel matt	17,85
	114 14 14 100	Aluminium-connection section - auto-adhesive	24 mm	100 cm SB	stainless steel matt	7,00
	114 24 32 270	Aluminium-connection section - auto-adhesive	24 mm	270 cm	black powdercoated RAL 9005	19,60
	114 14 32 100	Aluminium-connection section - auto-adhesive	24 mm	100 cm SB	black powdercoated RAL 9005	7,70
	115 21 10 270	Aluminium Connection section - centre countersunk holes	40 mm	270 cm S	gold	22,45
	115 11 10 100	Aluminium Connection section - centre countersunk holes	40 mm	100 cm SB	gold	9,10
	115 21 11 270	Aluminium Connection section - centre countersunk holes	40 mm	270 cm S	silver	20,70
	115 11 11 100	Aluminium Connection section - centre countersunk holes	40 mm	100 cm SB	silver	8,45
	115 21 14 270	Aluminium Connection section - centre countersunk holes	40 mm	270 cm S	stainless steel matt	22,55
	115 11 14 100	Aluminium Connection section - centre countersunk holes	40 mm	100 cm SB	stainless steel matt	9,10
	115 24 10 270	Aluminium Connection section - auto-adhesive	40 mm	270 cm S	gold	24,60
	115 14 10 100	Aluminium Connection section - auto-adhesive	40 mm	100 cm SB	gold	9,55
	115 24 11 270	Aluminium Connection section - auto-adhesive	40 mm	270 cm S	silver	22,70
	115 14 11 100	Aluminium Connection section - auto-adhesive	40 mm	100 cm SB	silver	8,90
	115 24 14 270	Aluminium Connection section - auto-adhesive	40 mm	270 cm S	stainless steel matt	24,75
	115 14 14 100	Aluminium Connection section - auto-adhesive	40 mm	100 cm SB	stainless steel matt	9,55
115 24 32 270	Aluminium-connection section - auto-adhesive	40 mm	270 cm S	black powdercoated RAL 9005	29,30	
115 14 32 100	Aluminium-connection section - auto-adhesive	40 mm	100 cm SB	black powdercoated RAL 9005	11,35	
	117 13 11 500	Aluminium Connection section - lateral shifted countersunk screw holes	80 mm	500 cm S	silver	Op aanvraag

Schets	Artikelnummer	Omschrijving	Afmeting	Lengte	Kleur	Bruto verkoopprijs / st.
	117 23 11 270	Aluminium Connection section - lateral shifted countersunk screw holes	80 mm	270 cm S	silver	47,00
	117 13 11 100	Aluminium Connection section - lateral shifted countersunk screw holes	80 mm	100 cm S	silver	17,70
	117 13 14 500	Aluminium Connection section - lateral shifted countersunk screw holes	80 mm	500 cm S	stainless steel matt	Op aanvraag
	117 23 14 270	Aluminium Connection section - lateral shifted countersunk screw holes	80 mm	270 cm S	stainless steel matt	49,85
	117 13 14 100	Aluminium Connection section - lateral shifted countersunk screw holes	80 mm	100 cm S	stainless steel matt	19,00
	117 24 10 270	Aluminium Connection section - auto-adhesive	80 mm	270 cm S	gold	59,30
	117 14 10 100	Aluminium Connection section - auto-adhesive	80 mm	100 cm S	gold	22,25
	117 24 11 270	Aluminium Connection section - auto-adhesive	80 mm	270 cm S	silver	54,70
	117 14 11 100	Aluminium Connection section - auto-adhesive	80 mm	100 cm S	silver	20,80
	117 24 14 270	Aluminium Connection section - auto-adhesive	80 mm	270 cm S	stainless steel matt	58,90
117 14 14 100	Aluminium Connection section - auto-adhesive	80 mm	100 cm S	stainless steel matt	21,95	
	133 23 10 270	Aluminium Connection section - centre countersunk holes	25 mm	270 cm	gold	13,80
	133 13 10 100	Aluminium Connection section - centre countersunk holes	25 mm	100 cm SB	gold	6,15
	133 23 11 270	Aluminium Connection section - centre countersunk holes	25 mm	270 cm	silver	13,40
	133 13 11 100	Aluminium Connection section - centre countersunk holes	25 mm	100 cm SB	silver	6,00
	133 23 12 270	Aluminium Connection section - centre countersunk holes	25 mm	270 cm	bronze	15,15
	133 13 12 100	Aluminium Connection section - centre countersunk holes	25 mm	100 cm SB	bronze	6,70
	133 23 14 270	Aluminium Connection section - centre countersunk holes	25 mm	270 cm	stainless steel matt	15,15
133 13 14 100	Aluminium Connection section - centre countersunk holes	25 mm	100 cm SB	stainless steel matt	6,70	
	133 24 10 270	Aluminium Connection section - auto-adhesive	25 mm	270 cm S	gold	16,75
	133 14 10 100	Aluminium Connection section - auto-adhesive	25 mm	100 cm SB	gold	6,75
	133 24 11 270	Aluminium Connection section - auto-adhesive	25 mm	270 cm S	silver	16,10
	133 14 11 100	Aluminium Connection section - auto-adhesive	25 mm	100 cm SB	silver	6,55
	133 24 14 270	Aluminium Connection section - auto-adhesive	25 mm	270 cm S	stainless steel matt	17,30
133 14 14 100	Aluminium Connection section - auto-adhesive	25 mm	100 cm SB	stainless steel matt	7,00	
	131 24 13 270	Aluminium Connection section - auto-adhesive	33 mm	270 cm SB	sahara	19,60
	131 14 13 100	Aluminium Connection section - auto-adhesive	33 mm	100 cm SB	sahara	7,75
	131 24 13 090	Aluminium Connection section - auto-adhesive	33 mm	90 cm SB	sahara	7,10
	131 24 11 270	Aluminium Connection section - auto-adhesive	33 mm	270 cm SB	silver	18,25
	131 14 11 100	Aluminium Connection section - auto-adhesive	33 mm	100 cm SB	silver	7,20
	131 24 11 090	Aluminium Connection section - auto-adhesive	33 mm	90 cm SB	silver	6,65
	131 24 14 270	Aluminium Connection section - auto-adhesive	33 mm	270 cm SB	stainless steel matt	19,85
	131 14 14 100	Aluminium Connection section - auto-adhesive	33 mm	100 cm SB	stainless steel matt	7,90
	131 24 14 090	Aluminium Connection section - auto-adhesive	33 mm	90 cm SB	stainless steel matt	7,30
131 14 24 100	Aluminium Connection section - auto-adhesive	33 mm	100 cm SB	walnut	9,10	
131 14 25 100	Aluminium Connection section - auto-adhesive	33 mm	100 cm SB	oak light	9,10	
	135 21 11 270	Aluminium Connection section - centre countersunk holes	30 mm	270 cm	silver	12,05
	135 21 11 090	Aluminium Connection section - centre countersunk holes	30 mm	90 cm SB	silver	5,70
	135 21 14 270	Aluminium Connection section - centre countersunk holes	30 mm	270 cm	stainless steel matt	13,65
	135 21 14 090	Aluminium Connection section - centre countersunk holes	30 mm	90 cm SB	stainless steel matt	6,30
	135 24 10 270	Aluminium Connection section - auto-adhesive	30 mm	270 cm S	gold	17,55
	135 24 10 090	Aluminium Connection section - auto-adhesive	30 mm	90 cm SB	gold	6,60
	135 24 11 270	Aluminium Connection section - auto-adhesive	30 mm	270 cm S	silver	16,65
	135 24 11 090	Aluminium Connection section - auto-adhesive	30 mm	90 cm SB	silver	6,25

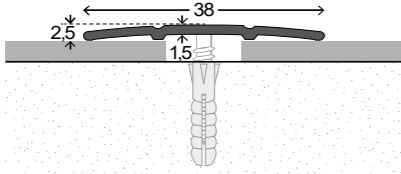
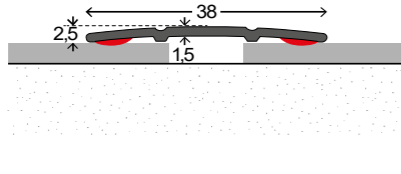
Schets	Artikelnummer	Omschrijving	Afmeting	Lengte	Kleur	Bruto verkoopprijs / st.
	135 24 14 270	Aluminium Connection section - auto-adhesive	30 mm	270 cm S	stainless steel matt	18,65
	135 24 14 090	Aluminium Connection section - auto-adhesive	30 mm	90 cm SB	stainless steel matt	7,00
	132 21 10 270	Aluminium Connection section - centre countersunk holes	38 mm	270 cm	gold	16,10
	132 21 10 270 SB	Aluminium Connection section - centre countersunk holes - incl. screws and plugs	38 mm	270 cm SB	gold	18,80
	132 11 10 100	Aluminium Connection section - centre countersunk holes	38 mm	100 cm SB	gold	7,50
	132 21 10 090	Aluminium Connection section - centre countersunk holes	38 mm	90 cm SB	gold	6,90
	132 21 13 270	Aluminium Connection section - centre countersunk holes	38 mm	270 cm	sahara	16,10
	132 21 13 270 SB	Aluminium Connection section - centre countersunk holes - incl. screws and plugs	38 mm	270 cm SB	sahara	18,80
	132 11 13 100	Aluminium Connection section - centre countersunk holes	38 mm	100 cm SB	sahara	7,50
	132 21 13 090	Aluminium Connection section - centre countersunk holes	38 mm	90 cm SB	sahara	6,90
	132 11 11 500	Aluminium Connection section - centre countersunk holes	38 mm	500 cm	silver	Op aanvraag
	132 11 11 300	Aluminium Connection section - centre countersunk holes	38 mm	300 cm	silver	16,50
	132 21 11 270	Aluminium Connection section - centre countersunk holes	38 mm	270 cm	silver	14,75
	132 21 11 270 SB	Aluminium Connection section - centre countersunk holes - incl. screws and plugs	38 mm	270 cm SB	silver	17,55
	132 11 11 100	Aluminium Connection section - centre countersunk holes	38 mm	100 cm SB	silver	7,00
	132 21 11 090	Aluminium Connection section - centre countersunk holes	38 mm	90 cm SB	silver	6,40
	132 21 12 270	Aluminium Connection section - centre countersunk holes	38 mm	270 cm	bronze	16,90
	132 11 12 100	Aluminium Connection section - centre countersunk holes	38 mm	100 cm SB	bronze	7,65
	132 21 12 090	Aluminium Connection section - centre countersunk holes	38 mm	90 cm SB	bronze	6,95
	132 11 14 300	Aluminium Connection section - centre countersunk holes	38 mm	300 cm	stainless steel matt	18,75
	132 21 14 270	Aluminium Connection section - centre countersunk holes	38 mm	270 cm	stainless steel matt	16,90
	132 21 14 270 SB	Aluminium Connection section - centre countersunk holes - incl. screws and plugs	38 mm	270 cm SB	stainless steel matt	19,75
	132 11 14 100	Aluminium Connection section - centre countersunk holes	38 mm	100 cm SB	stainless steel matt	7,65
	132 21 14 090	Aluminium Connection section - centre countersunk holes	38 mm	90 cm SB	stainless steel matt	6,95
	132 21 19 270	Aluminium Connection section - centre countersunk holes - incl. screws and plugs	38 mm	270 cm SB	stainless steel brushed	23,65
	132 11 19 100	Aluminium Connection section - centre countersunk holes	38 mm	100 cm SB	stainless steel brushed	9,45
	132 24 10 270	Aluminium Connection section - auto-adhesive	38 mm	270 cm S	gold	19,85
	132 14 10 100	Aluminium Connection section - auto-adhesive	38 mm	100 cm SB	gold	7,90
	132 24 10 090	Aluminium Connection section - auto-adhesive	38 mm	90 cm SB	gold	7,35
	132 24 13 270	Aluminium Connection section - auto-adhesive	38 mm	270 cm S	sahara	19,85
	132 14 13 100	Aluminium Connection section - auto-adhesive	38 mm	100 cm SB	sahara	7,90
	132 24 13 090	Aluminium Connection section - auto-adhesive	38 mm	90 cm SB	sahara	7,35
	132 14 11 300	Aluminium Connection section - auto-adhesive	38 mm	300 cm S	silver	20,85
	132 24 11 270	Aluminium Connection section - auto-adhesive	38 mm	270 cm S	silver	18,80
	132 14 11 100	Aluminium Connection section - auto-adhesive	38 mm	100 cm SB	silver	7,50
	132 24 11 090	Aluminium Connection section - auto-adhesive	38 mm	90 cm SB	silver	7,00
	132 14 12 300	Aluminium Connection section - auto-adhesive	38 mm	300 cm S	bronze	22,95
	132 24 12 270	Aluminium Connection section - auto-adhesive	38 mm	270 cm S	bronze	20,70
	132 14 12 100	Aluminium Connection section - auto-adhesive	38 mm	100 cm SB	bronze	8,15
	132 24 12 090	Aluminium Connection section - auto-adhesive	38 mm	90 cm SB	bronze	7,50
	132 14 14 300	Aluminium Connection section - auto-adhesive	38 mm	300 cm S	stainless steel matt	22,95
	132 24 14 270	Aluminium Connection section - auto-adhesive	38 mm	270 cm S	stainless steel matt	20,70
	132 14 14 100	Aluminium Connection section - auto-adhesive	38 mm	100 cm SB	stainless steel matt	8,15
	132 24 14 090	Aluminium Connection section - auto-adhesive	38 mm	90 cm SB	stainless steel matt	7,50
	132 24 19 270	Aluminium Connection section - auto-adhesive	38 mm	270 cm S	stainless steel brushed	24,05
	132 14 19 100	Aluminium Connection section - auto-adhesive	38 mm	100 cm SB	stainless steel brushed	9,35
	132 24 19 090	Aluminium Connection section - auto-adhesive	38 mm	90 cm SB	stainless steel brushed	8,40
	132 14 32 300	Aluminium Connection section - auto-adhesive	38 mm	300 cm S	black powdercoated RAL 9005	24,30

Schets	Artikelnummer	Omschrijving	Afmeting	Lengte	Kleur	Bruto verkoopprijs / st.
	132 14 32 100	Aluminium Connection section - auto-adhesive	38 mm	100 cm SB	black powdercoated RAL 9005	8,90
	132 24 50 270	Aluminium Connection section - auto-adhesive	38 mm	270 cm S	anthracite metallic	26,90
	132 14 50 100	Aluminium Connection section - auto-adhesive	38 mm	100 cm SB	anthracite metallic	10,25
	132 24 52 270	Aluminium Connection section - auto-adhesive	38 mm	270 cm S	grey metallic	26,90
	132 14 52 100	Aluminium Connection section - auto-adhesive	38 mm	100 cm SB	grey metallic	10,25
	132 24 53 270	Aluminium Connection section - auto-adhesive	38 mm	270 cm S	bronze metallic	26,90
	132 14 53 100	Aluminium Connection section - auto-adhesive	38 mm	100 cm SB	bronze metallic	10,25
	132 44 20 270	Aluminium Connection section - auto-adhesive	38 mm	270 cm S	beech	25,55
	132 14 20 100	Aluminium Connection section - auto-adhesive	38 mm	100 cm SB	beech	9,80
	132 44 20 090	Aluminium Connection section - auto-adhesive	38 mm	90 cm SB	beech	8,75
	132 44 21 270	Aluminium Connection section - auto-adhesive	38 mm	270 cm S	dark oak	25,55
	132 14 21 100	Aluminium Connection section - auto-adhesive	38 mm	100 cm SB	dark oak	9,80
	132 44 21 090	Aluminium Connection section - auto-adhesive	38 mm	90 cm SB	dark oak	8,75
	132 44 25 270	Aluminium Connection section - auto-adhesive	38 mm	270 cm S	light oak	25,55
	132 14 25 100	Aluminium Connection section - auto-adhesive	38 mm	100 cm SB	light oak	9,80
	132 44 25 090	Aluminium Connection section - auto-adhesive	38 mm	90 cm SB	light oak	8,75
	132 44 22 270	Aluminium Connection section - auto-adhesive	38 mm	270 cm S	maple	25,55
	132 14 22 100	Aluminium Connection section - auto-adhesive	38 mm	100 cm SB	maple	9,80
	132 44 22 090	Aluminium Connection section - auto-adhesive	38 mm	90 cm SB	maple	8,75
	132 44 24 270	Aluminium Connection section - auto-adhesive	38 mm	270 cm S	walnut	25,55
	132 14 24 100	Aluminium Connection section - auto-adhesive	38 mm	100 cm SB	walnut	9,80
	132 44 24 090	Aluminium Connection section - auto-adhesive	38 mm	90 cm SB	walnut	8,75
	132 44 27 270	Aluminium Connection section - auto-adhesive	38 mm	270 cm S	light grey oak	25,55
	132 14 27 100	Aluminium Connection section - auto-adhesive	38 mm	100 cm SB	light grey oak	9,80
	132 44 27 090	Aluminium Connection section - auto-adhesive	38 mm	90 cm SB	light grey oak	8,75
	132 44 28 270	Aluminium Connection section - auto-adhesive	38 mm	270 cm S	grey oak	25,55
	132 14 28 100	Aluminium Connection section - auto-adhesive	38 mm	100 cm SB	grey oak	9,80
	132 44 28 090	Aluminium Connection section - auto-adhesive	38 mm	90 cm SB	grey oak	8,75
	139 21 10 270	Aluminium Connection section reinforced - centre countersunk holes	37 mm	270 cm	gold	20,70
	139 11 10 100	Aluminium Connection section reinforced - centre countersunk holes	37 mm	100 cm SB	gold	8,70
	139 21 13 270	Aluminium Connection section reinforced - centre countersunk holes	37 mm	270 cm	sahara	20,70
	139 11 13 100	Aluminium Connection section reinforced - centre countersunk holes	37 mm	100 cm SB	sahara	8,70
	139 21 11 270	Aluminium Connection section reinforced - centre countersunk holes	37 mm	270 cm	silver	19,60
	139 11 11 100	Aluminium Connection section reinforced - centre countersunk holes	37 mm	100 cm SB	silver	8,25
	139 21 12 270	Aluminium Connection section reinforced - centre countersunk holes	37 mm	270 cm	bronze	21,35
	139 11 12 100	Aluminium Connection section reinforced - centre countersunk holes	37 mm	100 cm SB	bronze	8,85
	139 21 14 270	Aluminium Connection section reinforced - centre countersunk holes	37 mm	270 cm	stainless steel matt	21,35
	139 11 14 100	Aluminium Connection section reinforced - centre countersunk holes	37 mm	100 cm SB	stainless steel matt	8,85
	139 24 10 270	Aluminium Connection section reinforced - auto-adhesive	37 mm	270 cm S	gold	23,90
	139 14 10 100	Aluminium Connection section reinforced - auto-adhesive	37 mm	100 cm SB	gold	8,90
	139 24 13 270	Aluminium Connection section reinforced - auto-adhesive	37 mm	270 cm S	sahara	23,90
	139 14 13 100	Aluminium Connection section reinforced - auto-adhesive	37 mm	100 cm SB	sahara	8,90
	139 24 11 270	Aluminium Connection section reinforced - auto-adhesive	37 mm	270 cm S	silver	22,85
	139 14 11 100	Aluminium Connection section reinforced - auto-adhesive	37 mm	100 cm SB	silver	8,50
	139 24 11 090	Aluminium Connection section reinforced - auto-adhesive	37 mm	90 cm SB	silver	7,90
	139 24 12 270	Aluminium Connection section reinforced - auto-adhesive	37 mm	270 cm S	bronze	24,30
	139 14 12 100	Aluminium Connection section reinforced - auto-adhesive	37 mm	100 cm SB	bronze	9,20
	139 24 14 270	Aluminium Connection section reinforced - auto-adhesive	37 mm	270 cm S	stainless steel matt	24,30

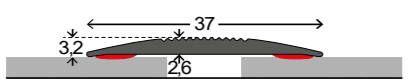
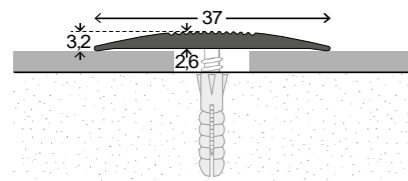
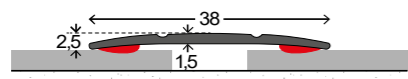

Schets	Artikelnummer	Omschrijving	Afmeting	Lengte	Kleur	Bruto verkoopprijs / st.
	139 14 14 100	Aluminium Connection section reinforced - auto-adhesive	37 mm	100 cm SB	stainless steel matt	9,20
	139 24 14 090	Aluminium Connection section reinforced - auto-adhesive	37 mm	90 cm SB	stainless steel matt	8,45

D.O.S. Connection Sections

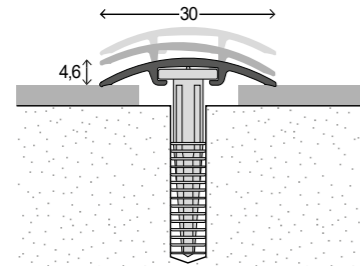

100 20 10 270	D.O.S. Aluminium Connection section - incl. Lamella anchors	30 mm	270 cm SB	gold	21,10
100 10 10 100	D.O.S. Aluminium Connection section - incl. Lamella anchors	30 mm	100 cm SB	gold	8,10
100 20 10 090	D.O.S. Aluminium Connection section - incl. Lamella anchors	30 mm	90 cm SB	gold	7,40
100 20 11 270	D.O.S. Aluminium Connection section - incl. Lamella anchors	30 mm	270 cm SB	silver	19,85
100 10 11 100	D.O.S. Aluminium Connection section - incl. Lamella anchors	30 mm	100 cm SB	silver	7,35
100 20 11 090	D.O.S. Aluminium Connection section - incl. Lamella anchors	30 mm	90 cm SB	silver	6,70
100 20 12 270	D.O.S. Aluminium Connection section - incl. Lamella anchors	30 mm	270 cm SB	bronze	21,75
100 10 12 100	D.O.S. Aluminium Connection section - incl. Lamella anchors	30 mm	100 cm SB	bronze	8,60
100 20 12 090	D.O.S. Aluminium Connection section - incl. Lamella anchors	30 mm	90 cm SB	bronze	7,80

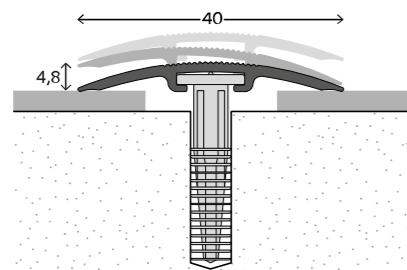

103 20 10 270	D.O.S. Aluminium Connection section - incl. Lamella anchors	40 mm	270 cm SB	gold	25,25
103 10 10 100	D.O.S. Aluminium Connection section - incl. Lamella anchors	40 mm	100 cm SB	gold	9,70
103 20 10 090	D.O.S. Aluminium Connection section - incl. Lamella anchors	40 mm	90 cm SB	gold	8,80
103 20 11 270	D.O.S. Aluminium Connection section - incl. Lamella anchors	40 mm	270 cm SB	silver	23,65
103 10 11 100	D.O.S. Aluminium Connection section - incl. Lamella anchors	40 mm	100 cm SB	silver	8,85
103 20 11 090	D.O.S. Aluminium Connection section - incl. Lamella anchors	40 mm	90 cm SB	silver	8,10
103 20 12 270	D.O.S. Aluminium Connection section - incl. Lamella anchors	40 mm	270 cm SB	bronze	27,00
103 10 12 100	D.O.S. Aluminium Connection section - incl. Lamella anchors	40 mm	100 cm SB	bronze	10,50
103 20 12 090	D.O.S. Aluminium Connection section - incl. Lamella anchors	40 mm	90 cm SB	bronze	9,60

Profile has decorative grooves.

Border Sections

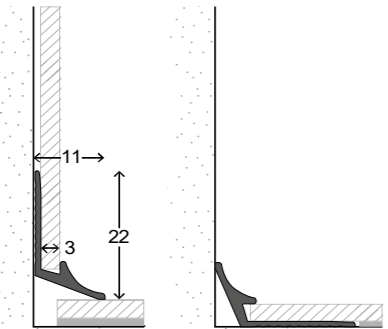

380 10 11 250	Aluminium Border section - without screw holes - for floor coverings 2,5 – 3 mm.	11 x 22 mm	250 cm	silver	12,25
380 10 14 250	Aluminium Border section - without screw holes - for floor coverings 2,5 – 3 mm.	11 x 22 mm	250 cm	stainless steel matt	14,40

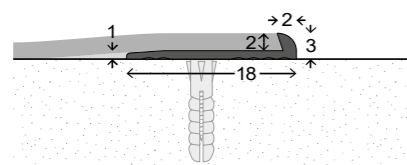

159 13 13 250	Aluminium Border section - countersunk screw holes - for floor coverings 2 mm.	18 x 3 mm	250 cm	sahara	11,00
159 13 11 250	Aluminium Border section - countersunk screw holes - for floor coverings 2 mm.	18 x 3 mm	250 cm	silver	10,40
159 13 14 250	Aluminium Border section - countersunk screw holes - for floor coverings 2 mm.	18 x 3 mm	250 cm	stainless steel matt	11,75

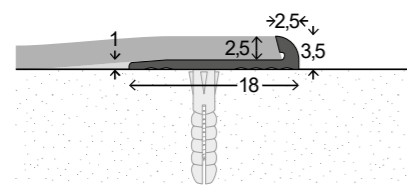

156 13 10 250	Aluminium Border section - countersunk screw holes - for floor coverings 2,5 mm.	18 x 3,5 mm	250 cm	gold	11,25
156 13 13 250	Aluminium Border section - countersunk screw holes - for floor coverings 2,5 mm.	18 x 3,5 mm	250 cm	sahara	11,25
156 13 11 250	Aluminium Border section - countersunk screw holes - for floor coverings 2,5 mm.	18 x 3,5 mm	250 cm	silver	10,50
156 13 14 250	Aluminium Border section - countersunk screw holes - for floor coverings 2,5 mm.	18 x 3,5 mm	250 cm	stainless steel matt	11,90
156 13 32 250	Aluminium Border section - countersunk screw holes - for floor coverings 2,5 mm.	18 x 3,5 mm	250 cm	black RAL 9005	13,25

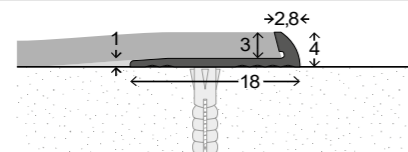

157 13 13 250	Aluminium Border section - countersunk screw holes - for floor coverings 3 mm.	18 x 4 mm	250 cm	sahara	11,40
157 13 11 250	Aluminium Border section - countersunk screw holes - for floor coverings 3 mm.	18 x 4 mm	250 cm	silver	10,90
157 13 11 250 SB	Aluminium Border section - countersunk screw holes - for floor coverings 3 mm - incl. fix	18 x 4 mm	250 cm SB	silver	13,50
157 13 14 250	Aluminium Border section - countersunk screw holes - for floor coverings 3 mm.	18 x 4 mm	250 cm	stainless steel matt	12,15

Schets	Artikelnummer	Omschrijving	Afmeting	Lengte	Kleur	Bruto verkoopprijs / st.
	157 13 32 250	Aluminium Border section - countersunk screw holes - for floor coverings 3 mm.	18 x 4 mm	250 cm	black RAL 9005	13,50

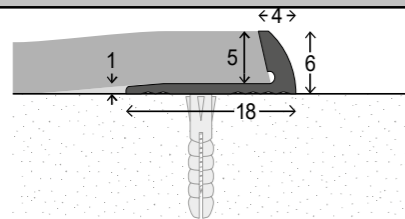

158 13 13 250	Aluminium Border section - countersunk screw holes - for floor coverings 5 mm.	18 x 6 mm	250 cm	sahara	13,00
158 13 11 250	Aluminium Border section - countersunk screw holes - for floor coverings 5 mm.	18 x 6 mm	250 cm	silver	12,25
158 13 14 250	Aluminium Border section - countersunk screw holes - for floor coverings 5 mm.	18 x 6 mm	250 cm	stainless steel matt	13,75
158 13 32 250	Aluminium Border section - countersunk screw holes - for floor coverings 5 mm.	18 x 6 mm	250 cm	black RAL 9005	15,40

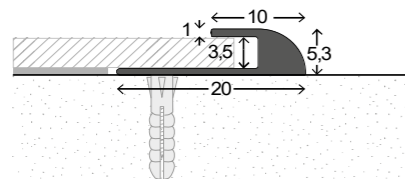

210 13 11 250	Aluminium-slide in/border section - countersunk holes - for floor coverings 3,0 - 3,5 mm	20 x 5,3 mm	250 cm	silver	13,50
210 13 14 250	Aluminium-slide in/border section - countersunk holes - for floor coverings 3,0 - 3,5 mm	20 x 5,3 mm	250 cm	stainless steel matt	15,00

Schets	Artikelnummer	Omschrijving	Afmeting	Lengte	Kleur	Bruto verkoopprijs / st.
	153 13 11 250	Aluminium Border section - countersunk screw holes - for floor coverings 5 mm.	20 x 7,4 mm	250 cm	silver	15,75
	153 13 14 250	Aluminium Border section - countersunk screw holes - for floor coverings 5 mm.	20 x 7,4 mm	250 cm	stainless steel matt	17,65
	141 20 11 270	Aluminium Border section - not perforated.	25 x 6 mm	270 cm	silver	13,25
	140 23 10 270	Aluminium Border section - with slotted screw holes	25 x 13,2 mm	270 cm	gold	15,70
	140 13 10 100	Aluminium Border section - with slotted screw holes	25 x 13,2 mm	100 cm SB	gold	6,85
	140 23 11 270	Aluminium Border section - with slotted screw holes	25 x 13,2 mm	270 cm	silver	14,45
	140 13 11 100	Aluminium Border section - with slotted screw holes	25 x 13,2 mm	100 cm SB	silver	6,40
	140 24 10 270	Aluminium Border section - auto-adhesive	25 x 13,2 mm	270 cm S	gold	19,75
	140 14 11 300	Aluminium Border section - auto-adhesive	25 x 13,2 mm	300 cm S	silver	21,00
	140 24 11 270	Aluminium Border section - auto-adhesive	25 x 13,2 mm	270 cm S	silver	18,90
	140 14 12 300	Aluminium Border section - auto-adhesive	25 x 13,2 mm	300 cm S	bronze	23,55
	140 24 12 270	Aluminium Border section - auto-adhesive	25 x 13,2 mm	270 cm S	bronze	21,35
	142 23 11 270	Aluminium Border section double sided	27,5 x 12 mm	270 cm	silver	24,75
	342 25 11 270	Aluminium Border section - with claw hook for fitted carpet	35,5 x 11,2 mm	270 cm	silver	13,95
	343 25 11 270	Aluminium Border section double sided - with claw hook for fitted carpet	27,5 x 12 mm	270 cm	silver	23,10

Schets	Artikelnummer	Omschrijving	Afmeting	Lengte	Kleur	Bruto verkoopprijs / st.

Slide-in Profiles

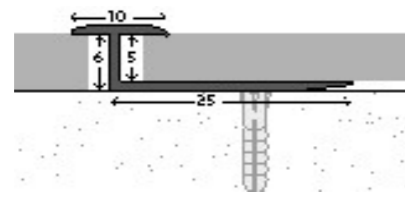

213 23 11 270	Aluminium-border section, double-sided - countersunk holes - for floor coverings 4,5 - 5	25 x 10 mm	270 cm	silver	15,80
213 23 14 270	Aluminium-border section, double-sided - countersunk holes - for floor coverings 4,5 - 5	25 x 10 mm	270 cm	stainless steel matt	17,70

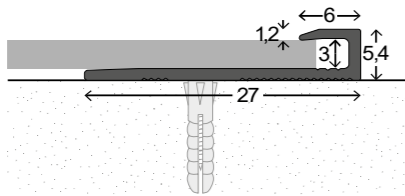

211 13 11 250	Aluminium Slide-in profile - countersunk screw holes - for covering thickness 2,5 - 3,0 mm	27 x 5,6 mm	250 cm	silver	14,40
211 13 11 250 SB	Aluminium Slide-in profile - countersunk screw holes - for covering thickness 2,5 - 3,0 mm	27 x 5,6 mm	250 cm	silver	17,00
211 13 14 250	Aluminium Slide-in profile - countersunk screw holes - for covering thickness 2,5 - 3,0 mm	27 x 5,6 mm	250 cm	stainless steel matt	15,90

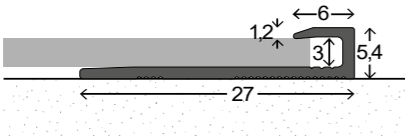

211 20 11 270	Aluminium Slide-in profile - without holes - for covering thicknesses 2,5 - 3,0 mm.	27 x 5,4 mm	270 cm S	silver	14,85
211 20 19 270	Aluminium Slide-in profile - without holes - for covering thicknesses 2,5 - 3,0 mm.	27 x 5,4 mm	270 cm S	stainless steel matt	18,40
211 20 32 270	Aluminium Slide-in profile - without holes - for covering thicknesses 2,5 - 3,0 mm.	27 x 5,4 mm	270 cm S	black RAL 9005	17,45

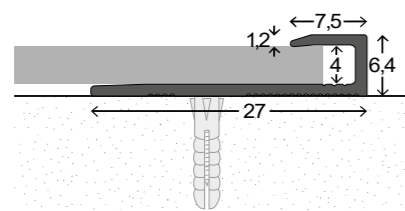

212 13 11 250	Aluminium Slide-in profile - countersunk screw holes - for covering thickness 3,5 - 4,0 mm	27 x 6,6 mm	250 cm	silver	15,15
212 13 14 250	Aluminium Slide-in profile - countersunk screw holes - for covering thickness 3,5 - 4,0 mm	27 x 6,6 mm	250 cm	stainless steel matt	16,50

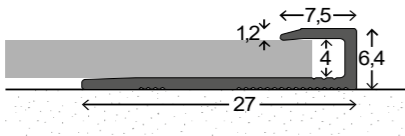

212 20 11 270	Aluminium Slide-in profile - without holes - for covering thicknesses 3,5 - 4,0 mm.	27 x 6,4 mm	270 cm S	silver	15,40
212 20 19 270	Aluminium Slide-in profile - without holes - for covering thicknesses 3,5 - 4,0 mm.	27 x 6,4 mm	270 cm S	stainless steel matt	18,90
212 20 32 270	Aluminium Slide-in profile - without holes - for covering thicknesses 3,5 - 4,0 mm.	27 x 6,4 mm	270 cm S	black RAL 9005	18,00

Schets	Artikelnummer	Omschrijving	Afmeting	Lengte	Kleur	Bruto verkoopprijs / st.
	143 13 13 250	Aluminium Slide-in profile - countersunk screw holes - for covering thickness 4,5 - 5,0 mm	27 x 7,6 mm	250 cm	sahara	17,50
	143 13 13 100	Aluminium Slide-in profile - countersunk screw holes - for covering thickness 4,5 - 5,0 mm	27 x 7,6 mm	100 cm	sahara	8,20
	143 13 11 250	Aluminium Slide-in profile - countersunk screw holes - for covering thickness 4,5 - 5,0 mm	27 x 7,6 mm	250 cm	silver	16,25
	143 13 11 100	Aluminium Slide-in profile - countersunk screw holes - for covering thickness 4,5 - 5,0 mm	27 x 7,6 mm	100 cm	silver	7,60
	143 13 14 250	Aluminium Slide-in profile - countersunk screw holes - for covering thickness 4,5 - 5,0 mm	27 x 7,6 mm	250 cm	stainless steel matt	18,40
	143 13 14 100	Aluminium Slide-in profile - countersunk screw holes - for covering thickness 4,5 - 5,0 mm	27 x 7,6 mm	100 cm	stainless steel matt	8,40

143 20 11 270	Aluminium Slide-in profile - without holes - for covering thicknesses 4,5 - 5,0 mm.	27 x 7,4 mm	270 cm S	silver	16,65
143 20 19 270	Aluminium Slide-in profile - without holes - for covering thicknesses 4,5 - 5,0 mm.	27 x 7,4 mm	270 cm S	stainless steel matt	20,25
143 20 32 270	Aluminium Slide-in profile - without holes - for covering thicknesses 4,5 - 5,0 mm.	27 x 7,4 mm	270 cm S	black RAL 9005	19,35

	144 13 13 250	Aluminium Slide-in profile - countersunk screw holes - for covering thickness 5,5 - 6,0 mm	27 x 8,6 mm	250 cm	sahara	18,50
	144 13 13 100	Aluminium Slide-in profile - countersunk screw holes - for covering thickness 5,5 - 6,0 mm	27 x 8,6 mm	100 cm	sahara	8,65
	144 13 11 250	Aluminium Slide-in profile - countersunk screw holes - for covering thickness 5,5 - 6,0 mm	27 x 8,6 mm	250 cm	silver	17,15
	144 13 11 100	Aluminium Slide-in profile - countersunk screw holes - for covering thickness 5,5 - 6,0 mm	27 x 8,6 mm	100 cm	silver	8,05
	144 13 14 250	Aluminium Slide-in profile - countersunk screw holes - for covering thickness 5,5 - 6,0 mm	27 x 8,6 mm	250 cm	stainless steel matt	19,40
	144 13 14 100	Aluminium Slide-in profile - countersunk screw holes - for covering thickness 5,5 - 6,0 mm	27 x 8,6 mm	100 cm	stainless steel matt	8,95

144 20 11 270	Aluminium Slide-in profile - without holes - for covering thicknesses 5,5 - 6,0 mm.	27 x 8,4 mm	270 cm S	silver	16,90
144 20 19 270	Aluminium Slide-in profile - without holes - for covering thicknesses 5,5 - 6,0 mm.	27 x 8,4 mm	270 cm S	stainless steel matt	20,55
144 20 32 270	Aluminium Slide-in profile - without holes - for covering thicknesses 5,5 - 6,0 mm.	27 x 8,4 mm	270 cm S	black RAL 9005	19,75

	147 20 11 270	Aluminium Slide-in profile - without holes - for covering thicknesses 6,5 - 7,0 mm.	27 x 9,4 mm	270 cm S	silver	17,15
	147 20 19 270	Aluminium Slide-in profile - without holes - for covering thicknesses 6,5 - 7,0 mm.	27 x 9,4 mm	270 cm S	stainless steel matt	20,80
	147 20 32 270	Aluminium Slide-in profile - without holes - for covering thicknesses 6,5 - 7,0 mm.	27 x 9,4 mm	270 cm S	black RAL 9005	20,00

	149 20 11 270	Aluminium Slide-in profile - without holes - for covering thicknesses 7,5 - 8,0 mm.	27 x 10,4 mm	270 cm S	silver	17,45
	149 20 19 270	Aluminium Slide-in profile - without holes - for covering thicknesses 7,5 - 8,0 mm.	27 x 10,4 mm	270 cm S	stainless steel matt	21,20
	149 20 32 270	Aluminium Slide-in profile - without holes - for covering thicknesses 7,5 - 8,0 mm.	27 x 10,4 mm	270 cm S	black RAL 9005	20,25

	152 20 11 270	Aluminium Slide-in profile - without holes - for covering thicknesses 8,5 - 9,0 mm.	27 x 11,4 mm	270 cm S	silver	17,85
	152 20 19 270	Aluminium Slide-in profile - without holes - for covering thicknesses 8,5 - 9,0 mm.	27 x 11,4 mm	270 cm S	stainless steel matt	21,60
	152 20 32 270	Aluminium Slide-in profile - without holes - for covering thicknesses 8,5 - 9,0 mm.	27 x 11,4 mm	270 cm S	black RAL 9005	20,80

Schets	Artikelnummer	Omschrijving	Afmeting	Lengte	Kleur	Bruto verkoopprijs / st.
--------	---------------	--------------	----------	--------	-------	--------------------------

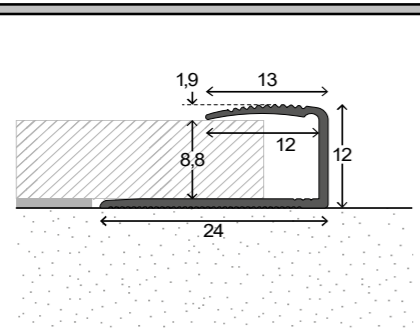

250 20 10 270	Aluminium Border section - without screw holes - for covering thicknesses 7 - 9 mm.	24 x 12 mm	270 cm	gold	16,90
250 20 10 090	Aluminium Border section - without screw holes - for covering thicknesses 7 - 9 mm.	24 x 12 mm	90 cm	gold	6,60
250 20 13 270	Aluminium Border section - without screw holes - for covering thicknesses 7 - 9 mm.	24 x 12 mm	270 cm	sahara	16,90
250 20 13 090	Aluminium Border section - without screw holes - for covering thicknesses 7 - 9 mm.	24 x 12 mm	90 cm	sahara	6,60
250 20 11 270	Aluminium Border section - without screw holes - for covering thicknesses 7 - 9 mm.	24 x 12 mm	270 cm	silver	15,70
250 20 11 090	Aluminium Border section - without screw holes - for covering thicknesses 7 - 9 mm.	24 x 12 mm	90 cm	silver	6,20
250 20 12 270	Aluminium Border section - without screw holes - for covering thicknesses 7 - 9 mm.	24 x 12 mm	270 cm	bronze	17,15
250 20 12 090	Aluminium Border section - without screw holes - for covering thicknesses 7 - 9 mm.	24 x 12 mm	90 cm	bronze	6,90
250 20 14 270	Aluminium Border section - without screw holes - for covering thicknesses 7 - 9 mm.	24 x 12 mm	270 cm	stainless steel matt	17,15
250 20 14 090	Aluminium Border section - without screw holes - for covering thicknesses 7 - 9 mm.	24 x 12 mm	90 cm	stainless steel matt	6,90

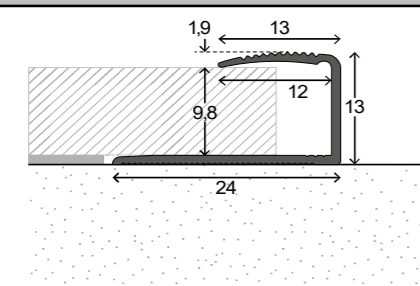

256 20 11 270	Aluminium Border section - without screw holes - for covering thicknesses 9 - 10 mm.	24 x 13 mm	270 cm	silver	16,75
256 20 14 270	Aluminium Border section - without screw holes - for covering thicknesses 9 - 10 mm.	24 x 13 mm	270 cm	stainless steel matt	18,65

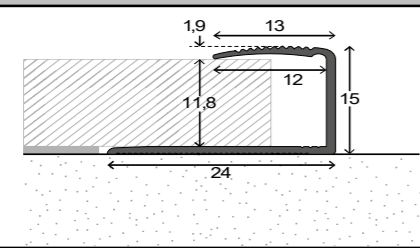

252 20 11 270	Aluminium Edge section - without screw holes - for covering thicknesses 10 - 12 mm.	24 x 15 mm	270 cm	silver	17,30
252 20 11 090	Aluminium Edge section - without screw holes - for covering thicknesses 10 - 12 mm.	24 x 15 mm	90 cm	silver	6,80
252 20 14 270	Aluminium Edge section - without screw holes - for covering thicknesses 10 - 12 mm.	24 x 15 mm	270 cm	stainless steel matt	19,35
252 20 14 090	Aluminium Edge section - without screw holes - for covering thicknesses 10 - 12 mm.	24 x 15 mm	90 cm	stainless steel matt	7,65

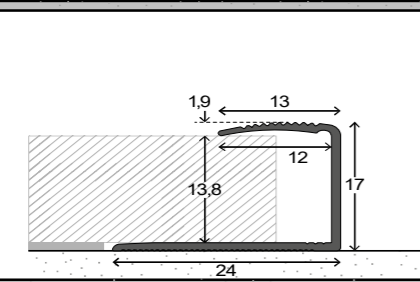

253 20 11 270	Aluminium Edge section - without screw holes - for covering thicknesses 12 - 14 mm.	24 x 17 mm	270 cm	silver	18,40
253 20 11 090	Aluminium Edge section - without screw holes - for covering thicknesses 12 - 14 mm.	24 x 17 mm	90 cm	silver	7,15
253 20 14 270	Aluminium Edge section - without screw holes - for covering thicknesses 12 - 14 mm.	24 x 17 mm	270 cm	stainless steel matt	20,40
253 20 14 090	Aluminium Edge section - without screw holes - for covering thicknesses 12 - 14 mm.	24 x 17 mm	90 cm	stainless steel matt	7,95

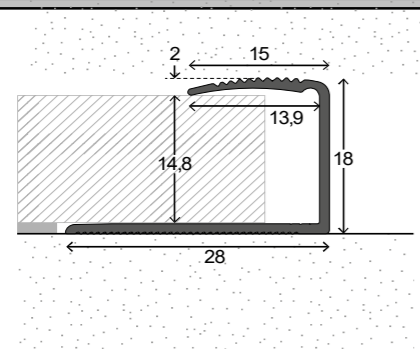

254 20 11 270	Aluminium Edge section - without screw holes - for covering thicknesses 14 - 15 mm.	28 x 18 mm	270 cm	silver	19,20
254 20 11 090	Aluminium Edge section - without screw holes - for covering thicknesses 14 - 15 mm.	28 x 18 mm	90 cm	silver	7,45
254 20 14 270	Aluminium Edge section - without screw holes - for covering thicknesses 14 - 15 mm.	28 x 18 mm	270 cm	stainless steel matt	21,50

Border and Ramp Sections						
145 23 10 270	Aluminium Border section - countersunk holes - for differences in level of 4 - 5 mm.	30 mm	270 cm	gold	16,35	

Schets	Artikelnummer	Omschrijving	Afmeting	Lengte	Kleur	Bruto verkoopprijs / st.	
	145 13 10 100	Aluminium Border section - countersunk holes - for differences in level of 4 - 5 mm.	30 mm	100 cm	gold	7,40	
	145 13 11 300	Aluminium Border section - countersunk holes - for differences in level of 4 - 5 mm.	30 mm	300 cm	silver	17,40	
	145 23 11 270	Aluminium Border section - countersunk holes - for differences in level of 4 - 5 mm.	30 mm	270 cm	silver	15,30	
	145 13 11 100	Aluminium Border section - countersunk holes - for differences in level of 4 - 5 mm.	30 mm	100 cm	silver	7,00	
	145 23 12 270	Aluminium Border section - countersunk holes - for differences in level of 4 - 5 mm.	30 mm	270 cm	bronze	17,85	
	145 13 12 100	Aluminium Border section - countersunk holes - for differences in level of 4 - 5 mm.	30 mm	100 cm	bronze	7,70	
	145 23 14 270	Aluminium Border section - countersunk holes - for differences in level of 4 - 5 mm.	30 mm	270 cm	stainless steel matt	17,85	
	145 13 14 100	Aluminium Border section - countersunk holes - for differences in level of 4 - 5 mm.	30 mm	100 cm	stainless steel matt	7,70	
	145 24 10 270	Aluminium Border section - auto-adhesive - for differences in level of 4 - 5 mm.	30 mm	270 cm	gold	20,15	
	145 14 11 300	Aluminium Border section - auto-adhesive - for differences in level of 4 - 5 mm.	30 mm	300 cm	silver	21,00	
	145 24 11 270	Aluminium Border section - auto-adhesive - for differences in level of 4 - 5 mm.	30 mm	270 cm	silver	18,90	
	145 14 11 100	Aluminium Border section - auto-adhesive - for differences in level of 4 - 5 mm.	30 mm	100 cm	silver	7,85	
	145 24 12 270	Aluminium Border section - auto-adhesive - for differences in level of 4 - 5 mm.	30 mm	270 cm	bronze	20,95	
	145 24 14 270	Aluminium Border section - auto-adhesive - for differences in level of 4 - 5 mm.	30 mm	270 cm	stainless steel matt	20,95	
	146 23 11 270	Aluminium Border section - countersunk holes - for differences in level of 8 mm.	32 mm	270 cm	silver	21,10	
	146 23 12 270	Aluminium Border section - countersunk holes - for differences in level of 8 mm.	32 mm	270 cm	bronze	23,50	
	146 24 10 270	Aluminium Border section - auto-adhesive - for differences in level of 8 mm.	32 mm	270 cm	gold	24,05	
	146 24 11 270	Aluminium Border section - auto-adhesive - for differences in level of 8 mm.	32 mm	270 cm	silver	22,70	
	146 14 11 100	Aluminium Border section - auto-adhesive - for differences in level of 8 mm.	32 mm	100 cm	silver	8,50	
	146 24 12 270	Aluminium Border section - auto-adhesive - for differences in level of 8 mm.	32 mm	270 cm	bronze	25,25	
	146 24 14 270	Aluminium Border section - auto-adhesive - for differences in level of 8 mm.	32 mm	270 cm	stainless steel matt	25,25	
	146 14 14 100	Aluminium Border section - auto-adhesive - for differences in level of 8 mm.	32 mm	100 cm	stainless steel matt	9,35	
	154 23 11 270	Aluminium Border section - countersunk holes - for differences in level of 14 mm.	44 mm	270 cm	silver	26,50	
		154 24 10 270	Aluminium Border section - auto-adhesive - for differences in level of 14 mm.	44 mm	270 cm	gold	30,40
		154 14 11 300	Aluminium Border section - auto-adhesive - for differences in level of 14 mm.	44 mm	300 cm	silver	31,35
		154 24 11 270	Aluminium Border section - auto-adhesive - for differences in level of 14 mm.	44 mm	270 cm	silver	28,25
		154 24 12 270	Aluminium Border section - auto-adhesive - for differences in level of 14 mm.	44 mm	270 cm	bronze	31,35
154 24 14 270		Aluminium Border section - auto-adhesive - for differences in level of 14 mm.	44 mm	270 cm	stainless steel matt	31,35	
	155 23 11 270	Aluminium Border section - countersunk holes - for differences in level of 22 mm.	52 mm	270 cm	silver	32,95	

Schets	Artikelnummer	Omschrijving	Afmeting	Lengte	Kleur	Bruto verkoopprijs / st.
--------	---------------	--------------	----------	--------	-------	--------------------------

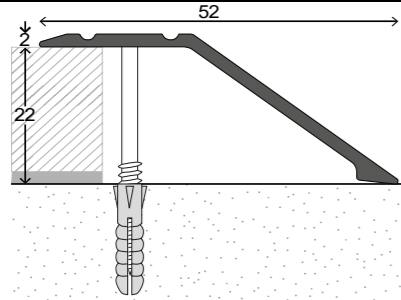

155 24 11 270	Aluminium Border section - auto-adhesive - for differences in level of 14 mm.	44 mm	270 cm S	bronze	31,90
---------------	---	-------	----------	--------	--------------

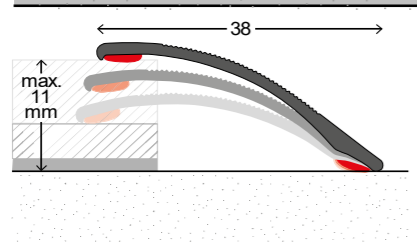
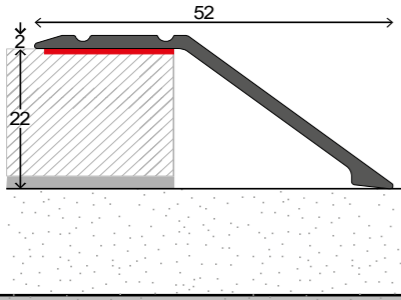

138 24 10 270	Aluminium Adaptation section - auto-adhesive - for differences in level up to 11 mm.	38 mm	270 cm S	gold	25,40
138 14 10 100	Aluminium Adaptation section - auto-adhesive - for differences in level up to 11 mm.	38 mm	100 cm SB	gold	10,25
138 24 10 090	Aluminium Adaptation section - auto-adhesive - for differences in level up to 11 mm.	38 mm	90 cm SB	gold	9,30
138 24 13 270	Aluminium Adaptation section - auto-adhesive - for differences in level up to 11 mm.	38 mm	270 cm S	sahara	25,40
138 14 13 100	Aluminium Adaptation section - auto-adhesive - for differences in level up to 11 mm.	38 mm	100 cm SB	sahara	10,25
138 24 13 090	Aluminium Adaptation section - auto-adhesive - for differences in level up to 11 mm.	38 mm	90 cm SB	sahara	9,30
138 24 11 270	Aluminium Adaptation section - auto-adhesive - for differences in level up to 11 mm.	38 mm	270 cm S	silver	24,05
138 14 11 100	Aluminium Adaptation section - auto-adhesive - for differences in level up to 11 mm.	38 mm	100 cm SB	silver	9,85
138 24 11 090	Aluminium Adaptation section - auto-adhesive - for differences in level up to 11 mm.	38 mm	90 cm SB	silver	8,85
138 24 12 270	Aluminium Adaptation section - auto-adhesive - for differences in level up to 11 mm.	38 mm	270 cm S	bronze	26,60
138 14 12 100	Aluminium Adaptation section - auto-adhesive - for differences in level up to 11 mm.	38 mm	100 cm SB	bronze	10,75
138 24 14 270	Aluminium Adaptation section - auto-adhesive - for differences in level up to 11 mm.	38 mm	270 cm S	stainless steel matt	26,60
138 14 14 100	Aluminium Adaptation section - auto-adhesive - for differences in level up to 11 mm.	38 mm	100 cm SB	stainless steel matt	10,75
138 24 14 090	Aluminium Adaptation section - auto-adhesive - for differences in level up to 11 mm.	38 mm	90 cm SB	stainless steel matt	9,75
138 14 32 300	Aluminium Adaptation section - auto-adhesive - for differences in level up to 11 mm.	38 mm	300 cm S	black powdercoated RAL 9005	33,15
138 14 32 100	Aluminium Adaptation section - auto-adhesive - for differences in level up to 11 mm.	38 mm	100 cm SB	black powdercoated RAL 9005	11,60

138 24 50 270	Aluminium Adaptation section - auto-adhesive - for differences in level up to 11 mm.	38 mm	270 cm S	anthracite metallic	30,65
138 14 50 100	Aluminium Adaptation section - auto-adhesive - for differences in level up to 11 mm.	38 mm	100 cm SB	anthracite metallic	11,90
138 24 52 270	Aluminium Adaptation section - auto-adhesive - for differences in level up to 11 mm.	38 mm	270 cm S	grey metallic	30,65
138 14 52 100	Aluminium Adaptation section - auto-adhesive - for differences in level up to 11 mm.	38 mm	100 cm SB	grey metallic	11,90
138 14 53 100	Aluminium Adaptation section - auto-adhesive - for differences in level up to 11 mm.	38 mm	100 cm SB	bronze metallic	11,90

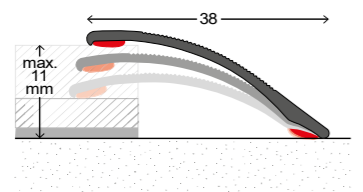

138 14 20 100	Aluminium Adaptation section - auto-adhesive - for differences in level up to 11 mm.	38 mm	100 cm SB	beech	11,90
138 24 20 090	Aluminium Adaptation section - auto-adhesive - for differences in level up to 11 mm.	38 mm	90 cm SB	beech	10,80
138 14 21 100	Aluminium Adaptation section - auto-adhesive - for differences in level up to 11 mm.	38 mm	100 cm SB	dark oak	11,90
138 14 25 100	Aluminium Adaptation section - auto-adhesive - for differences in level up to 11 mm.	38 mm	100 cm SB	light oak	11,90
138 14 22 100	Aluminium Adaptation section - auto-adhesive - for differences in level up to 11 mm.	38 mm	100 cm SB	maple	11,90
138 14 24 100	Aluminium Adaptation section - auto-adhesive - for differences in level up to 11 mm.	38 mm	100 cm SB	walnut	11,90
138 14 27 100	Aluminium Adaptation section - auto-adhesive - for differences in level up to 11 mm.	38 mm	100 cm SB	light grey oak	11,90
138 14 28 100	Aluminium Adaptation section - auto-adhesive - for differences in level up to 11 mm.	38 mm	100 cm SB	grey oak	11,90

148 24 13 270	Aluminium Adaptation section - auto-adhesive - for differences in level up to 14 mm.	40 mm	270 cm SB	sahara	27,95
---------------	--	-------	-----------	--------	--------------

Schets	Artikelnummer	Omschrijving	Afmeting	Lengte	Kleur	Bruto verkoopprijs / st.
	148 14 13 100	Aluminium Adaptation section - auto-adhesive - for differences in level up to 14 mm.	40 mm	100 cm SB	sahara	11,25
	148 24 11 270	Aluminium Adaptation section - auto-adhesive - for differences in level up to 14 mm.	40 mm	270 cm SB	silver	26,35
	148 14 11 100	Aluminium Adaptation section - auto-adhesive - for differences in level up to 14 mm.	40 mm	100 cm SB	silver	10,60
	148 24 14 270	Aluminium Adaptation section - auto-adhesive - for differences in level up to 14 mm.	40 mm	270 cm SB	stainless steel matt	28,90
	148 14 14 100	Aluminium Adaptation section - auto-adhesive - for differences in level up to 14 mm.	40 mm	100 cm SB	stainless steel matt	11,80
	148 24 19 270	Aluminium Adaptation section - auto-adhesive - for differences in level up to 14 mm.	40 mm	270 cm SB	stainless steel brushed	32,00
	148 14 19 100	Aluminium Adaptation section - auto-adhesive - for differences in level up to 14 mm.	40 mm	100 cm SB	stainless steel brushed	13,10

Ramp Sections

	169 13 13 250	Aluminium Ramp section - countersunk screw holes - for floor coverings 2,5 - 3 mm.	38 x 3,8 mm	250 cm	sahara	18,00
	169 13 11 250	Aluminium Ramp section - countersunk screw holes - for floor coverings 2,5 - 3 mm.	38 x 3,8 mm	250 cm	silver	16,75
	169 13 14 250	Aluminium Ramp section - countersunk screw holes - for floor coverings 2,5 - 3 mm.	38 x 3,8 mm	250 cm	stainless steel matt	18,90

	269 13 11 250	Aluminium Ramp section - countersunk screw holes - for floor coverings 4,5 - 5 mm.	39 x 6,8 mm	250 cm	silver	25,15
	269 13 14 250	Aluminium Ramp section - countersunk screw holes - for floor coverings 4,5 - 5 mm.	39 x 6,8 mm	250 cm	stainless steel matt	27,75

	262 23 11 270	Aluminium Ramp section - countersunk screw holes - for floor coverings 2 - 5 mm.	28 mm	270 cm	silver	15,00
	262 23 11 090	Aluminium Ramp section - countersunk screw holes - for floor coverings 2 - 5 mm.	28 mm	90 cm SB	silver	7,05
	262 23 14 270	Aluminium Ramp section - countersunk screw holes - for floor coverings 2 - 5 mm.	28 mm	270 cm	stainless steel matt	16,35

	262 20 11 270	Aluminium Ramp section - not perforated - for floor coverings 2 - 5 mm.	28 mm	270 cm	silver	12,45
	262 20 14 270	Aluminium Ramp section - not perforated - for floor coverings 2 - 5 mm.	28 mm	270 cm	stainless steel matt	13,65

	257 23 13 270	Aluminium Ramp section - countersunk screw holes - for floor coverings 5 - 7 mm.	35 mm	270 cm	sahara	26,10
	257 23 11 270	Aluminium Ramp section - countersunk screw holes - for floor coverings 5 - 7 mm.	35 mm	270 cm	silver	23,90
	257 23 14 270	Aluminium Ramp section - countersunk screw holes - for floor coverings 5 - 7 mm.	35 mm	270 cm	stainless steel matt	26,50

	257 20 13 270	Aluminium Ramp section - not perforated - for floor coverings 5 - 7 mm.	35 mm	270 cm	sahara	22,55
	257 20 11 270	Aluminium Ramp section - not perforated - for floor coverings 5 - 7 mm.	35 mm	270 cm	silver	20,70
	257 20 14 270	Aluminium Ramp section - not perforated - for floor coverings 5 - 7 mm.	35 mm	270 cm	stainless steel matt	22,95

	258 23 11 270	Aluminium Ramp section - countersunk screw holes - for floor coverings 4 - 7 mm.	38 mm	270 cm	silver	24,45
	258 23 14 270	Aluminium Ramp section - countersunk screw holes - for floor coverings 4 - 7 mm.	38 mm	270 cm	stainless steel matt	27,30

Schets	Artikelnummer	Omschrijving	Afmeting	Lengte	Kleur	Bruto verkoopprijs / st.
	259 23 11 270	Aluminium Ramp section - countersunk screw holes - for floor coverings 7,5 - 15 mm.	80 mm	270 cm	silver	60,50
	259 23 14 270	Aluminium Ramp section - countersunk screw holes - for floor coverings 7,5 - 15 mm.	80 mm	270 cm	stainless steel matt	65,75

Wall Connection Sections

- > Ideally suited for wall connections as well as for finishing balcony and patio doors and floor-to-ceiling windows.
- > Auto-adhesive finish - quick and easy installation.
- > Also available in the colour "white powder-coated" (RAL 9003) for door and window frames.

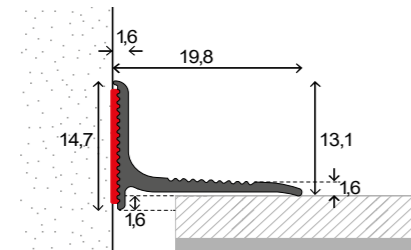

290 14 13 250	Aluminium Wall connection section - auto-adhesive.	19,8 x 13,1 mm	250 cm	S	sahara	19,50
290 14 13 100	Aluminium Wall connection section - auto-adhesive.	19,8 x 13,1 mm	100 cm	SB	sahara	9,20
290 14 11 250	Aluminium Wall connection section - auto-adhesive.	19,8 x 13,1 mm	250 cm	S	silver	17,90
290 14 11 100	Aluminium Wall connection section - auto-adhesive.	19,8 x 13,1 mm	100 cm	SB	silver	8,45
290 14 14 250	Aluminium Wall connection section - auto-adhesive.	19,8 x 13,1 mm	250 cm	S	stainless steel matt	20,15
290 14 14 100	Aluminium Wall connection section - auto-adhesive.	19,8 x 13,1 mm	100 cm	SB	stainless steel matt	9,60
290 14 30 250	Aluminium Wall connection section - auto-adhesive.	19,8 x 13,1 mm	250 cm	S	white powdercoated RAL 9003	23,65
290 14 30 100	Aluminium Wall connection section - auto-adhesive.	19,8 x 13,1 mm	100 cm	SB	white powdercoated RAL 9003	10,40

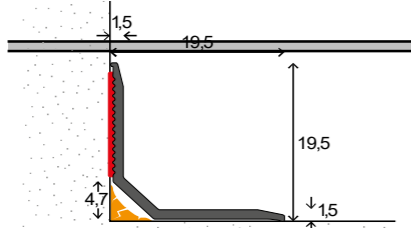

297 14 11 250	Aluminium Wall connection section - auto-adhesive.	19,5 x 19,5 mm	250 cm	S	silver	18,25
297 14 11 100	Aluminium Wall connection section - auto-adhesive.	19,5 x 19,5 mm	100 cm	SB	silver	8,45
297 14 14 250	Aluminium Wall connection section - auto-adhesive.	19,5 x 19,5 mm	250 cm	S	stainless steel matt	20,15
297 14 14 100	Aluminium Wall connection section - auto-adhesive.	19,5 x 19,5 mm	100 cm	SB	stainless steel matt	9,60
297 14 30 250	Aluminium Wall connection section - auto-adhesive.	19,5 x 19,5 mm	250 cm	S	white powdercoated RAL 9003	23,65
297 14 30 100	Aluminium Wall connection section - auto-adhesive.	19,5 x 19,5 mm	100 cm	SB	white powdercoated RAL 9003	10,60

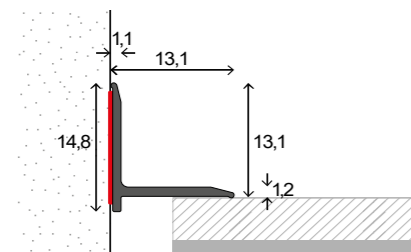

298 14 11 250	Aluminium Wall connection section - auto-adhesive.	13 x 13 mm	250 cm	S	silver	17,00
298 14 11 100	Aluminium Wall connection section - auto-adhesive.	13 x 13 mm	100 cm	SB	silver	8,00
298 14 14 250	Aluminium Wall connection section - auto-adhesive.	13 x 13 mm	250 cm	S	stainless steel matt	19,15
298 14 14 100	Aluminium Wall connection section - auto-adhesive.	13 x 13 mm	100 cm	SB	stainless steel matt	9,10
298 14 30 250	Aluminium Wall connection section - auto-adhesive.	13 x 13 mm	250 cm	S	white powdercoated RAL 9003	22,40
298 14 30 100	Aluminium Wall connection section - auto-adhesive.	13 x 13 mm	100 cm	SB	white powdercoated RAL 9003	9,90
298 14 32 250	Aluminium Wall connection section - auto-adhesive.	13 x 13 mm	250 cm	S	black powdercoated RAL 9005	22,40
298 14 32 100	Aluminium Wall connection section - auto-adhesive.	13 x 13 mm	100 cm	SB	black powdercoated RAL 9005	9,90

T-Cover-Profile

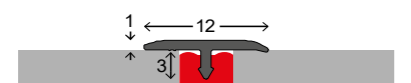

264 20 11 270	Aluminium T-Cover profile - bendable - web length 3 mm	12 mm	270 cm		silver	8,00
264 20 14 270	Aluminium T-Cover profile - bendable - web length 3 mm	12 mm	270 cm		stainless steel matt	9,45

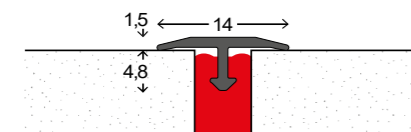

265 20 11 270	Aluminium T-Cover profile - bendable.	14 mm	270 cm		silver	10,70
265 20 14 270	Aluminium T-Cover profile - bendable.	14 mm	270 cm		stainless steel matt	12,70
265 20 32 270	Aluminium T-Cover profile - bendable.	14 mm	270 cm		black powdercoated RAL 9005	14,75

Schets	Artikelnummer	Omschrijving	Afmeting	Lengte	Kleur	Bruto verkoopprijs / st.
--------	---------------	--------------	----------	--------	-------	--------------------------

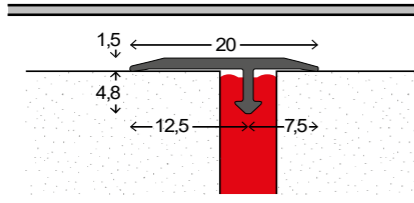

263 20 11 270	Aluminium T-Cover profile - with lateral bridge	20 mm	270 cm	silver	12,15
263 20 14 270	Aluminium T-Cover profile - with lateral bridge	20 mm	270 cm	stainless steel matt	14,35

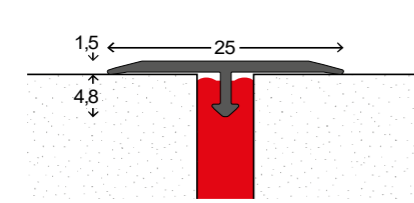

266 20 11 270	Aluminium T-Cover profile	25 mm	270 cm	silver	13,00
266 20 14 270	Aluminium T-Cover profile	25 mm	270 cm	stainless steel matt	15,40
266 20 32 270	Aluminium T-Cover profile	25 mm	270 cm	black powdercoated RAL 9005	17,85

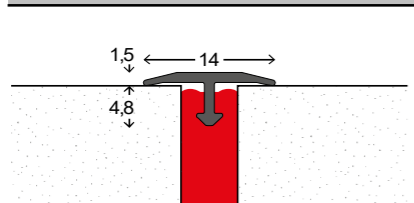

267 20 02 270	Brass T-Cover profile - bendable.	14 mm	270 cm	brass	22,85
267 20 03 270	Brass T-Cover profile - bendable.	14 mm	270 cm	brass polished	39,70

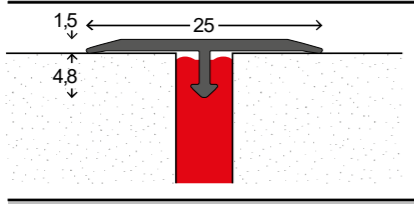

268 20 02 270	Brass T-Cover profile	25 mm	270 cm	brass	35,80
268 20 03 270	Brass T-Cover profile	25 mm	270 cm	brass polished	53,50

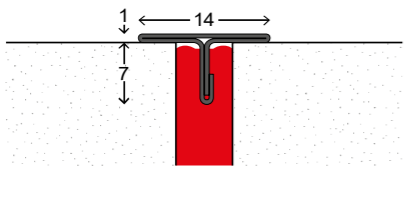

740 10 01 250	Stainless steel T-Cover profile	14 mm	250 cm	stainless steel	23,15
740 10 02 250	Stainless steel T-Cover profile	14 mm	250 cm	stainless steel brushed	30,90

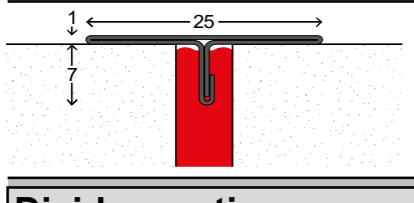

741 10 01 250	Stainless steel T-Cover profile	25 mm	250 cm	stainless steel	31,25
741 10 02 250	Stainless steel T-Cover profile	25 mm	250 cm	stainless steel brushed	39,00

Divider sections

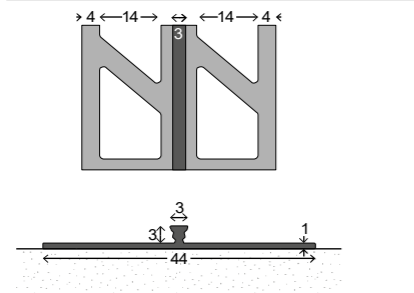

215 15 06 300	Aluminium Divider section - punched holes - for floor coverings 3 mm.	44 mm	300 cm	aluminium	17,85
---------------	---	-------	--------	-----------	--------------

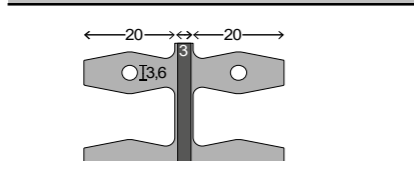

215 13 06 300	Aluminium Divider section - bendable (punched open) - for floor coverings 3 mm.	44 mm	300 cm	aluminium	23,55
---------------	---	-------	--------	-----------	--------------

Schets	Artikelnummer	Omschrijving	Afmeting	Lengte	Kleur	Bruto verkoopprijs / st.
--------	---------------	--------------	----------	--------	-------	--------------------------

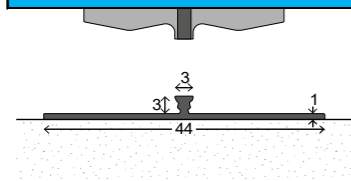

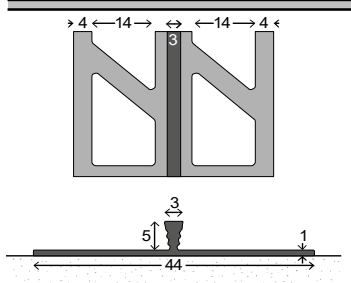
	214 15 06 300	Aluminium Divider section - punched holes - for floor coverings 5 mm.	44 mm	300 cm	aluminium	19,35
---	---------------	---	-------	--------	-----------	--------------

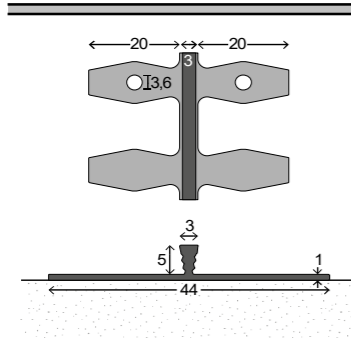

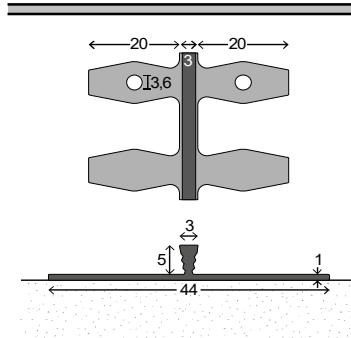
	214 13 06 300	Aluminium Divider section - bendable (punched open) - for floor coverings 5 mm.	44 mm	300 cm	aluminium	25,05
---	---------------	---	-------	--------	-----------	--------------

Aluminium Border Sections

- > Border section for wide expansion joints and fire predection joints.
- > The 45 mm wide profile bridges the expansion joint and creates a resilient, absorbent substrate.
- > Suitable for all types of floor coverings.
- > For floor coverings up to 3 mm thick, can also be used as an expansion joint profile in the room.

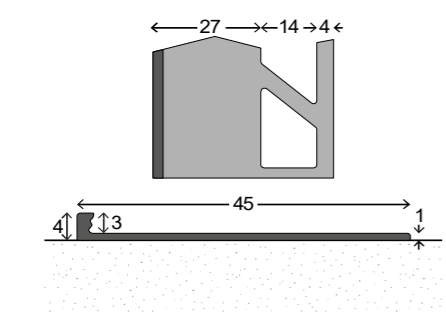

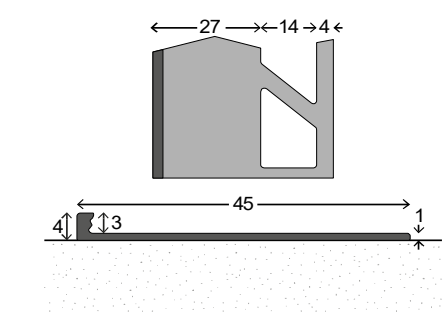
	718 15 06 300	Border section - punched holes to bridge wide expansion joints - for floor coverings 3 mm	4 x 45 mm	300 cm	aluminium	13,50
---	---------------	---	-----------	--------	-----------	--------------

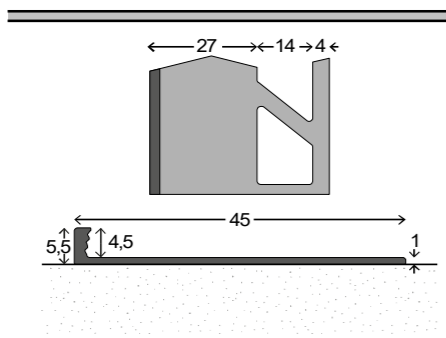

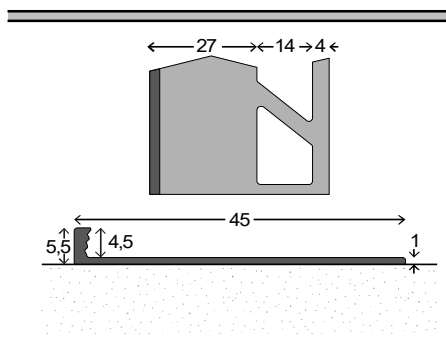
	736 15 06 300	Border section - punched holes to bridge wide expansion joints - for floor coverings 4,5 mm	5,5 x 45 mm	300 cm	aluminium	14,25
---	---------------	---	-------------	--------	-----------	--------------

	737 15 06 300	Border section - punched holes to bridge wide expansion joints - for floor coverings 6 mm	7 x 45 mm	300 cm	aluminium	14,85
--	---------------	---	-----------	--------	-----------	--------------

Schets	Artikelnummer	Omschrijving	Afmeting	Lengte	Kleur	Bruto verkoopprijs / st.
--------	---------------	--------------	----------	--------	-------	--------------------------

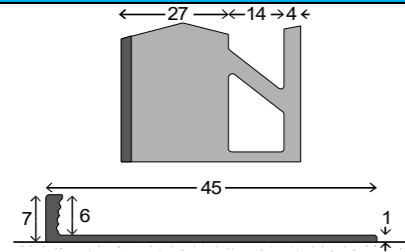

Aluminium Border Sections

Unpunched for cast floors.

709 10 11 250	Aluminium Border section - unpunched - for covering thicknesses 2,5 mm.	2,5 mm	250 cm	aluminium	7,65
---------------	---	--------	--------	-----------	-------------

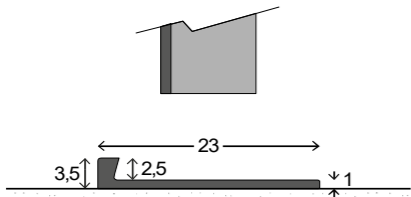

700 10 11 250	Aluminium Border section - unpunched - for covering thicknesses 3 mm.	3 mm	250 cm	aluminium	7,75
---------------	---	------	--------	-----------	-------------

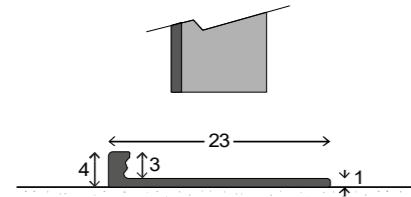

701 10 11 250	Aluminium Border section - unpunched - for covering thicknesses 4,5 mm.	4,5 mm	250 cm	aluminium	8,15
---------------	---	--------	--------	-----------	-------------

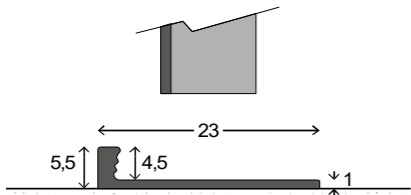

719 15 06 300	Aluminium Border section - punched holes - for covering thicknesses 2 mm.	2 mm	300 cm	aluminium natural	8,10
719 15 06 250	Aluminium Border section - punched holes - for covering thicknesses 2 mm.	2 mm	250 cm	aluminium natural	6,75
719 15 11 250	Aluminium Border section - punched holes - for covering thicknesses 2 mm.	2 mm	250 cm	silver	8,00

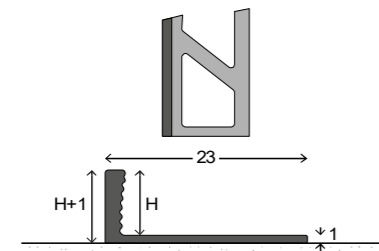

709 15 06 300	Aluminium Border section - punched holes - for covering thicknesses 2,5 mm.	2,5 mm	300 cm	aluminium natural	8,25
709 15 06 250	Aluminium Border section - punched holes - for covering thicknesses 2,5 mm.	2,5 mm	250 cm	aluminium natural	6,90
709 15 11 250	Aluminium Border section - punched holes - for covering thicknesses 2,5 mm.	2,5 mm	250 cm	silver	8,25
709 15 32 250	Aluminium Border section - punched holes - for covering thicknesses 2,5 mm.	2,5 mm	250 cm	black powdercoated RAL 9005	10,65

700 15 06 300	Aluminium Border section - punched holes - for covering thicknesses 3 mm.	3 mm	300 cm	aluminium natural	8,40
700 15 06 250	Aluminium Border section - punched holes - for covering thicknesses 3 mm.	3 mm	250 cm	aluminium natural	7,00
700 15 11 250	Aluminium Border section - punched holes - for covering thicknesses 3 mm.	3 mm	250 cm	silver	8,40
700 15 32 250	Aluminium Border section - punched holes - for covering thicknesses 3 mm.	3 mm	250 cm	black powdercoated RAL 9005	11,00

701 15 06 300	Aluminium Border section - punched holes - for covering thicknesses 4 - 4,5 mm.	4,5 mm	300 cm	aluminium natural	8,55
---------------	---	--------	--------	-------------------	-------------

Schets	Artikelnummer	Omschrijving	Afmeting	Lengte	Kleur	Bruto verkoopprijs / st.
	701 15 06 250	Aluminium Border section - punched holes - for covering thicknesses 4 - 4,5 mm.	4,5 mm	250 cm	aluminium natural	7,15
	701 15 11 250	Aluminium Border section - punched holes - for covering thicknesses 4 - 4,5 mm.	4,5 mm	250 cm	silver	8,65
	701 15 32 250	Aluminium Border section - punched holes - for covering thicknesses 4 - 4,5 mm.	4,5 mm	250 cm	black powdercoated RAL 9005	11,25
	702 15 06 300	Aluminium Border section - punched holes - for covering thicknesses 6 mm.	6 mm	300 cm	aluminium natural	8,70
	702 15 06 250	Aluminium Border section - punched holes - for covering thicknesses 6 mm.	6 mm	250 cm	aluminium natural	7,25
	702 15 11 300	Aluminium Border section - punched holes - for covering thicknesses 6 mm.	6 mm	300 cm	silver	10,65
	702 15 11 250	Aluminium Border section - punched holes - for covering thicknesses 6 mm.	6 mm	250 cm	silver	8,90
	702 15 30 250	Aluminium Border section - punched holes - for covering thicknesses 6 mm.	6 mm	250 cm	white powdercoated	9,90
	702 15 32 250	Aluminium Border section - punched holes - for covering thicknesses 6 mm.	6 mm	250 cm	black powdercoated RAL 9005	9,90
	703 15 06 300	Aluminium Border section - punched holes - for covering thicknesses 8 mm.	8 mm	300 cm	aluminium natural	9,30
	703 15 06 250	Aluminium Border section - punched holes - for covering thicknesses 8 mm.	8 mm	250 cm	aluminium natural	7,75
	703 15 11 300	Aluminium Border section - punched holes - for covering thicknesses 8 mm.	8 mm	300 cm	silver	11,10
	703 15 11 250	Aluminium Border section - punched holes - for covering thicknesses 8 mm.	8 mm	250 cm	silver	9,25
	703 15 30 250	Aluminium Border section - punched holes - for covering thicknesses 8 mm.	8 mm	250 cm	white powdercoated	10,25
	703 15 32 250	Aluminium Border section - punched holes - for covering thicknesses 8 mm.	8 mm	250 cm	black powdercoated RAL 9005	10,25
	704 15 06 300	Aluminium Border section - punched holes - for covering thicknesses 10 mm.	10 mm	300 cm	aluminium natural	9,45
	704 15 06 250	Aluminium Border section - punched holes - for covering thicknesses 10 mm.	10 mm	250 cm	aluminium natural	8,00
	704 15 11 300	Aluminium Border section - punched holes - for covering thicknesses 10 mm.	10 mm	300 cm	silver	11,70
	704 15 11 250	Aluminium Border section - punched holes - for covering thicknesses 10 mm.	10 mm	250 cm	silver	9,65
	704 15 30 250	Aluminium Border section - punched holes - for covering thicknesses 10 mm.	10 mm	250 cm	white powdercoated	10,90
	704 15 32 250	Aluminium Border section - punched holes - for covering thicknesses 10 mm.	10 mm	250 cm	black powdercoated RAL 9005	10,90
	708 15 06 300	Aluminium Border section - punched holes - for covering thicknesses 11 mm.	11 mm	300 cm	aluminium natural	9,90
	708 15 06 250	Aluminium Border section - punched holes - for covering thicknesses 11 mm.	11 mm	250 cm	aluminium natural	8,25
	708 15 11 300	Aluminium Border section - punched holes - for covering thicknesses 11 mm.	11 mm	300 cm	silver	12,00
	708 15 11 250	Aluminium Border section - punched holes - for covering thicknesses 11 mm.	11 mm	250 cm	silver	10,00
	708 15 30 250	Aluminium Border section - punched holes - for covering thicknesses 11 mm.	11 mm	250 cm	white powdercoated	11,50
	708 15 32 250	Aluminium Border section - punched holes - for covering thicknesses 11 mm.	11 mm	250 cm	black powdercoated RAL 9005	11,50
	705 15 06 300	Aluminium Border section - punched holes - for covering thicknesses 12,5 mm.	12,5 mm	300 cm	aluminium natural	10,35
	705 15 06 250	Aluminium Border section - punched holes - for covering thicknesses 12,5 mm.	12,5 mm	250 cm	aluminium natural	8,65
	705 15 11 300	Aluminium Border section - punched holes - for covering thicknesses 12,5 mm.	12,5 mm	300 cm	silver	12,45
	705 15 11 250	Aluminium Border section - punched holes - for covering thicknesses 12,5 mm.	12,5 mm	250 cm	silver	10,40
	705 15 30 250	Aluminium Border section - punched holes - for covering thicknesses 12,5 mm.	12,5 mm	250 cm	white powdercoated	11,75
	705 15 32 250	Aluminium Border section - punched holes - for covering thicknesses 12,5 mm.	12,5 mm	250 cm	black powdercoated RAL 9005	11,75
	706 15 06 300	Aluminium Border section - punched holes - for covering thicknesses 15 mm.	15 mm	300 cm	aluminium natural	11,25
	706 15 06 250	Aluminium Border section - punched holes - for covering thicknesses 15 mm.	15 mm	250 cm	aluminium natural	9,40
	706 15 11 300	Aluminium Border section - punched holes - for covering thicknesses 15 mm.	15 mm	300 cm	silver	13,65
	706 15 11 250	Aluminium Border section - punched holes - for covering thicknesses 15 mm.	15 mm	250 cm	silver	11,40
	707 15 06 250	Aluminium Border section - punched holes - for covering thicknesses 22 mm.	22 mm	250 cm	aluminium natural	12,00
	707 15 11 250	Aluminium Border section - punched holes - for covering thicknesses 22 mm.	22 mm	250 cm	silver	14,75
Border Section, brass						
	710 15 02 250	Brass Border section - punched holes - for floor coverings 2 -3 mm.	3 mm	250 cm	brass	33,45
	711 15 02 250	Brass Border section - punched holes - for floor coverings 4 - 4,5 mm.	4,5 mm	250 cm	brass	34,35



Schets	Artikelnummer	Omschrijving	Afmeting	Lengte	Kleur	Bruto verkoopprijs / st.
	712 15 02 250	Brass Border section - punched holes - for floor coverings 6 mm.	6 mm	250 cm	brass	37,75
	713 15 02 250	Brass Border section - punched holes - for floor coverings 8 mm.	8 mm	250 cm	brass	41,80
	714 15 02 250	Brass Border section - punched holes - for floor coverings 10 mm.	10 mm	250 cm	brass	45,70
	715 15 02 250	Brass Border section - punched holes - for floor coverings 12,5 mm.	12,5 mm	250 cm	brass	49,60
	716 15 02 250	Brass Border section - punched holes - for floor coverings 15 mm.	15 mm	250 cm	brass	53,55
	717 15 02 250	Brass Border section - punched holes - for floor coverings 22 mm.	22 mm	250 cm	brass	70,45

Border Section, stainless steel

	729 15 01 300	Stainless steel border section - punched holes - for floor coverings 2 - 2,5 mm.	2,5 mm	300 cm	stainless steel	26,10
	729 15 01 250	Stainless steel border section - punched holes - for floor coverings 2 - 2,5 mm.	2,5 mm	250 cm	stainless steel	21,75
	720 15 01 300	Stainless steel border section - punched holes - for floor coverings 2 - 3 mm.	3 mm	300 cm	stainless steel	26,10
	720 15 01 250	Stainless steel border section - punched holes - for floor coverings 2 - 3 mm.	3 mm	250 cm	stainless steel	21,75
	721 15 01 300	Stainless steel border section - punched holes - for floor coverings 4 - 4,5 mm.	4,5 mm	300 cm	stainless steel	26,25
	721 15 01 250	Stainless steel border section - punched holes - for floor coverings 4 - 4,5 mm.	4,5 mm	250 cm	stainless steel	21,90
	722 15 01 300	Stainless steel border section - punched holes - for floor coverings 6 mm.	6 mm	300 cm	stainless steel	26,25
	722 15 01 250	Stainless steel border section - punched holes - for floor coverings 6 mm.	6 mm	250 cm	stainless steel	21,90
	723 15 01 300	Stainless steel border section - punched holes - for floor coverings 8 mm.	8 mm	300 cm	stainless steel	26,55
	723 15 01 250	Stainless steel border section - punched holes - for floor coverings 8 mm.	8 mm	250 cm	stainless steel	22,15
	724 15 01 300	Stainless steel border section - punched holes - for floor coverings 10 mm.	10 mm	300 cm	stainless steel	27,15
	724 15 01 250	Stainless steel border section - punched holes - for floor coverings 10 mm.	10 mm	250 cm	stainless steel	22,65
	728 15 01 300	Stainless steel border section - punched holes - for floor coverings 11 mm.	11 mm	300 cm	stainless steel	27,60
	728 15 01 250	Stainless steel border section - punched holes - for floor coverings 11 mm.	11 mm	250 cm	stainless steel	23,00
725 15 01 300	Stainless steel border section - punched holes - for floor coverings 12,5 mm.	12,5 mm	300 cm	stainless steel	28,65	
725 15 01 250	Stainless steel border section - punched holes - for floor coverings 12,5 mm.	12,5 mm	250 cm	stainless steel	23,90	
726 15 01 300	Stainless steel border section - punched holes - for floor coverings 15 mm.	15 mm	300 cm	stainless steel	30,15	
726 15 01 250	Stainless steel border section - punched holes - for floor coverings 15 mm.	15 mm	250 cm	stainless steel	25,15	
727 15 01 250	Stainless steel border section - punched holes - for floor coverings 22 mm.	22 mm	250 cm	stainless steel	34,40	

Impact resistant PVC border section

	732 15 30 250	PVC border section - punched holes - for floor coverings 6 mm.	6 mm	250 cm	pure white	4,40
	732 15 34 250	PVC border section - punched holes - for floor coverings 6 mm.	6 mm	250 cm	signal white	4,40
	732 15 42 250	PVC border section - punched holes - for floor coverings 6 mm.	6 mm	250 cm	manhattan grey	4,40
	733 15 30 250	PVC border section - punched holes - for floor coverings 8 mm.	8 mm	250 cm	pure white	4,50
	733 15 34 250	PVC border section - punched holes - for floor coverings 8 mm.	8 mm	250 cm	signal white	4,50
	733 15 42 250	PVC border section - punched holes - for floor coverings 8 mm.	8 mm	250 cm	manhattan grey	4,50
	734 15 30 250	PVC border section - punched holes - for floor coverings 10 mm.	10 mm	250 cm	pure white	4,90
	734 15 34 250	PVC border section - punched holes - for floor coverings 10 mm.	10 mm	250 cm	signal white	4,90
	734 15 42 250	PVC border section - punched holes - for floor coverings 10 mm.	10 mm	250 cm	manhattan grey	4,90

Aluminium-Border section bendable

	719 13 06 250	Aluminium-border section - bendable - for floor coverings 2,0 mm.	2 mm	250 cm	Alu natural	10,50
	719 13 11 250	Aluminium-border section - bendable - for floor coverings 2,0 mm.	2 mm	250 cm	silver	11,75

Schets	Artikelnummer	Omschrijving	Afmeting	Lengte	Kleur	Bruto verkoopprijs / st.
	709 13 06 250	Aluminium-border section - bendable - for floor coverings 2,5 mm.	2,5 mm	250 cm	Alu natural	10,90
	709 13 11 250	Aluminium-border section - bendable - for floor coverings 2,5 mm.	2,5 mm	250 cm	silver	12,00
	700 13 06 250	Aluminium-border section - bendable - for floor coverings 3,0 mm.	3 mm	250 cm	Alu natural	11,25
	700 13 11 250	Aluminium-border section - bendable - for floor coverings 3,0 mm.	3 mm	250 cm	silver	12,25
	701 13 06 250	Aluminium-border section - bendable - for floor coverings 4 - 4,5 mm.	4,5 mm	250 cm	Alu natural	11,50
	701 13 11 250	Aluminium-border section - bendable - for floor coverings 4 - 4,5 mm.	4,5 mm	250 cm	silver	12,65
	702 13 06 250	Aluminium-border section - bendable - for floor coverings 6 mm.	6 mm	250 cm	Alu natural	11,90
	702 13 11 250	Aluminium-border section - bendable - for floor coverings 6 mm.	6 mm	250 cm	silver	12,90
	703 13 06 250	Aluminium-border section - bendable - for floor coverings 8 mm.	8 mm	250 cm	Alu natural	12,40
	703 13 11 250	Aluminium-border section - bendable - for floor coverings 8 mm.	8 mm	250 cm	silver	13,65
	704 13 06 250	Aluminium-border section - bendable - for floor coverings 10 mm.	10 mm	250 cm	Alu natural	13,00
	704 13 11 250	Aluminium-border section - bendable - for floor coverings 10 mm.	10 mm	250 cm	silver	14,40
	705 13 06 250	Aluminium-border section - bendable - for floor coverings 12,5 mm.	12,5 mm	250 cm	Alu natural	13,90
	705 13 11 250	Aluminium-border section - bendable - for floor coverings 12,5 mm.	12,5 mm	250 cm	silver	15,25
706 13 06 250	Aluminium-border section - bendable - for floor coverings 15 mm.	15 mm	250 cm	Alu natural	14,90	
706 13 11 250	Aluminium-border section - bendable - for floor coverings 15 mm.	15 mm	250 cm	silver	16,25	
707 13 06 250	Aluminium-border section - bendable - for floor coverings 22,5 mm.	22 mm	250 cm	Alu natural	18,15	

Pure brass - Border section bendable

	710 13 02 250	Brass border section - bendable - for floor coverings 2 - 3 mm.	3 mm	250 cm	pure brass	35,00
	711 13 02 250	Brass border section - bendable - for floor coverings 4 - 4,5 mm.	4,5 mm	250 cm	pure brass	38,05
	712 13 02 250	Brass border section - bendable - for floor coverings 6 mm.	6 mm	250 cm	pure brass	41,80
	713 13 02 250	Brass border section - bendable - for floor coverings 8 mm.	8 mm	250 cm	pure brass	46,30
	714 13 02 250	Brass border section - bendable - for floor coverings 10 mm.	10 mm	250 cm	pure brass	50,55
	715 13 02 250	Brass border section - bendable - for floor coverings 12,5 mm.	12,5 mm	250 cm	pure brass	54,90
	716 13 02 250	Brass border section - bendable - for floor coverings 15 mm.	15 mm	250 cm	pure brass	59,10
	717 13 02 250	Brass border section - bendable - for floor coverings 22,5 mm.	22 mm	250 cm	pure brass	77,80

Bending machine



- > Suitable for the uniform deformation of flexible Border section No. 700 - 717 and T-Cover section No. 265 - 268.
- > Infinitely variable circle radius from 100 mm to infinity.
- > Smooth bending rolls with adaptable and adjustable gaps for various types of sections.
- > Scratch-resistant polyamide surfaces and low-wear silicon rolls mounted with ball bearings.
- > Stable rubber feet ensure safe positioning on any surface.

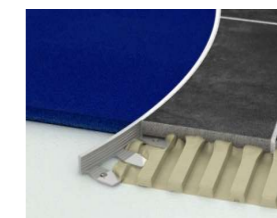





837 00 00 000	Bending Machine - R min.: 100 mm					#WAARDE!
---------------	----------------------------------	--	--	--	--	-----------------

Aluminium Quarter-Circle Trims

742 15 11 250	Aluminium Quarter-circle trims - punched holes - for floor coverings 6 mm.	6 mm	250 cm	silver matt	9,25
743 15 11 250	Aluminium Quarter-circle trims - punched holes - for floor coverings 8 mm.	8 mm	250 cm	silver matt	10,65
744 15 11 250	Aluminium Quarter-circle trims - punched holes - for floor coverings 10 mm.	10 mm	250 cm	silver matt	11,90



Schets	Artikelnummer	Omschrijving	Afmeting	Lengte	Kleur	Bruto verkoopprijs / st.
	746 15 11 250	Aluminium Quarter-circle trims - punched holes - for floor coverings 11 mm.	11 mm	250 cm	silver matt	12,50
	745 15 11 250	Aluminium Quarter-circle trims - punched holes - for floor coverings 12,5 mm.	12,5 mm	250 cm	silver matt	13,65
	742 01 11 000	Aluminium Inner corner for quarter-circle trims 6 mm -solid aluminium.	1 pc./bag		silver matt	9,45
	743 01 11 000	Aluminium Inner corner for quarter-circle trims 8 mm -solid aluminium.	1 pc./bag		silver matt	9,45
	744 01 11 000	Aluminium Inner corner for quarter-circle trims 10 mm -solid aluminium.	1 pc./bag		silver matt	9,80
	746 01 11 000	Aluminium Inner corner for quarter-circle trims 11 mm -solid aluminium.	1 pc./bag		silver matt	9,80
	745 01 11 000	Aluminium Inner corner for quarter-circle trims 12,5 mm -solid aluminium.	1 pc./bag		silver matt	9,80
	742 02 11 000	Aluminium Outer corner for quarter-circle trims 6 mm -solid aluminium.	1 pc./bag		silver matt	7,45
	743 02 11 000	Aluminium Outer corner for quarter-circle trims 8 mm -solid aluminium.	1 pc./bag		silver matt	7,45
	744 02 11 000	Aluminium Outer corner for quarter-circle trims 10 mm -solid aluminium.	1 pc./bag		silver matt	7,85
	746 02 11 000	Aluminium Outer corner for quarter-circle trims 11 mm -solid aluminium.	1 pc./bag		silver matt	7,85
	745 02 11 000	Aluminium Outer corner for quarter-circle trims 12,5 mm -solid aluminium.	1 pc./bag		silver matt	7,85
	742 03 11 000	Cast metal- Inner corner for quarter-circle trims 6 mm.	1 pc./bag		silver	3,05
	743 03 11 000	Cast metal- Inner corner for quarter-circle trims 8 mm.	1 pc./bag		silver	3,05
	744 03 11 000	Cast metal- Inner corner for quarter-circle trims 10 mm.	1 pc./bag		silver	3,20
	746 03 11 000	Cast metal- Inner corner for quarter-circle trims 11 mm.	1 pc./bag		silver	3,90
	745 03 11 000	Cast metal- Inner corner for quarter-circle trims 12,5 mm.	1 pc./bag		silver	4,30
	742 04 11 000	Cast metal- Outer corner for quarter-circle trims 6 mm.	1 pc./bag		silver	3,05
	743 04 11 000	Cast metal- Outer corner for quarter-circle trims 8 mm.	1 pc./bag		silver	3,05
	744 04 11 000	Cast metal- Outer corner for quarter-circle trims 10 mm.	1 pc./bag		silver	3,20
	746 04 11 000	Cast metal- Outer corner for quarter-circle trims 11 mm.	1 pc./bag		silver	3,90
	745 04 11 000	Cast metal- Outer corner for quarter-circle trims 12,5 mm.	1 pc./bag		silver	4,30
Stainless Steel Quarter-Circle Trims						
	752 15 01 250	Stainless steel Quarter-circle trims - punched holes - for floor coverings 6 mm.	6 mm	250 cm	stainless steel glossy	22,25
	752 15 02 250	Stainless steel Quarter-circle trims - punched holes - for floor coverings 6 mm.	6 mm	250 cm	stainless steel brushed	24,90
	753 15 01 250	Stainless steel Quarter-circle trims - punched holes - for floor coverings 8 mm.	8 mm	250 cm	stainless steel glossy	22,65
	753 15 02 250	Stainless steel Quarter-circle trims - punched holes - for floor coverings 8 mm.	8 mm	250 cm	stainless steel brushed	25,15
	754 15 01 250	Stainless steel Quarter-circle trims - punched holes - for floor coverings 10 mm.	10 mm	250 cm	stainless steel glossy	23,75
	754 15 02 250	Stainless steel Quarter-circle trims - punched holes - for floor coverings 10 mm.	10 mm	250 cm	stainless steel brushed	26,40
	756 15 01 250	Stainless steel Quarter-circle trims - punched holes - for floor coverings 11 mm.	11 mm	250 cm	stainless steel glossy	24,75
	756 15 02 250	Stainless steel Quarter-circle trims - punched holes - for floor coverings 11 mm.	11 mm	250 cm	stainless steel brushed	27,65
	755 15 01 250	Stainless steel Quarter-circle trims - punched holes - for floor coverings 12,5 mm.	12,5 mm	250 cm	stainless steel glossy	25,90

Schets	Artikelnummer	Omschrijving	Afmeting	Lengte	Kleur	Bruto verkoopprijs / st.	
	755 15 02 250	Stainless steel Quarter-circle trims - punched holes - for floor coverings 12,5 mm.	12,5 mm	250 cm	stainless steel brushed	28,00	
	752 01 01 000	Stainless steel Inner corner for quarter-circle trims 6 mm - stainless steel solid.	1 pc. / bag		stainless steel glossy	9,45	
	752 01 02 000	Stainless steel Inner corner for quarter-circle trims 6 mm - stainless steel solid.	1 pc. / bag		stainless steel brushed	12,25	
	753 01 01 000	Stainless steel Inner corner for quarter-circle trims 8 mm - stainless steel solid.	1 pc. / bag		stainless steel glossy	9,90	
	753 01 02 000	Stainless steel Inner corner for quarter-circle trims 8 mm - stainless steel solid.	1 pc. / bag		stainless steel brushed	12,80	
	754 01 01 000	Stainless steel Inner corner for quarter-circle trims 10 mm - stainless steel solid.	1 pc. / bag		stainless steel glossy	10,25	
	754 01 02 000	Stainless steel Inner corner for quarter-circle trims 10 mm - stainless steel solid.	1 pc. / bag		stainless steel brushed	13,15	
	755 01 01 000	Stainless steel Inner corner for quarter-circle trims 12,5 mm - stainless steel solid.	1 pc. / bag		stainless steel glossy	10,80	
	755 01 02 000	Stainless steel Inner corner for quarter-circle trims 12,5 mm - stainless steel solid.	1 pc. / bag		stainless steel brushed	13,85	
		752 02 01 000	Stainless steel Outer corner for quarter-circle trims 6 mm - stainless steel solid.	1 pc. / bag		stainless steel glossy	9,45
		752 02 02 000	Stainless steel Outer corner for quarter-circle trims 6 mm - stainless steel solid.	1 pc. / bag		stainless steel brushed	12,25
753 02 01 000		Stainless steel Outer corner for quarter-circle trims 8 mm - stainless steel solid.	1 pc. / bag		stainless steel glossy	9,90	
753 02 02 000		Stainless steel Outer corner for quarter-circle trims 8 mm - stainless steel solid.	1 pc. / bag		stainless steel brushed	12,80	
754 02 01 000		Stainless steel Outer corner for quarter-circle trims 10 mm - stainless steel solid.	1 pc. / bag		stainless steel glossy	10,25	
754 02 02 000		Stainless steel Outer corner for quarter-circle trims 10 mm - stainless steel solid.	1 pc. / bag		stainless steel brushed	13,15	
755 02 01 000		Stainless steel Outer corner for quarter-circle trims 12,5 mm - stainless steel solid.	1 pc. / bag		stainless steel glossy	10,80	
755 02 02 000		Stainless steel Outer corner for quarter-circle trims 12,5 mm - stainless steel solid.	1 pc. / bag		stainless steel brushed	13,85	
		753 01 11 000	Stainless steel Inner corner for quarter-circle trims 8 mm - cast metal	1 pc. / bag		stainless steel glossy	3,05
		753 01 12 000	Stainless steel Inner corner for quarter-circle trims 8 mm - cast metal	1 pc. / bag		stainless steel brushed	3,05
	754 01 11 000	Stainless steel Inner corner for quarter-circle trims 10 mm - cast metal	1 pc. / bag		stainless steel glossy	3,20	
	754 01 12 000	Stainless steel Inner corner for quarter-circle trims 10 mm - cast metal	1 pc. / bag		stainless steel brushed	3,20	
	756 01 11 000	Stainless steel Inner corner for quarter-circle trims 11 mm - cast metal	1 pc. / bag		stainless steel glossy	3,90	
	756 01 12 000	Stainless steel Inner corner for quarter-circle trims 11 mm - cast metal	1 pc. / bag		stainless steel brushed	3,90	
	755 01 11 000	Stainless steel Inner corner for quarter-circle trims 12,5 mm - cast metal	1 pc. / bag		stainless steel glossy	4,30	
	755 01 12 000	Stainless steel Inner corner for quarter-circle trims 12,5 mm - cast metal	1 pc. / bag		stainless steel brushed	4,30	
		753 02 11 000	Stainless steel Outer corner for quarter-circle trims 8 mm - cast metal	1 pc. / bag		stainless steel glossy	3,05
		753 02 12 000	Stainless steel Outer corner for quarter-circle trims 8 mm - cast metal	1 pc. / bag		stainless steel brushed	3,05
754 02 11 000		Stainless steel Outer corner for quarter-circle trims 10 mm - cast metal	1 pc. / bag		stainless steel glossy	3,20	
754 02 12 000		Stainless steel Outer corner for quarter-circle trims 10 mm - cast metal	1 pc. / bag		stainless steel brushed	3,20	
756 02 11 000		Stainless steel Outer corner for quarter-circle trims 11 mm - cast metal	1 pc. / bag		stainless steel glossy	3,90	
756 02 12 000		Stainless steel Outer corner for quarter-circle trims 11 mm - cast metal	1 pc. / bag		stainless steel brushed	3,90	
755 02 11 000		Stainless steel Outer corner for quarter-circle trims 12,5 mm - cast metal	1 pc. / bag		stainless steel glossy	4,30	
755 02 12 000		Stainless steel Outer corner for quarter-circle trims 12,5 mm - cast metal	1 pc. / bag		stainless steel brushed	4,30	
PVC Quarter-Circle Trims							
		762 15 30 250	PVC Quarter-circle trims - punched holes - for floor coverings 6 mm.	6 mm	250 cm	pure white	5,00

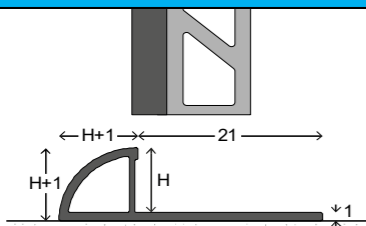
Schets	Artikelnummer	Omschrijving	Afmeting	Lengte	Kleur	Bruto verkoopprijs / st.
	762 15 34 250	PVC Quarter-circle trims - punched holes - for floor coverings 6 mm.	6 mm	250 cm	signal white	5,00
	762 15 42 250	PVC Quarter-circle trims - punched holes - for floor coverings 6 mm.	6 mm	250 cm	Manhattan grey	5,00
	763 15 30 250	PVC Quarter-circle trims - punched holes - for floor coverings 8 mm.	8 mm	250 cm	pure white	5,25
	763 15 34 250	PVC Quarter-circle trims - punched holes - for floor coverings 8 mm.	8 mm	250 cm	signal white	5,25
	763 15 42 250	PVC Quarter-circle trims - punched holes - for floor coverings 8 mm.	8 mm	250 cm	Manhattan grey	5,25
	764 15 30 250	PVC Quarter-circle trims - punched holes - for floor coverings 10 mm.	10 mm	250 cm	pure white	5,75
764 15 34 250	PVC Quarter-circle trims - punched holes - for floor coverings 10 mm.	10 mm	250 cm	signal white	5,75	
764 15 42 250	PVC Quarter-circle trims - punched holes - for floor coverings 10 mm.	10 mm	250 cm	Manhattan grey	5,75	



762 02 30 000	Outer corner for PVC quarter-circle trims 6 mm.	5 pcs. / bag		pure white	6,10
762 02 34 000	Outer corner for PVC quarter-circle trims 6 mm.	5 pcs. / bag		signal white	6,10
762 02 42 000	Outer corner for PVC quarter-circle trims 6 mm.	5 pcs. / bag		Manhattan grey	6,10
763 02 30 000	Outer corner for PVC quarter-circle trims 8 mm.	5 pcs. / bag		pure white	6,10
763 02 34 000	Outer corner for PVC quarter-circle trims 8 mm.	5 pcs. / bag		signal white	6,10
763 02 42 000	Outer corner for PVC quarter-circle trims 8 mm.	5 pcs. / bag		Manhattan grey	6,10
764 02 30 000	Outer corner for PVC quarter-circle trims 10 mm.	5 pcs. / bag		pure white	6,10
764 02 34 000	Outer corner for PVC quarter-circle trims 10 mm.	5 pcs. / bag		signal white	6,10
764 02 42 000	Outer corner for PVC quarter-circle trims 10 mm.	5 pcs. / bag		Manhattan grey	6,10

Aluminium Square Edge Trims

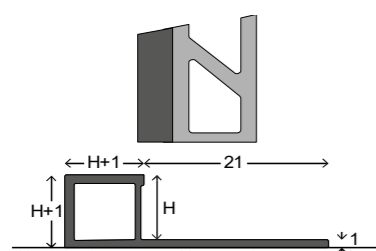

749 15 11 250	Aluminium Square edge trim - punched holes - for floor coverings 6 mm.	6 mm	250 cm	silver matt	9,90
747 15 11 250	Aluminium Square edge trim - punched holes - for floor coverings 8 mm.	8 mm	250 cm	silver matt	11,40
747 15 30 250	Aluminium Square edge trim - punched holes - for floor coverings 8 mm.	8 mm	250 cm	white powdercoated	12,90
748 15 11 250	Aluminium Square edge trim - punched holes - for floor coverings 10 mm.	10 mm	250 cm	silver	12,90
748 15 30 250	Aluminium Square edge trim - punched holes - for floor coverings 10 mm.	10 mm	250 cm	white powdercoated	14,75
750 15 11 250	Aluminium Square edge trim - punched holes - for floor coverings 11 mm.	11 mm	250 cm	silver matt	13,50
751 15 11 250	Aluminium Square edge trim - punched holes - for floor coverings 12,5 mm.	12,5 mm	250 cm	silver matt	14,50



749 03 11 000	Aluminium Corners for square edge trims 6 mm - solid aluminium.	1 pc. / bag		silver matt	7,40
747 03 11 000	Aluminium Corners for square edge trims 8 mm - solid aluminium.	1 pc. / bag		silver matt	9,35
747 03 30 000	Aluminium Corners for square edge trims 8 mm - solid aluminium.	1 pc. / bag		white powdercoated	9,35
748 03 11 000	Aluminium Corners for square edge trims 10 mm - solid aluminium.	1 pc. / bag		silver matt	10,40
748 03 30 000	Aluminium Corners for square edge trims 10 mm - solid aluminium.	1 pc. / bag		white powdercoated	10,40
750 03 11 000	Aluminium Corners for square edge trims 11 mm - solid aluminium.	1 pc. / bag		silver matt	10,80
751 03 11 000	Aluminium Corners for square edge trims 12,5 mm - solid aluminium.	1 pc. / bag		silver matt	11,30



749 04 11 000	Cast metal Corner for square edge trims 6 mm.	1 pc. / bag		silver matt	3,05
747 04 11 000	Cast metal Corner for square edge trims 8 mm.	1 pc. / bag		silver matt	3,05
747 04 30 000	Cast metal Corner for square edge trims 8 mm.	1 pc. / bag		white powdercoated	3,05
748 04 11 000	Cast metal Corner for square edge trims 10 mm.	1 pc. / bag		silver matt	3,20
748 04 30 000	Cast metal Corner for square edge trims 10 mm.	1 pc. / bag		white powdercoated	3,20

Schets	Artikelnummer	Omschrijving	Afmeting	Lengte	Kleur	Bruto verkoopprijs / st.
	750 04 11 000	Cast metal Corner for square edge trims 11 mm.	1 pc. / bag		silver matt	3,90
	751 04 11 000	Cast metal Corner for square edge trims 12,5 mm.	1 pc. / bag		silver matt	4,30

Stainless Steel Square Edge Trims

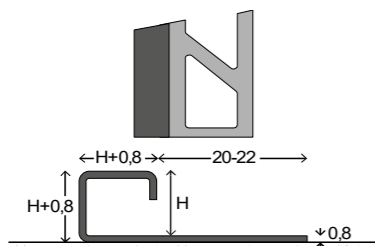

757 15 01 300	Stainless steel Square edge trims - punched holes - for floor coverings 8 mm.	8 mm	300 cm	stainless steel glossy	29,40
757 15 01 250	Stainless steel Square edge trims - punched holes - for floor coverings 8 mm.	8 mm	250 cm	stainless steel glossy	24,50
757 15 02 300	Stainless steel Square edge trims - punched holes - for floor coverings 8 mm.	8 mm	300 cm	stainless steel brushed	32,55
757 15 02 250	Stainless steel Square edge trims - punched holes - for floor coverings 8 mm.	8 mm	250 cm	stainless steel brushed	27,15
758 15 01 300	Stainless steel Square edge trims - punched holes - for floor coverings 10 mm.	10 mm	300 cm	stainless steel glossy	30,45
758 15 01 250	Stainless steel Square edge trims - punched holes - for floor coverings 10 mm.	10 mm	250 cm	stainless steel glossy	25,40
758 15 02 300	Stainless steel Square edge trims - punched holes - for floor coverings 10 mm.	10 mm	300 cm	stainless steel brushed	33,00
758 15 02 250	Stainless steel Square edge trims - punched holes - for floor coverings 10 mm.	10 mm	250 cm	stainless steel brushed	27,50
760 15 01 300	Stainless steel Square edge trims - punched holes - for floor coverings 11 mm.	11 mm	300 cm	stainless steel glossy	31,65
760 15 01 250	Stainless steel Square edge trims - punched holes - for floor coverings 11 mm.	11 mm	250 cm	stainless steel glossy	26,40
760 15 02 300	Stainless steel Square edge trims - punched holes - for floor coverings 11 mm.	11 mm	300 cm	stainless steel brushed	33,60
760 15 02 250	Stainless steel Square edge trims - punched holes - for floor coverings 11 mm.	11 mm	250 cm	stainless steel brushed	28,00
759 15 01 300	Stainless steel Square edge trims - punched holes - for floor coverings 12,5 mm.	12,5 mm	300 cm	stainless steel glossy	34,35
759 15 01 250	Stainless steel Square edge trims - punched holes - for floor coverings 12,5 mm.	12,5 mm	250 cm	stainless steel glossy	28,65
759 15 02 300	Stainless steel Square edge trims - punched holes - for floor coverings 12,5 mm.	12,5 mm	300 cm	stainless steel brushed	36,90
759 15 02 250	Stainless steel Square edge trims - punched holes - for floor coverings 12,5 mm.	12,5 mm	250 cm	stainless steel brushed	30,75



757 03 01 000	Stainless steel Corner for square edge trims 8 mm - stainless steel solid.	1 pc. / bag		stainless steel glossy	11,85
757 03 02 000	Stainless steel Corner for square edge trims 8 mm - stainless steel solid.	1 pc. / bag		stainless steel brushed	14,75
758 03 01 000	Stainless steel Corner for square edge trims 10 mm - stainless steel solid.	1 pc. / bag		stainless steel glossy	11,85
758 03 02 000	Stainless steel Corner for square edge trims 10 mm - stainless steel solid.	1 pc. / bag		stainless steel brushed	14,75
759 03 01 000	Stainless steel Corner for square edge trims 12,5 mm - stainless steel solid.	1 pc. / bag		stainless steel glossy	11,85
759 03 02 000	Stainless steel Corner for square edge trims 12,5 mm - stainless steel solid.	1 pc. / bag		stainless steel brushed	14,75



757 03 11 000	Cast metal Corner for square edge trims 8 mm.	1 pc. / bag		stainless steel glossy	3,05
757 03 12 000	Cast metal Corner for square edge trims 8 mm.	1 pc. / bag		stainless steel brushed	3,05
758 03 11 000	Cast metal Corner for square edge trims 10 mm.	1 pc. / bag		stainless steel glossy	3,20
758 03 12 000	Cast metal Corner for square edge trims 10 mm.	1 pc. / bag		stainless steel brushed	3,20
760 03 11 000	Cast metal Corner for square edge trims 11 mm.	1 pc. / bag		stainless steel glossy	3,90
760 03 12 000	Cast metal Corner for square edge trims 11 mm.	1 pc. / bag		stainless steel brushed	3,90
759 03 11 000	Cast metal Corner for square edge trims 12,5 mm.	1 pc. / bag		stainless steel glossy	4,30
759 03 12 000	Cast metal Corner for square edge trims 12,5 mm.	1 pc. / bag		stainless steel brushed	4,30

DilaTec Expansion Joint Section 778 pre-assembled

- > Expansion joint system for flooring thicknesses from 4 to 6 mm.
- > Consisting of two aluminium base profiles and an expansion joint strip from co-extruded hard and soft PVC.
- > They absorb tension reliably from the sub-floor - without tearing or unfastening from the profile.

Schets	Artikelnummer	Omschrijving	Afmeting	Lengte	Kleur	Bruto verkoopprijs / st.
	778 10 44 250	Aluminium expansion joint system - For coverings up to 4 mm thickness.	54 x 4,8 mm	250 cm	Alu / dark grey	36,25
	778 10 41 250	Aluminium expansion joint system - For coverings up to 4 mm thickness.	54 x 4,8 mm	250 cm	Alu / beige	36,25
	778 10 32 250	Aluminium expansion joint system - For coverings up to 4 mm thickness.	54 x 4,8 mm	250 cm	Alu / black	36,25
	778 10 31 300	Aluminium expansion joint system - For coverings up to 4 mm thickness.	54 x 4,8 mm	300 cm	Alu / light grey	43,50
	778 10 44 300	Aluminium expansion joint system - For coverings up to 4 mm thickness.	54 x 4,8 mm	300 cm	Alu / dark grey	43,50
	778 10 41 300	Aluminium expansion joint system - For coverings up to 4 mm thickness.	54 x 4,8 mm	300 cm	Alu / beige	43,50
778 10 32 300	Aluminium expansion joint system - For coverings up to 4 mm thickness.	54 x 4,8 mm	300 cm	Alu / black	43,50	

	778 20 31 250	Aluminium expansion joint system - For coverings up to 6 mm thickness.	54 x 6,8 mm	250 cm	Alu / light grey	38,65
	778 20 44 250	Aluminium expansion joint system - For coverings up to 6 mm thickness.	54 x 6,8 mm	250 cm	Alu / dark grey	38,65
	778 20 41 250	Aluminium expansion joint system - For coverings up to 6 mm thickness.	54 x 6,8 mm	250 cm	Alu / beige	38,65
	778 20 32 250	Aluminium expansion joint system - For coverings up to 6 mm thickness.	54 x 6,8 mm	250 cm	Alu / black	38,65
	778 20 31 300	Aluminium expansion joint system - For coverings up to 6 mm thickness.	54 x 6,8 mm	300 cm	Alu / light grey	46,35
	778 20 44 300	Aluminium expansion joint system - For coverings up to 6 mm thickness.	54 x 6,8 mm	300 cm	Alu / dark grey	46,35
	778 20 41 300	Aluminium expansion joint system - For coverings up to 6 mm thickness.	54 x 6,8 mm	300 cm	Alu / beige	46,35
	778 20 32 300	Aluminium expansion joint system - For coverings up to 6 mm thickness.	54 x 6,8 mm	300 cm	Alu / black	46,35

DilaTec Expansion Joint Section 779 pre-assembled

- > Expansion joint system for flooring thicknesses from 4 to 6 mm.
- > Consisting of two aluminium base profiles and an expansion joint strip from co-extruded hard and soft PVC.
- > They absorb tension reliably from the sub-floor - without tearing or unfastening from the profile.

	779 10 31 300	Aluminium expansion joint system - For coverings up to 4 mm thickness.	94 x 4,8 mm	300 cm	Alu / light grey	54,45
	779 10 44 300	Aluminium expansion joint system - For coverings up to 4 mm thickness.	94 x 4,8 mm	300 cm	Alu / dark grey	54,45
	779 10 41 300	Aluminium expansion joint system - For coverings up to 4 mm thickness.	94 x 4,8 mm	300 cm	Alu / beige	54,45
	779 10 32 300	Aluminium expansion joint system - For coverings up to 4 mm thickness.	94 x 4,8 mm	300 cm	Alu / black	54,45

	779 20 31 300	Aluminium expansion joint system - For coverings up to 6 mm thickness.	94 x 6,8 mm	300 cm	Alu / light grey	57,30
	779 20 44 300	Aluminium expansion joint system - For coverings up to 6 mm thickness.	94 x 6,8 mm	300 cm	Alu / dark grey	57,30
	779 20 41 300	Aluminium expansion joint system - For coverings up to 6 mm thickness.	94 x 6,8 mm	300 cm	Alu / beige	57,30
	779 20 32 300	Aluminium expansion joint system - For coverings up to 6 mm thickness.	94 x 6,8 mm	300 cm	Alu / black	57,30

DilaTec Expansion Joint System 778/ 779 - Construction Kit

	778 15 06 250	Aluminium-expansion joint base profile - 4 mm	25 x 5 mm	250 cm	plate finish	8,90
	778 15 06 300	Aluminium-expansion joint base profile - 4 mm	25 x 5 mm	300 cm	plate finish	10,65

	779 15 06 300	Aluminium-expansion joint base profile - 4 mm - with wide base section	45 x 5 mm	300 cm	plate finish	16,05
--	---------------	--	-----------	--------	--------------	--------------

	778 00 44 250	PVC expansion joint for clipping - for thicknesses up to 4 mm.	10 x 4,8 mm	250 cm	dark grey	18,75
	778 00 41 250	PVC expansion joint for clipping - for thicknesses up to 4 mm.	10 x 4,8 mm	250 cm	beige	18,75
	778 00 32 250	PVC expansion joint for clipping - for thicknesses up to 4 mm.	10 x 4,8 mm	250 cm	black	18,75

Schets	Artikelnummer	Omschrijving	Afmeting	Lengte	Kleur	Bruto verkoopprijs / st.
	778 00 31 300	PVC expansion joint for clipping - for thicknesses up to 4 mm.	10 x 4,8 mm	300 cm	light grey	22,50
	778 00 44 300	PVC expansion joint for clipping - for thicknesses up to 4 mm.	10 x 4,8 mm	300 cm	dark grey	22,50
	778 00 41 300	PVC expansion joint for clipping - for thicknesses up to 4 mm.	10 x 4,8 mm	300 cm	beige	22,50
	778 00 32 300	PVC expansion joint for clipping - for thicknesses up to 4 mm.	10 x 4,8 mm	300 cm	black	22,50

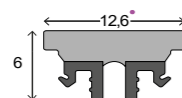

778 01 31 250	PVC expansion joint for clipping - for thicknesses up to 6 mm.	12,6 x 6,8 mm	250 cm	light grey	21,25
778 01 44 250	PVC expansion joint for clipping - for thicknesses up to 6 mm.	12,6 x 6,8 mm	250 cm	dark grey	21,25
778 01 41 250	PVC expansion joint for clipping - for thicknesses up to 6 mm.	12,6 x 6,8 mm	250 cm	beige	21,25
778 01 32 250	PVC expansion joint for clipping - for thicknesses up to 6 mm.	12,6 x 6,8 mm	250 cm	black	21,25
778 01 31 300	PVC expansion joint for clipping - for thicknesses up to 6 mm.	12,6 x 6,8 mm	300 cm	light grey	25,50
778 01 44 300	PVC expansion joint for clipping - for thicknesses up to 6 mm.	12,6 x 6,8 mm	300 cm	dark grey	25,50
778 01 41 300	PVC expansion joint for clipping - for thicknesses up to 6 mm.	12,6 x 6,8 mm	300 cm	beige	25,50
778 01 32 300	PVC expansion joint for clipping - for thicknesses up to 6 mm.	12,6 x 6,8 mm	300 cm	black	25,50

Aluminium Expansion Joint Sections

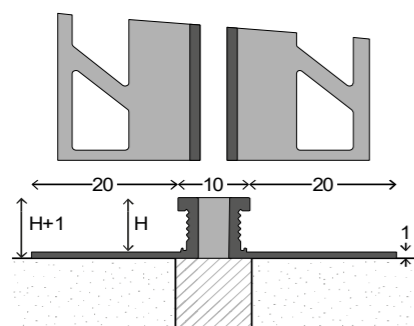

777 15 06 250	Aluminium Expansion joint section - EPDM joint - for floor coverings 2 mm.	2 mm	250 cm	alu / grey	54,65
777 15 42 300	Aluminium Expansion joint section - EPDM joint - for floor coverings 2 mm.	2 mm	300 cm	alu / grey	65,55
777 15 32 250	Aluminium Expansion joint section - EPDM joint - for floor coverings 2 mm.	2 mm	250 cm	alu / black	54,65
777 15 32 300	Aluminium Expansion joint section - EPDM joint - for floor coverings 2 mm.	2 mm	300 cm	alu / black	65,55
777 15 41 250	Aluminium Expansion joint section - EPDM joint - for floor coverings 2 mm.	2 mm	250 cm	alu / beige	54,65
777 15 41 300	Aluminium Expansion joint section - EPDM joint - for floor coverings 2 mm.	2 mm	300 cm	alu / beige	65,55

770 15 06 250	Aluminium Expansion joint section - EPDM joint - for floor coverings 3 mm.	3 mm	250 cm	alu / grey	51,75
770 15 42 300	Aluminium Expansion joint section - EPDM joint - for floor coverings 3 mm.	3 mm	300 cm	alu / grey	62,10
770 15 32 250	Aluminium Expansion joint section - EPDM joint - for floor coverings 3 mm.	3 mm	250 cm	alu / black	51,75
770 15 32 300	Aluminium Expansion joint section - EPDM joint - for floor coverings 3 mm.	3 mm	300 cm	alu / black	62,10
770 15 41 250	Aluminium Expansion joint section - EPDM joint - for floor coverings 3 mm.	3 mm	250 cm	alu / beige	51,75
770 15 41 300	Aluminium Expansion joint section - EPDM joint - for floor coverings 3 mm.	3 mm	300 cm	alu / beige	62,10

771 15 06 250	Aluminium Expansion joint section - EPDM joint - for floor coverings 4 - 4,5 mm.	4,5 mm	250 cm	alu / grey	53,40
771 15 42 300	Aluminium Expansion joint section - EPDM joint - for floor coverings 4 - 4,5 mm.	4,5 mm	300 cm	alu / grey	64,05
771 15 32 250	Aluminium Expansion joint section - EPDM joint - for floor coverings 4 - 4,5 mm.	4,5 mm	250 cm	alu / black	53,40
771 15 32 300	Aluminium Expansion joint section - EPDM joint - for floor coverings 4 - 4,5 mm.	4,5 mm	300 cm	alu / black	64,05
771 15 41 250	Aluminium Expansion joint section - EPDM joint - for floor coverings 4 - 4,5 mm.	4,5 mm	250 cm	alu / beige	53,40
771 15 41 300	Aluminium Expansion joint section - EPDM joint - for floor coverings 4 - 4,5 mm.	4,5 mm	300 cm	alu / beige	64,05

772 15 06 250	Aluminium Expansion joint section - EPDM joint - for floor coverings 6 mm.	6 mm	250 cm	alu / grey	58,00
772 15 42 300	Aluminium Expansion joint section - EPDM joint - for floor coverings 6 mm.	6 mm	300 cm	alu / grey	69,60
772 15 32 250	Aluminium Expansion joint section - EPDM joint - for floor coverings 6 mm.	6 mm	250 cm	alu / black	58,00
772 15 32 300	Aluminium Expansion joint section - EPDM joint - for floor coverings 6 mm.	6 mm	300 cm	alu / black	69,60

773 15 06 250	Aluminium Expansion joint section - EPDM joint - for floor coverings 8 mm.	8 mm	250 cm	alu / grey	62,25
---------------	--	------	--------	------------	--------------

774 15 06 250	Aluminium Expansion joint section - EPDM joint - for floor coverings 10 mm.	10 mm	250 cm	alu / grey	65,25
---------------	---	-------	--------	------------	--------------

775 15 06 250	Aluminium Expansion joint section - EPDM joint - for floor coverings 12,5 mm.	12,5 mm	250 cm	alu / grey	67,90
---------------	---	---------	--------	------------	--------------

776 15 06 250	Aluminium Expansion joint section - EPDM joint - for floor coverings 15 mm.	15 mm	250 cm	alu / grey	73,00
---------------	---	-------	--------	------------	--------------

769 25 42 250	Aluminium Expansion joint section with silicone joint - for floor coverings 2,5 mm.	2,5 mm	250 cm	grey	34,65
---------------	---	--------	--------	------	--------------

Schets	Artikelnummer	Omschrijving	Afmeting	Lengte	Kleur	Bruto verkoopprijs / st.
	769 25 32 300	Aluminium Expansion joint section with silicone joint - for floor coverings 2,5 mm.	2,5 mm	300 cm	black	41,55
	769 25 41 300	Aluminium Expansion joint section with silicone joint - for floor coverings 2,5 mm.	2,5 mm	300 cm	beige	41,55
	769 25 42 300	Aluminium Expansion joint section with silicone joint - for floor coverings 2,5 mm.	2,5 mm	300 cm	grey	41,55
	769 25 43 300	Aluminium Expansion joint section with silicone joint - for floor coverings 2,5 mm.	2,5 mm	300 cm	grey-beige	41,55
	769 25 44 300	Aluminium Expansion joint section with silicone joint - for floor coverings 2,5 mm.	2,5 mm	300 cm	anthracite	41,55
	769 25 45 300	Aluminium Expansion joint section with silicone joint - for floor coverings 2,5 mm.	2,5 mm	300 cm	silvergrey	41,55
	769 25 46 300	Aluminium Expansion joint section with silicone joint - for floor coverings 2,5 mm.	2,5 mm	300 cm	honey oak	41,55
	769 25 47 300	Aluminium Expansion joint section with silicone joint - for floor coverings 2,5 mm.	2,5 mm	300 cm	fawn brown	41,55
	769 25 48 300	Aluminium Expansion joint section with silicone joint - for floor coverings 2,5 mm.	2,5 mm	300 cm	caramel	41,55

770 25 32 300	Aluminium Expansion joint section with silicone joint - for floor coverings 3,0 mm.	3 mm	300 cm	black	39,45
770 25 41 300	Aluminium Expansion joint section with silicone joint - for floor coverings 3,0 mm.	3 mm	300 cm	beige	39,45
770 25 42 300	Aluminium Expansion joint section with silicone joint - for floor coverings 3,0 mm.	3 mm	300 cm	grey	39,45
770 25 43 300	Aluminium Expansion joint section with silicone joint - for floor coverings 3,0 mm.	3 mm	300 cm	grey-beige	39,45
770 25 44 300	Aluminium Expansion joint section with silicone joint - for floor coverings 3,0 mm.	3 mm	300 cm	anthracite	39,45
770 25 45 300	Aluminium Expansion joint section with silicone joint - for floor coverings 3,0 mm.	3 mm	300 cm	silvergrey	39,45
770 25 46 300	Aluminium Expansion joint section with silicone joint - for floor coverings 3,0 mm.	3 mm	300 cm	honey oak	39,45
770 25 47 300	Aluminium Expansion joint section with silicone joint - for floor coverings 3,0 mm.	3 mm	300 cm	fawn brown	39,45
770 25 48 300	Aluminium Expansion joint section with silicone joint - for floor coverings 3,0 mm.	3 mm	300 cm	caramel	39,45

771 25 32 300	Aluminium Expansion joint section with silicone joint - for floor coverings 4,5 mm.	4,5 mm	300 cm	black	40,65
771 25 41 300	Aluminium Expansion joint section with silicone joint - for floor coverings 4,5 mm.	4,5 mm	300 cm	beige	40,65
771 25 42 300	Aluminium Expansion joint section with silicone joint - for floor coverings 4,5 mm.	4,5 mm	300 cm	grey	40,65
771 25 43 300	Aluminium Expansion joint section with silicone joint - for floor coverings 4,5 mm.	4,5 mm	300 cm	grey-beige	40,65
771 25 44 300	Aluminium Expansion joint section with silicone joint - for floor coverings 4,5 mm.	4,5 mm	300 cm	anthracite	40,65
771 25 45 300	Aluminium Expansion joint section with silicone joint - for floor coverings 4,5 mm.	4,5 mm	300 cm	silvergrey	40,65
771 25 46 300	Aluminium Expansion joint section with silicone joint - for floor coverings 4,5 mm.	4,5 mm	300 cm	honey oak	40,65
771 25 47 300	Aluminium Expansion joint section with silicone joint - for floor coverings 4,5 mm.	4,5 mm	300 cm	fawn brown	40,65
771 25 48 300	Aluminium Expansion joint section with silicone joint - for floor coverings 4,5 mm.	4,5 mm	300 cm	caramel	40,65

Edelstahl-Dehnfugenprofile

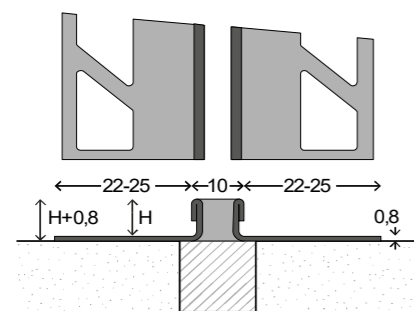

780 15 01 250	Stainless steel Expansion joint section - EPDM joint - for floor coverings 2 - 3 mm.	3 mm	250 cm	stainless steel / grey	81,15
780 15 01 300	Stainless steel Expansion joint section - EPDM joint - for floor coverings 2 - 3 mm.	3 mm	300 cm	stainless steel / grey	97,35
780 15 02 250	Stainless steel Expansion joint section - EPDM joint - for floor coverings 2 - 3 mm.	3 mm	250 cm	stainless steel / black	81,15
780 15 02 300	Stainless steel Expansion joint section - EPDM joint - for floor coverings 2 - 3 mm.	3 mm	300 cm	stainless steel / black	97,35
780 15 41 300	Stainless steel Expansion joint section - EPDM joint - for floor coverings 2 - 3 mm.	3 mm	300 cm	stainless steel / beige	97,35

781 15 01 250	Stainless steel Expansion joint section - EPDM joint - for floor coverings 4 - 4,5 mm.	4,5 mm	250 cm	stainless steel / grey	81,90
781 15 01 300	Stainless steel Expansion joint section - EPDM joint - for floor coverings 4 - 4,5 mm.	4,5 mm	300 cm	stainless steel / grey	98,25
781 15 02 250	Stainless steel Expansion joint section - EPDM joint - for floor coverings 4 - 4,5 mm.	4,5 mm	250 cm	stainless steel / black	81,90
781 15 02 300	Stainless steel Expansion joint section - EPDM joint - for floor coverings 4 - 4,5 mm.	4,5 mm	300 cm	stainless steel / black	98,25
781 15 41 300	Stainless steel Expansion joint section - EPDM joint - for floor coverings 4 - 4,5 mm.	4,5 mm	300 cm	stainless steel / beige	98,25

782 15 01 250	Stainless steel Expansion joint section - EPDM joint - for floor coverings 6 mm.	6 mm	250 cm	stainless steel / grey	84,15
782 15 01 300	Stainless steel Expansion joint section - EPDM joint - for floor coverings 6 mm.	6 mm	300 cm	stainless steel / grey	100,95
782 15 02 250	Stainless steel Expansion joint section - EPDM joint - for floor coverings 6 mm.	6 mm	250 cm	stainless steel / black	84,15
782 15 02 300	Stainless steel Expansion joint section - EPDM joint - for floor coverings 6 mm.	6 mm	300 cm	stainless steel / black	100,95

783 15 01 250	Stainless steel Expansion joint section - EPDM joint - for floor coverings 8 mm.	8 mm	250 cm	stainless steel / grey	89,40
---------------	--	------	--------	------------------------	--------------

784 15 01 250	Stainless steel Expansion joint section - EPDM joint - for floor coverings 10 mm.	10 mm	250 cm	stainless steel / grey	100,00
---------------	---	-------	--------	------------------------	---------------

Schets	Artikelnummer	Omschrijving	Afmeting	Lengte	Kleur	Bruto verkoopprijs / st.
--------	---------------	--------------	----------	--------	-------	--------------------------

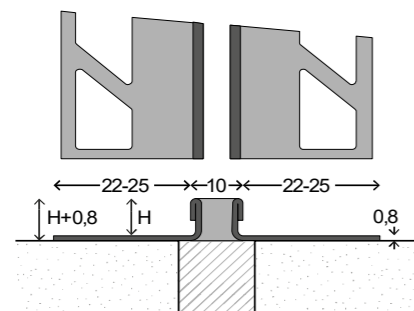

785 25 32 300	Stainless steel Expansion joint section - with silicone joint - for floor coverings 2 - 2,5 mm	2,5 mm	300 cm	schwarz	70,65
785 25 42 300	Stainless steel Expansion joint section - with silicone joint - for floor coverings 2 - 2,5 mm	2,5 mm	300 cm	grau	70,65
785 25 44 300	Stainless steel Expansion joint section - with silicone joint - for floor coverings 2 - 2,5 mm	2,5 mm	300 cm	anthrazit	70,65

780 25 32 300	Stainless steel Expansion joint section - with silicone joint - for floor coverings 3 mm.	3 mm	300 cm	black	70,65
780 25 41 300	Stainless steel Expansion joint section - with silicone joint - for floor coverings 3 mm.	3 mm	300 cm	beige	70,65
780 25 42 300	Stainless steel Expansion joint section - with silicone joint - for floor coverings 3 mm.	3 mm	300 cm	grey	70,65
780 25 43 300	Stainless steel Expansion joint section - with silicone joint - for floor coverings 3 mm.	3 mm	300 cm	grey-beige	70,65
780 25 44 300	Stainless steel Expansion joint section - with silicone joint - for floor coverings 3 mm.	3 mm	300 cm	anthracite	70,65
780 25 45 300	Stainless steel Expansion joint section - with silicone joint - for floor coverings 3 mm.	3 mm	300 cm	silvergry	70,65
780 25 46 300	Stainless steel Expansion joint section - with silicone joint - for floor coverings 3 mm.	3 mm	300 cm	honey oak	70,65
780 25 47 300	Stainless steel Expansion joint section - with silicone joint - for floor coverings 3 mm.	3 mm	300 cm	fawn brown	70,65
780 25 48 300	Stainless steel Expansion joint section - with silicone joint - for floor coverings 3 mm.	3 mm	300 cm	caramel	70,65

781 25 32 300	Stainless steel Expansion joint section - with silicone joint - for floor coverings 4,5 mm.	4,5 mm	300 cm	black	72,75
781 25 41 300	Stainless steel Expansion joint section - with silicone joint - for floor coverings 4,5 mm.	4,5 mm	300 cm	beige	72,75
781 25 42 300	Stainless steel Expansion joint section - with silicone joint - for floor coverings 4,5 mm.	4,5 mm	300 cm	grey	72,75
781 25 43 300	Stainless steel Expansion joint section - with silicone joint - for floor coverings 4,5 mm.	4,5 mm	300 cm	grey-beige	72,75
781 25 44 300	Stainless steel Expansion joint section - with silicone joint - for floor coverings 4,5 mm.	4,5 mm	300 cm	anthracite	72,75
781 25 45 300	Stainless steel Expansion joint section - with silicone joint - for floor coverings 4,5 mm.	4,5 mm	300 cm	silvergry	72,75
781 25 46 300	Stainless steel Expansion joint section - with silicone joint - for floor coverings 4,5 mm.	4,5 mm	300 cm	honey oak	72,75
781 25 47 300	Stainless steel Expansion joint section - with silicone joint - for floor coverings 4,5 mm.	4,5 mm	300 cm	fawn brown	72,75
781 25 48 300	Stainless steel Expansion joint section - with silicone joint - for floor coverings 4,5 mm.	4,5 mm	300 cm	caramel	72,75

Stair Nosings for Tiles

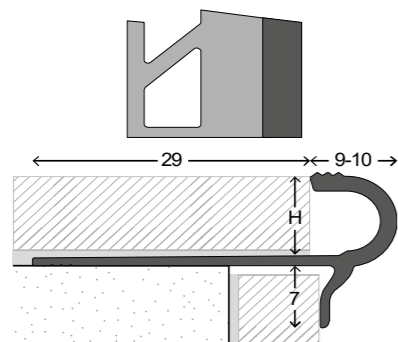

788 15 11 250	Aluminium Stair nosing for ceramic tiles - 8 mm.	8 mm	250 cm	silver	16,65
788 15 11 100	Aluminium Stair nosing for ceramic tiles - 8 mm.	8 mm	100 cm	silver	7,00

789 15 11 250	Aluminium Stair nosing for ceramic tiles - 10 mm.	10 mm	250 cm	silver	17,75
789 15 11 100	Aluminium Stair nosing for ceramic tiles - 10 mm.	10 mm	100 cm	silver	7,45

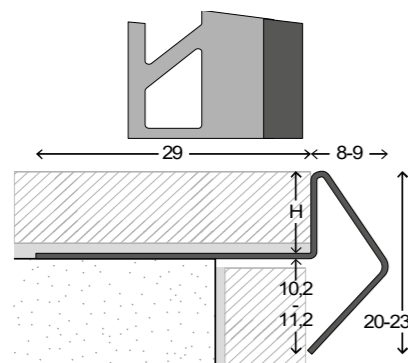

791 15 01 250	Stainless steel Stair nosing - punched holes - for floor coverings 8 mm.	8 mm	250 cm	stainless steel glossy	33,25
791 15 02 250	Stainless steel Stair nosing - punched holes - for floor coverings 8 mm.	8 mm	250 cm	stainless steel brushed	34,40

792 15 01 250	Stainless steel Stair nosing - punched holes - for floor coverings 10 mm.	10 mm	250 cm	stainless steel glossy	35,65
792 15 02 250	Stainless steel Stair nosing - punched holes - for floor coverings 10 mm.	10 mm	250 cm	stainless steel brushed	36,75

Angle Edges

278 24 11 270	Aluminium-angle edge - auto-adhesive	15 x 6,5 mm	270 cm S	silver	15,00
---------------	--------------------------------------	-------------	----------	--------	--------------

Schets	Artikelnummer	Omschrijving	Afmeting	Lengte	Kleur	Bruto verkoopprijs / st.
	278 24 14 270	Aluminium-angle edge - auto-adhesive	15 x 6,5 mm	270 cm S	stainless steel matt	16,65
	278 14 32 300	Aluminium-angle edge - auto-adhesive	15 x 6,5 mm	300 cm S	black powd. (RAL 9005)	19,65
	278 14 32 100	Aluminium-angle edge - auto-adhesive	15 x 6,5 mm	100 cm S	black powd. (RAL 9005)	7,15
	277 20 11 270	Aluminium-angle edge - without holes	15 x 15 mm	270 cm	silver	13,65
	277 24 11 270	Aluminium-angle edge - auto-adhesive	15 x 15 mm	270 cm S	silver	17,70
	277 24 14 270	Aluminium-angle edge - auto-adhesive	15 x 15 mm	270 cm S	stainless steel matt	19,85
	277 24 32 270	Aluminium-angle edge - auto-adhesive	15 x 15 mm	270 cm S	black powd. (RAL 9005)	21,90
	291 20 11 270	Aluminium-angle edge - without holes	15 x 8,5 mm	270 cm	silver	12,70
	291 24 13 270	Aluminium-angle edge - auto-adhesive	15 x 8,5 mm	270 cm S	sahara	19,20
	291 24 11 270	Aluminium-angle edge - auto-adhesive	15 x 8,5 mm	270 cm S	silver	18,10
	291 24 14 270	Aluminium-angle edge - auto-adhesive	15 x 8,5 mm	270 cm S	stainless steel matt	20,80
	292 20 11 270	Aluminium-angle edge - without holes	20 x 10 mm	270 cm	silver	13,25
	292 24 13 270	Aluminium-angle edge - auto-adhesive	20 x 10 mm	270 cm S	sahara	20,00
	292 24 11 270	Aluminium-angle edge - auto-adhesive	20 x 10 mm	270 cm S	silver	18,90
	292 24 14 270	Aluminium-angle edge - auto-adhesive	20 x 10 mm	270 cm S	stainless steel matt	21,75
	160 10 11 500	Aluminium-angle edge - without holes	24,5 x 10 mm	500 cm	silver	Op aanvraag
	160 10 11 250	Aluminium-angle edge - without holes	24,5 x 10 mm	250 cm	silver	12,00
	160 23 10 270	Aluminium-angle edge - countersunk holes	24,5 x 10 mm	270 cm	gold	14,35
	160 23 10 270 SB	Aluminium-angle edge - countersunk holes incl. screws and dowels	24,5 x 10 mm	270 cm SB	gold	17,05
	160 13 10 100	Aluminium-angle edge - countersunk holes	24,5 x 10 mm	100 cm SB	gold	6,40
	160 23 13 270	Aluminium-angle edge - countersunk holes	24,5 x 10 mm	270 cm	sahara	14,35
	160 23 13 270 SB	Aluminium-angle edge - countersunk holes incl. screws and dowels	24,5 x 10 mm	270 cm SB	sahara	17,05
	160 13 13 100	Aluminium-angle edge - countersunk holes	24,5 x 10 mm	100 cm SB	sahara	6,40

Schets	Artikelnummer	Omschrijving	Afmeting	Lengte	Kleur	Bruto verkoopprijs / st.
	160 13 11 500	Aluminium-angle edge - countersunk holes	24,5 x 10 mm	500 cm	silver	Op aanvraag
	160 13 11 300	Aluminium-angle edge - countersunk holes	24,5 x 10 mm	300 cm	silver	15,15
	160 23 11 270	Aluminium-angle edge - countersunk holes	24,5 x 10 mm	270 cm	silver	13,65
	160 23 11 270 SB	Aluminium-angle edge - countersunk holes incl. screws and dowels	24,5 x 10 mm	270 cm SB	silver	16,50
	160 13 11 100	Aluminium-angle edge - countersunk holes	24,5 x 10 mm	100 cm SB	silver	6,05
	160 23 12 270	Aluminium-angle edge - countersunk holes	24,5 x 10 mm	270 cm	bronze	15,40
	160 23 12 270 SB	Aluminium-angle edge - countersunk holes incl. screws and dowels	24,5 x 10 mm	270 cm SB	bronze	18,10
	160 13 12 100	Aluminium-angle edge - countersunk holes	24,5 x 10 mm	100 cm SB	bronze	6,70
	160 23 14 270	Aluminium-angle edge - countersunk holes	24,5 x 10 mm	270 cm	stainless steel matt	15,40
	160 23 14 270 SB	Aluminium-angle edge - countersunk holes incl. screws and dowels	24,5 x 10 mm	270 cm SB	stainless steel matt	18,10
	160 13 14 100	Aluminium-angle edge - countersunk holes	24,5 x 10 mm	100 cm SB	stainless steel matt	6,70
	160 23 19 270	Aluminium-angle edge - countersunk holes incl. screws and dowels	24,5 x 10 mm	270 cm SB	stainless steel brushed	20,15
	160 13 19 100	Aluminium-angle edge - countersunk holes	24,5 x 10 mm	100 cm SB	stainless steel brushed	8,10
	160 24 10 270	Aluminium-angle edge - auto-adhesive	24,5 x 10 mm	270 cm S	gold	17,55
	160 14 10 100	Aluminium-angle edge - auto-adhesive	24,5 x 10 mm	100 cm SB	gold	7,00
	160 24 10 090	Aluminium-angle edge - auto-adhesive	24,5 x 10 mm	90 cm SB	gold	6,40
	160 14 13 300	Aluminium-angle edge - auto-adhesive	24,5 x 10 mm	300 cm S	sahara	19,50
	160 24 13 270	Aluminium-angle edge - auto-adhesive	24,5 x 10 mm	270 cm S	sahara	17,55
	160 14 13 100	Aluminium-angle edge - auto-adhesive	24,5 x 10 mm	100 cm SB	sahara	7,00
	160 24 13 090	Aluminium-angle edge - auto-adhesive	24,5 x 10 mm	90 cm SB	sahara	6,40
	160 14 11 300	Aluminium-angle edge - auto-adhesive	24,5 x 10 mm	300 cm S	silver	18,45
	160 24 11 270	Aluminium-angle edge - auto-adhesive	24,5 x 10 mm	270 cm S	silver	16,65
	160 14 11 100	Aluminium-angle edge - auto-adhesive	24,5 x 10 mm	100 cm SB	silver	6,70
	160 24 11 090	Aluminium-angle edge - auto-adhesive	24,5 x 10 mm	90 cm SB	silver	6,15
	160 14 12 300	Aluminium-angle edge - auto-adhesive	24,5 x 10 mm	300 cm S	bronze	20,25
	160 24 12 270	Aluminium-angle edge - auto-adhesive	24,5 x 10 mm	270 cm S	bronze	18,25
	160 14 12 100	Aluminium-angle edge - auto-adhesive	24,5 x 10 mm	100 cm SB	bronze	7,35
	160 24 12 090	Aluminium-angle edge - auto-adhesive	24,5 x 10 mm	90 cm SB	bronze	6,85
	160 14 14 300	Aluminium-angle edge - auto-adhesive	24,5 x 10 mm	300 cm S	stainless steel matt	20,25
	160 24 14 270	Aluminium-angle edge - auto-adhesive	24,5 x 10 mm	270 cm S	stainless steel matt	18,25
	160 14 14 100	Aluminium-angle edge - auto-adhesive	24,5 x 10 mm	100 cm SB	stainless steel matt	7,35
	160 24 14 090	Aluminium-angle edge - auto-adhesive	24,5 x 10 mm	90 cm SB	stainless steel matt	6,85
	160 24 19 270	Aluminium-angle edge - auto-adhesive	24,5 x 10 mm	270 cm S	stainless steel brushed	20,70
160 14 19 100	Aluminium-angle edge - auto-adhesive	24,5 x 10 mm	100 cm SB	stainless steel brushed	8,40	
	160 14 32 300	Aluminium-angle edge - auto-adhesive	24,5 x 10 mm	300 cm S	black powd. (RAL 9005)	20,40
	160 14 32 100	Aluminium-angle edge - auto-adhesive	24,5 x 10 mm	100 cm SB	black powd. (RAL 9005)	7,45
	160 14 50 100	Aluminium-angle edge - auto-adhesive	24,5 x 10 mm	100 cm SB	metallic anthracite	9,25
	160 14 52 100	Aluminium-angle edge - auto-adhesive	24,5 x 10 mm	100 cm SB	metallic grey	9,25
	160 14 53 100	Aluminium-angle edge - auto-adhesive	24,5 x 10 mm	100 cm SB	metallic bronze	9,25
	160 44 20 270	Aluminium-angle edge - auto-adhesive	24,5 x 10 mm	270 cm S	beech	23,25
	160 44 20 090	Aluminium-angle edge - auto-adhesive	24,5 x 10 mm	90 cm SB	beech	8,45
	160 44 21 270	Aluminium-angle edge - auto-adhesive	24,5 x 10 mm	270 cm S	dark oak	23,25
	160 44 21 090	Aluminium-angle edge - auto-adhesive	24,5 x 10 mm	90 cm SB	dark oak	8,45
	160 44 25 270	Aluminium-angle edge - auto-adhesive	24,5 x 10 mm	270 cm S	light oak	23,25
160 44 25 090	Aluminium-angle edge - auto-adhesive	24,5 x 10 mm	90 cm SB	light oak	8,45	
160 44 22 270	Aluminium-angle edge - auto-adhesive	24,5 x 10 mm	270 cm S	maple	23,25	
160 44 22 090	Aluminium-angle edge - auto-adhesive	24,5 x 10 mm	90 cm SB	maple	8,45	
160 44 24 270	Aluminium-angle edge - auto-adhesive	24,5 x 10 mm	270 cm S	walnut	23,25	

Schets	Artikelnummer	Omschrijving	Afmeting	Lengte	Kleur	Bruto verkoopprijs / st.
	160 44 24 090	Aluminium-angle edge - auto-adhesive	24,5 x 10 mm	90 cm SB	walnut	8,45
	160 44 27 270	Aluminium-angle edge - auto-adhesive	24,5 x 10 mm	270 cm S	light grey oak	23,25
	160 44 27 090	Aluminium-angle edge - auto-adhesive	24,5 x 10 mm	90 cm SB	light grey oak	8,45
	160 44 28 270	Aluminium-angle edge - auto-adhesive	24,5 x 10 mm	270 cm S	grey oak	23,25
	160 44 28 090	Aluminium-angle edge - auto-adhesive	24,5 x 10 mm	90 cm SB	grey oak	8,45
	161 13 11 300	Aluminium-angle edge - bendable on request with screw holes	24,5 x 15 mm	300 cm	silver	16,50

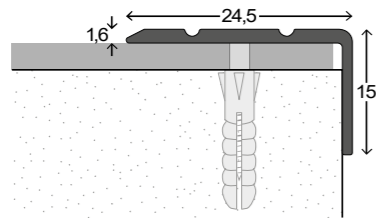

	161 24 10 270	Aluminium-angle edge - auto-adhesive	24,5 x 15 mm	270 cm S	gold	19,60
	161 24 10 090	Aluminium-angle edge - auto-adhesive	24,5 x 15 mm	90 cm SB	gold	7,25
	161 14 11 300	Aluminium-angle edge - auto-adhesive	24,5 x 15 mm	300 cm S	silver	20,70
	161 24 11 270	Aluminium-angle edge - auto-adhesive	24,5 x 15 mm	270 cm S	silver	18,65
	161 14 11 100	Aluminium-angle edge - auto-adhesive	24,5 x 15 mm	100 cm SB	silver	7,05
	161 24 11 090	Aluminium-angle edge - auto-adhesive	24,5 x 15 mm	90 cm SB	silver	6,80
	161 14 14 300	Aluminium-angle edge - auto-adhesive	24,5 x 15 mm	300 cm S	stainless steel matt	22,50
	161 24 14 270	Aluminium-angle edge - auto-adhesive	24,5 x 15 mm	270 cm S	stainless steel matt	20,25
	161 14 14 100	Aluminium-angle edge - auto-adhesive	24,5 x 15 mm	100 cm SB	stainless steel matt	7,75

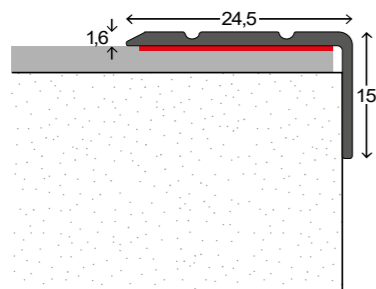

	161 14 32 300	Aluminium-angle edge - auto-adhesive	24,5 x 15 mm	300 cm S	black powd. (RAL 9005)	22,05
--	---------------	--------------------------------------	--------------	----------	------------------------	-------

	162 10 11 500	Aluminium-angle edge - without holes	24,5 x 20 mm	500 cm	silver	Op aanvraag
	162 10 11 250	Aluminium-angle edge - without holes	24,5 x 20 mm	250 cm	silver	13,75

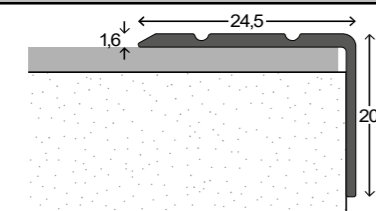

	162 23 10 270	Aluminium Angle edge - countersunk holes	24,5 x 20 mm	270 cm	gold	16,65
	162 23 10 270 SB	Aluminium Angle edge - countersunk holes - incl. screws and plugs	24,5 x 20 mm	270 cm SB	gold	19,45
	162 13 10 100	Aluminium Angle edge - countersunk holes	24,5 x 20 mm	100 cm SB	gold	7,20
	162 23 13 270	Aluminium Angle edge - countersunk holes	24,5 x 20 mm	270 cm	sahara	16,65
	162 23 13 270 SB	Aluminium Angle edge - countersunk holes - incl. screws and plugs	24,5 x 20 mm	270 cm SB	sahara	19,45
	162 13 13 100	Aluminium Angle edge - countersunk holes	24,5 x 20 mm	100 cm SB	sahara	7,20
	162 13 11 500	Aluminium Angle edge - countersunk holes	24,5 x 20 mm	500 cm	silver	Op aanvraag
	162 13 11 300	Aluminium Angle edge - countersunk holes	24,5 x 20 mm	300 cm	silver	17,25
	162 23 11 270	Aluminium Angle edge - countersunk holes	24,5 x 20 mm	270 cm	silver	15,55
	162 23 11 270 SB	Aluminium Angle edge - countersunk holes - incl. screws and plugs	24,5 x 20 mm	270 cm SB	silver	18,40
	162 13 11 100	Aluminium Angle edge - countersunk holes	24,5 x 20 mm	100 cm SB	silver	6,80
	162 23 11 090	Aluminium Angle edge - countersunk holes	24,5 x 20 mm	90 cm SB	silver	6,25
	162 23 12 270	Aluminium Angle edge - countersunk holes	24,5 x 20 mm	270 cm	bronze	17,15
	162 23 12 270 SB	Aluminium Angle edge - countersunk holes - incl. screws and plugs	24,5 x 20 mm	270 cm SB	bronze	20,00
	162 13 12 100	Aluminium Angle edge - countersunk holes	24,5 x 20 mm	100 cm SB	bronze	7,50
	162 23 14 270	Aluminium Angle edge - countersunk holes	24,5 x 20 mm	270 cm	stainless steel matt	17,15
	162 23 14 270 SB	Aluminium Angle edge - countersunk holes - incl. screws and plugs	24,5 x 20 mm	270 cm SB	stainless steel matt	20,00
	162 13 14 100	Aluminium Angle edge - countersunk holes	24,5 x 20 mm	100 cm SB	stainless steel matt	7,50
	162 23 19 270	Aluminium Angle edge - countersunk holes - incl. screws and plugs	24,5 x 20 mm	270 cm SB	stainless steel brushed	22,45

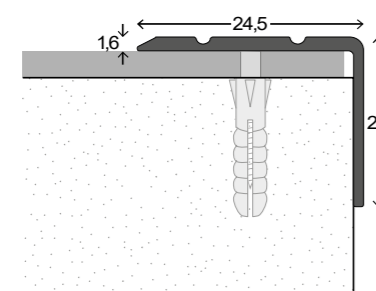

Schets	Artikelnummer	Omschrijving	Afmeting	Lengte	Kleur	Bruto verkoopprijs / st.
	162 13 19 100	Aluminium Angle edge - countersunk holes	24,5 x 20 mm	100 cm SB	stainless steel brushed	8,80
	162 24 10 270	Aluminium Angle edge - auto-adhesive	24,5 x 20 mm	270 cm S	gold	19,85
	162 14 10 100	Aluminium Angle edge - auto-adhesive	24,5 x 20 mm	100 cm SB	gold	7,75
	162 24 10 090	Aluminium Angle edge - auto-adhesive	24,5 x 20 mm	90 cm SB	gold	7,10
	162 24 13 270	Aluminium Angle edge - auto-adhesive	24,5 x 20 mm	270 cm S	sahara	19,85
	162 14 13 100	Aluminium Angle edge - auto-adhesive	24,5 x 20 mm	100 cm SB	sahara	7,75
	162 24 13 090	Aluminium Angle edge - auto-adhesive	24,5 x 20 mm	90 cm SB	sahara	7,10
	162 14 11 300	Aluminium Angle edge - auto-adhesive	24,5 x 20 mm	300 cm S	silver	20,70
	162 24 11 270	Aluminium Angle edge - auto-adhesive	24,5 x 20 mm	270 cm S	silver	18,65
	162 14 11 100	Aluminium Angle edge - auto-adhesive	24,5 x 20 mm	100 cm SB	silver	7,25
	162 24 11 090	Aluminium Angle edge - auto-adhesive	24,5 x 20 mm	90 cm SB	silver	6,65
	162 14 12 300	Aluminium Angle edge - auto-adhesive	24,5 x 20 mm	300 cm S	bronze	22,20
	162 24 12 270	Aluminium Angle edge - auto-adhesive	24,5 x 20 mm	270 cm S	bronze	20,00
	162 14 12 100	Aluminium Angle edge - auto-adhesive	24,5 x 20 mm	100 cm SB	bronze	8,15
	162 24 12 090	Aluminium Angle edge - auto-adhesive	24,5 x 20 mm	90 cm SB	bronze	7,35
	162 14 14 300	Aluminium Angle edge - auto-adhesive	24,5 x 20 mm	300 cm S	stainless steel matt	22,20
	162 24 14 270	Aluminium Angle edge - auto-adhesive	24,5 x 20 mm	270 cm S	stainless steel matt	20,00
	162 14 14 100	Aluminium Angle edge - auto-adhesive	24,5 x 20 mm	100 cm SB	stainless steel matt	8,15
	162 24 14 090	Aluminium Angle edge - auto-adhesive	24,5 x 20 mm	90 cm SB	stainless steel matt	7,35
162 24 19 270	Aluminium Angle edge - auto-adhesive	24,5 x 20 mm	270 cm S	stainless steel brushed	24,05	
162 14 19 100	Aluminium Angle edge - auto-adhesive	24,5 x 20 mm	100 cm SB	stainless steel brushed	9,75	
	162 14 32 300	Aluminium Angle edge - auto-adhesive	24,5 x 20 mm	300 cm S	black powd. (RAL 9005)	23,70
	162 14 32 100	Aluminium Angle edge - auto-adhesive	24,5 x 20 mm	100 cm SB	black powd. (RAL 9005)	8,55
	162 14 50 100	Aluminium Angle edge - auto-adhesive	24,5 x 20 mm	100 cm SB	metallic anthracite	10,60
	162 14 52 100	Aluminium Angle edge - auto-adhesive	24,5 x 20 mm	100 cm SB	metallic grey	10,60
	162 44 20 270	Aluminium Angle edge - auto-adhesive	24,5 x 20 mm	270 cm S	beech	24,45
	162 44 21 270	Aluminium Angle edge - auto-adhesive	24,5 x 20 mm	270 cm S	dark oak	24,45
	162 44 25 270	Aluminium Angle edge - auto-adhesive	24,5 x 20 mm	270 cm S	light oak	24,45
	162 44 24 270	Aluminium Angle edge - auto-adhesive	24,5 x 20 mm	270 cm S	walnut	24,45
	162 44 28 270	Aluminium Angle edge - auto-adhesive	24,5 x 20 mm	270 cm S	grey oak	24,45
		168 14 10 250	Aluminium Angle edge - auto-adhesive on both sides.	30 x 24,5 mm	250 cm S	gold
168 14 13 250		Aluminium Angle edge - auto-adhesive on both sides.	30 x 24,5 mm	250 cm S	sahara	26,90
168 14 11 300		Aluminium Angle edge - auto-adhesive on both sides.	30 x 24,5 mm	300 cm S	silver	30,15
168 14 11 250		Aluminium Angle edge - auto-adhesive on both sides.	30 x 24,5 mm	250 cm S	silver	25,15
168 14 11 100		Aluminium Angle edge - auto-adhesive on both sides.	30 x 24,5 mm	100 cm SB	silver	10,60
168 14 12 250		Aluminium Angle edge - auto-adhesive on both sides.	30 x 24,5 mm	250 cm S	bronze	28,15
168 14 14 300		Aluminium Angle edge - auto-adhesive on both sides.	30 x 24,5 mm	300 cm S	stainless steel matt	33,90
168 14 14 250		Aluminium Angle edge - auto-adhesive on both sides.	30 x 24,5 mm	250 cm S	stainless steel matt	28,15
168 14 14 100		Aluminium Angle edge - auto-adhesive on both sides.	30 x 24,5 mm	100 cm SB	stainless steel matt	11,80
168 14 32 300		Aluminium Angle edge - auto-adhesive on both sides.	30 x 24,5 mm	300 cm S	black powd. (RAL 9005)	36,45
		180 13 02 500	Brass Angle edge - countersunk holes	21 x 21 mm	500 cm	brass, not polished
	180 13 02 250	Brass Angle edge - countersunk holes	21 x 21 mm	250 cm	brass, not polished	57,50

Schets	Artikelnummer	Omschrijving	Afmeting	Lengte	Kleur	Bruto verkoopprijs / st.
--------	---------------	--------------	----------	--------	-------	--------------------------

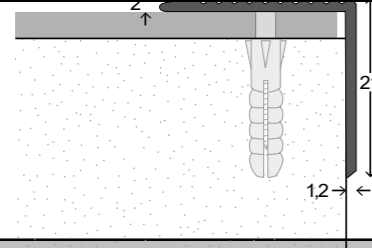

181 13 03 500	Brass Angle edge - countersunk holes	30 x 30 mm	500 cm	MS poliert	Op aanvraag
181 13 03 250	Brass Angle edge - countersunk holes	30 x 30 mm	250 cm	MS poliert	110,65

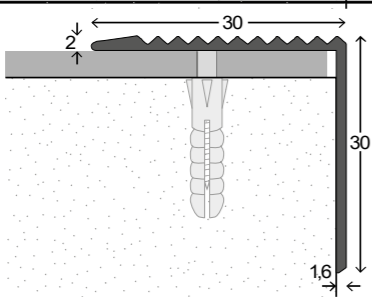

Stair Nosings

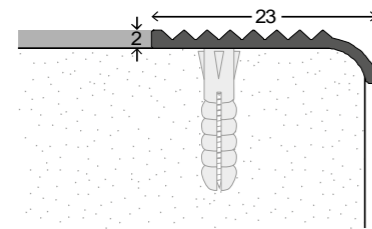

173 13 10 250	Aluminium Stair nosing - countersunk screw holes	23 mm	250 cm	gold	17,25
173 13 10 100	Aluminium Stair nosing - countersunk screw holes	23 mm	100 cm SB	gold	7,95
173 13 11 250	Aluminium Stair nosing - countersunk screw holes	23 mm	250 cm	silver	15,90
173 13 11 100	Aluminium Stair nosing - countersunk screw holes	23 mm	100 cm SB	silver	7,35
173 13 14 250	Aluminium Stair nosing - countersunk screw holes	23 mm	250 cm	stainless steel matt	18,00

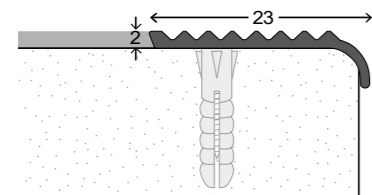

183 13 02 500	Pure Brass Stair nosing - countersunk screw holes	23 mm	500 cm	brass, not polished	Op aanvraag
---------------	---	-------	--------	---------------------	--------------------

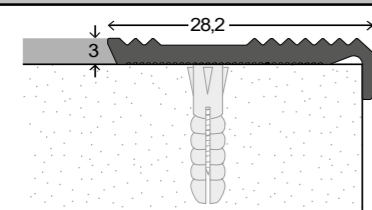

171 13 11 500	Aluminium Stair nosing - countersunk screw holes	28 mm	500 cm	silver	Op aanvraag
171 13 11 250	Aluminium Stair nosing - countersunk screw holes	28 mm	250 cm	silver	22,65

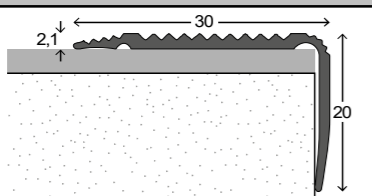

164 10 11 500	Aluminium Stair nosing NOVA - without screw holes.	30 x 20 mm	500 cm	silver	Op aanvraag
164 10 11 250	Aluminium Stair nosing NOVA - without screw holes.	30 x 20 mm	250 cm	silver	18,50

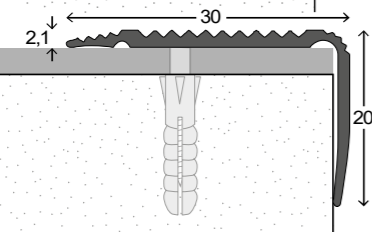

164 13 10 250	Aluminium Stair nosing NOVA - countersunk screw holes.	30 x 20 mm	250 cm	gold	21,00
164 13 10 100	Aluminium Stair nosing NOVA - countersunk screw holes.	30 x 20 mm	100 cm SB	gold	10,00
164 13 11 500	Aluminium Stair nosing NOVA - countersunk screw holes.	30 x 20 mm	500 cm	silver	Op aanvraag
164 13 11 250	Aluminium Stair nosing NOVA - countersunk screw holes.	30 x 20 mm	250 cm	silver	19,90
164 13 11 100	Aluminium Stair nosing NOVA - countersunk screw holes.	30 x 20 mm	100 cm SB	silver	9,35

Schets	Artikelnummer	Omschrijving	Afmeting	Lengte	Kleur	Bruto verkoopprijs / st.
	164 13 12 250	Aluminium Stair nosing NOVA - countersunk screw holes.	30 x 20 mm	250 cm	bronze	21,75
	164 13 12 100	Aluminium Stair nosing NOVA - countersunk screw holes.	30 x 20 mm	100 cm SB	bronze	10,20
	164 13 14 250	Aluminium Stair nosing NOVA - countersunk screw holes.	30 x 20 mm	250 cm	stainless steel matt	21,75
	164 13 14 100	Aluminium Stair nosing NOVA - countersunk screw holes.	30 x 20 mm	100 cm SB	stainless steel matt	10,20

	165 10 11 500	Aluminium Stair nosing NOVA - without screw holes.	35 x 30 mm	500 cm	silver	Op aanvraag
	165 10 11 250	Aluminium Stair nosing NOVA - without screw holes.	35 x 30 mm	250 cm	silver	25,50

	165 13 10 250	Aluminium Stair nosing NOVA - countersunk screw holes.	35 x 30 mm	250 cm	gold	28,90
	165 13 10 100	Aluminium Stair nosing NOVA - countersunk screw holes.	35 x 30 mm	100 cm SB	gold	12,65
	165 13 11 500	Aluminium Stair nosing NOVA - countersunk screw holes.	35 x 30 mm	500 cm	silver	Op aanvraag
	165 13 11 250	Aluminium Stair nosing NOVA - countersunk screw holes.	35 x 30 mm	250 cm	silver	26,90
	165 13 11 100	Aluminium Stair nosing NOVA - countersunk screw holes.	35 x 30 mm	100 cm SB	silver	11,85
	165 13 12 250	Aluminium Stair nosing NOVA - countersunk screw holes.	35 x 30 mm	250 cm	bronze	30,00
	165 13 12 100	Aluminium Stair nosing NOVA - countersunk screw holes.	35 x 30 mm	100 cm SB	bronze	13,70
	165 13 14 500	Aluminium Stair nosing NOVA - countersunk screw holes.	35 x 30 mm	500 cm	stainless steel matt	Op aanvraag
	165 13 14 250	Aluminium Stair nosing NOVA - countersunk screw holes.	35 x 30 mm	250 cm	stainless steel matt	30,00

	170 10 11 500	Aluminium Stair nosing NOVA - without screw holes.	45 x 23 mm	500 cm	silver	Op aanvraag
	170 10 11 250	Aluminium Stair nosing NOVA - without screw holes.	45 x 23 mm	250 cm	silver	27,40

	170 23 10 270	Aluminium Stair nosing NOVA - countersunk screw holes.	45 x 23 mm	270 cm	gold	33,10
	170 13 10 100	Aluminium Stair nosing NOVA - countersunk screw holes.	45 x 23 mm	100 cm SB	gold	13,30
	170 23 13 270	Aluminium Stair nosing NOVA - countersunk screw holes.	45 x 23 mm	270 cm	sahara	33,10
	170 13 13 100	Aluminium Stair nosing NOVA - countersunk screw holes.	45 x 23 mm	100 cm SB	sahara	13,30
	170 13 11 500	Aluminium Stair nosing NOVA - countersunk screw holes.	45 x 23 mm	500 cm	silver	Op aanvraag
	170 23 11 270	Aluminium Stair nosing NOVA - countersunk screw holes.	45 x 23 mm	270 cm	silver	30,95
	170 13 11 100	Aluminium Stair nosing NOVA - countersunk screw holes.	45 x 23 mm	100 cm SB	silver	12,45
	170 23 12 270	Aluminium Stair nosing NOVA - countersunk screw holes.	45 x 23 mm	270 cm	bronze	35,25
	170 13 12 100	Aluminium Stair nosing NOVA - countersunk screw holes.	45 x 23 mm	100 cm SB	bronze	14,05
	170 13 14 500	Aluminium Stair nosing NOVA - countersunk screw holes.	45 x 23 mm	500 cm	stainless steel matt	Op aanvraag
	170 23 14 270	Aluminium Stair nosing NOVA - countersunk screw holes.	45 x 23 mm	270 cm	stainless steel matt	35,25
	170 13 14 100	Aluminium Stair nosing NOVA - countersunk screw holes.	45 x 23 mm	100 cm SB	stainless steel matt	14,05

	172 10 11 500	Aluminium Stair nosing NOVA - without screw holes.	55 x 44 mm	500 cm	silver	Op aanvraag
	172 10 11 250	Aluminium Stair nosing NOVA - without screw holes.	55 x 44 mm	250 cm	silver	48,40

Schets	Artikelnummer	Omschrijving	Afmeting	Lengte	Kleur	Bruto verkoopprijs / st.
--------	---------------	--------------	----------	--------	-------	--------------------------

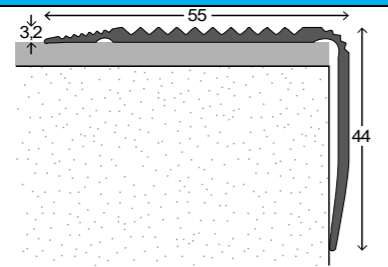

172 13 10 250	Aluminium Stair nosing NOVA - countersunk screw holes.	55 x 44 mm	250 cm	gold	56,65
172 13 11 500	Aluminium Stair nosing NOVA - countersunk screw holes.	55 x 44 mm	500 cm	silver	Op aanvraag
172 13 11 250	Aluminium Stair nosing NOVA - countersunk screw holes.	55 x 44 mm	250 cm	silver	51,65
172 13 12 500	Aluminium Stair nosing NOVA - countersunk screw holes.	55 x 44 mm	500 cm	bronze	Op aanvraag
172 13 12 250	Aluminium Stair nosing NOVA - countersunk screw holes.	55 x 44 mm	250 cm	bronze	59,25
172 13 14 500	Aluminium Stair nosing NOVA - countersunk screw holes.	55 x 44 mm	500 cm	stainless steel matt	Op aanvraag
172 13 14 250	Aluminium Stair nosing NOVA - countersunk screw holes.	55 x 44 mm	250 cm	stainless steel matt	59,25

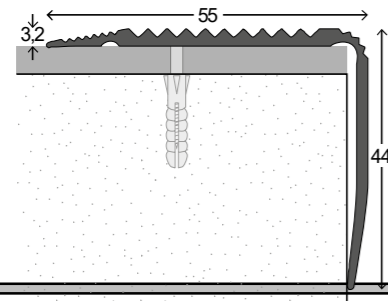

166 10 11 500	Aluminium Stair nosing NOVA - without screw holes.	70 x 44 mm	500 cm	silver	Op aanvraag
166 10 11 250	Aluminium Stair nosing NOVA - without screw holes.	70 x 44 mm	250 cm	silver	55,65

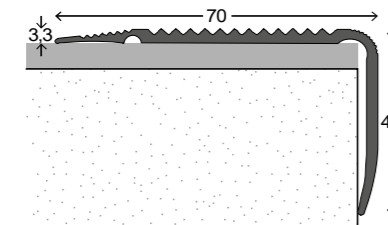

166 13 11 500	Aluminium Stair nosing NOVA - countersunk screw holes.	70 x 44 mm	500 cm	silver	Op aanvraag
166 13 11 250	Aluminium Stair nosing NOVA - countersunk screw holes.	70 x 44 mm	250 cm	silver	60,65
166 13 14 500	Aluminium Stair nosing NOVA - countersunk screw holes.	70 x 44 mm	500 cm	stainless steel matt	Op aanvraag
166 13 14 250	Aluminium Stair nosing NOVA - countersunk screw holes.	70 x 44 mm	250 cm	stainless steel matt	68,00

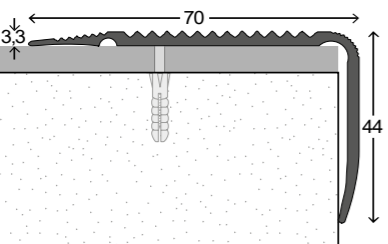

To use with PVC anti slipping insert. The price does not include the insert.

179 13 11 500	Aluminium Stair nosing NOVA - countersunk screw holes.	45 x 23 mm	500 cm	silver	Op aanvraag
179 13 11 250	Aluminium Stair nosing NOVA - countersunk screw holes.	45 x 23 mm	250 cm	silver	29,25

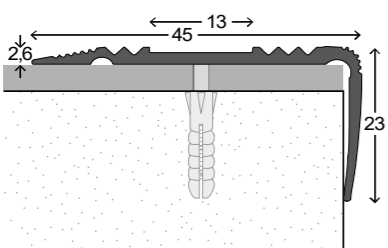

To use with stair nosing sections no. 179 and 174.

824 21 40 025	PVC anti-slipping insert - auto-adhesive	13 mm	25 m	brown	77,50
824 21 41 025	PVC anti-slipping insert - auto-adhesive	13 mm	25 m	beige	77,50
824 21 42 025	PVC anti-slipping insert - auto-adhesive	13 mm	25 m	grey	77,50
824 21 32 025	PVC anti-slipping insert - auto-adhesive	13 mm	25 m	black	77,50

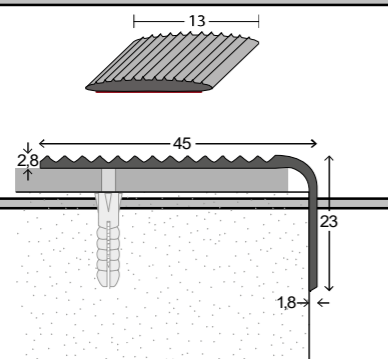

182 13 03 500	Pure Brass Stair nosing - countersunk screw holes	45 x 23 mm	500 cm	brass polished	Op aanvraag
182 13 03 250	Pure Brass Stair nosing - countersunk screw holes	45 x 23 mm	250 cm	brass polished	144,15

Schets	Artikelnummer	Omschrijving	Afmeting	Lengte	Kleur	Bruto verkoopprijs / st.
--------	---------------	--------------	----------	--------	-------	--------------------------

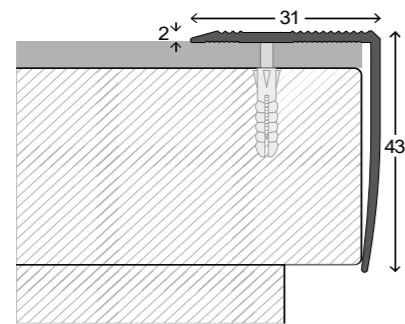

163 13 11 500	Aluminium Stair nosing - countersunk screw holes	31 x 43 mm	500 cm	silver	Op aanvraag
163 13 11 250	Aluminium Stair nosing - countersunk screw holes	31 x 43 mm	250 cm	silver	27,75
163 13 14 500	Aluminium Stair nosing - countersunk screw holes	31 x 43 mm	500 cm	stainless steel matt	Op aanvraag
163 13 14 250	Aluminium Stair nosing - countersunk screw holes	31 x 43 mm	250 cm	stainless steel matt	31,00

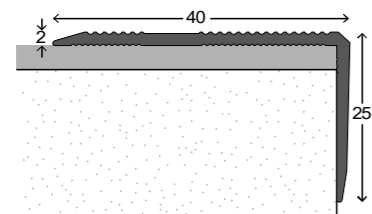

293 10 11 500	Aluminium Stair nosing - without screw holes	40 x 25 mm	500 cm	silver	Op aanvraag
293 10 11 250	Aluminium Stair nosing - without screw holes	40 x 25 mm	250 cm	silver	24,40

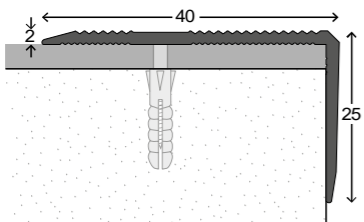

293 13 10 250	Aluminium Stair nosing - countersunk screw holes	40 x 25 mm	250 cm	gold	26,40
293 13 10 100	Aluminium Stair nosing - countersunk screw holes	40 x 25 mm	100 cm SB	gold	11,60
293 13 13 250	Aluminium Stair nosing - countersunk screw holes	40 x 25 mm	250 cm	sahara	26,40
293 13 13 100	Aluminium Stair nosing - countersunk screw holes	40 x 25 mm	100 cm SB	sahara	11,60
293 13 11 500	Aluminium Stair nosing - countersunk screw holes	40 x 25 mm	500 cm	silver	Op aanvraag
293 13 11 250	Aluminium Stair nosing - countersunk screw holes	40 x 25 mm	250 cm	silver	24,25
293 13 11 250 SB	Aluminium Stair nosing - countersunk screw holes - incl. screws and plugs	40 x 25 mm	250 cm SB	silver	26,75
293 13 11 100	Aluminium Stair nosing - countersunk screw holes	40 x 25 mm	100 cm SB	silver	10,70
293 13 14 250	Aluminium Stair nosing - countersunk screw holes	40 x 25 mm	250 cm	stainless steel matt	28,25
293 13 14 100	Aluminium Stair nosing - countersunk screw holes	40 x 25 mm	100 cm SB	stainless steel matt	12,30

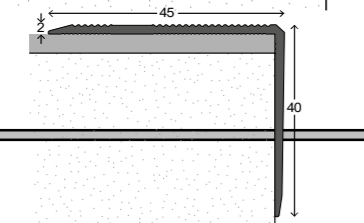

294 10 11 500	Aluminium Stair nosing - without screw holes	45 x 40 mm	500 cm	silver	Op aanvraag
294 10 11 250	Aluminium Stair nosing - without screw holes	45 x 40 mm	250 cm	silver	30,40

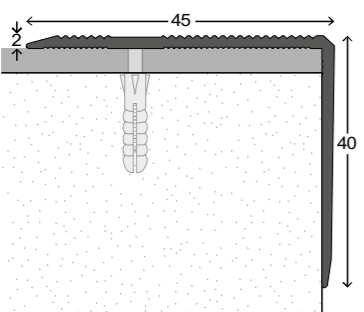

294 13 13 500	Aluminium Stair nosing - countersunk screw holes	45 x 40 mm	500 cm	sahara	Op aanvraag
294 13 13 250	Aluminium Stair nosing - countersunk screw holes	45 x 40 mm	250 cm	sahara	33,75
294 13 13 100	Aluminium Stair nosing - countersunk screw holes	45 x 40 mm	100 cm SB	sahara	14,55
294 13 11 500	Aluminium Stair nosing - countersunk screw holes	45 x 40 mm	500 cm	silver	Op aanvraag
294 13 11 250	Aluminium Stair nosing - countersunk screw holes	45 x 40 mm	250 cm	silver	31,15
294 13 11 250 SB	Aluminium Stair nosing - countersunk screw holes - incl. screws and plugs	45 x 40 mm	250 cm SB	silver	33,65
294 13 11 100	Aluminium Stair nosing - countersunk screw holes	45 x 40 mm	100 cm SB	silver	13,45
294 13 14 250	Aluminium Stair nosing - countersunk screw holes	45 x 40 mm	250 cm	stainless steel matt	36,15
294 13 14 100	Aluminium Stair nosing - countersunk screw holes	45 x 40 mm	100 cm SB	stainless steel matt	15,45

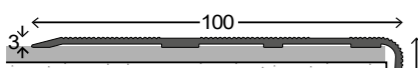

190 10 11 500	Aluminium Stair nosing - without screw holes	100 x 36 mm	500 cm	silver	Op aanvraag
190 10 11 250	Aluminium Stair nosing - without screw holes	100 x 36 mm	250 cm	silver	64,25

Schets	Artikelnummer	Omschrijving	Afmeting	Lengte	Kleur	Bruto verkoopprijs / st.
--------	---------------	--------------	----------	--------	-------	--------------------------



190 13 11 500	Aluminium Stair nosing - countersunk screw holes	100 x 36 mm	500 cm	silver	Op aanvraag
190 13 11 250	Aluminium Stair nosing - countersunk screw holes	100 x 36 mm	250 cm	silver	70,50

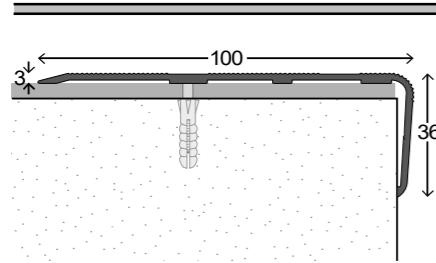

930 23 11 270	Aluminium Stair nosing - countersunk screw holes	62 x 36 mm	270 cm	silver	60,90
---------------	--	------------	--------	--------	--------------

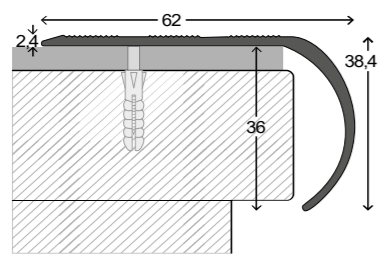

LED-Stair Nosings

- > The LED-Stair Nosing no. 218 is suitable for all kinds of floorings.
- > For straight and spiral stairs.
- > The profile can be installed on flyers and undercut steps.
- > The LED-diffusor (cover cap) is optional. In case of need it has to be ordered separately.

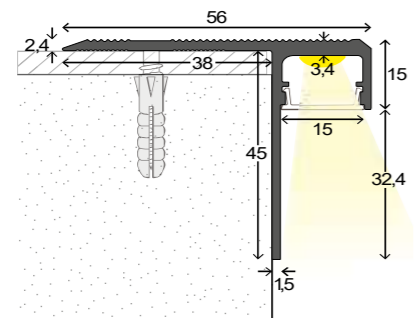

218 13 11 500	Aluminium Stair nosing with LED channel	56 x 47,5 mm	500 cm	silver	Op aanvraag
218 13 11 250	Aluminium Stair nosing with LED channel	56 x 47,5 mm	250 cm	silver	51,75
218 13 14 500	Aluminium Stair nosing with LED channel	56 x 47,5 mm	500 cm	stainless steel matt	Op aanvraag
218 13 14 250	Aluminium Stair nosing with LED channel	56 x 47,5 mm	250 cm	stainless steel matt	58,50

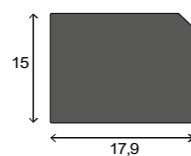

218 00 11 000	Aluminium End cap for Stair nosing with LED channel no. 218			silver	5,90
---------------	---	--	--	--------	-------------

- > The LED-Stair Nosing no. 219 has been designed for design floorings of 3 mm thickness.
- > The flooring has to be glued into the home screwed profile. Only the 2 mm small stop angle is visible from above.
- > The profile is suitable for straight and spiral stairs.
- > The profile can be installed on flyers and undercut steps.
- > On the step riser the flooring can either be installed under or on the vertical flank of the profile.
- > The LED-diffusor (cover cap) is optional. In case of need it has to be ordered separately.

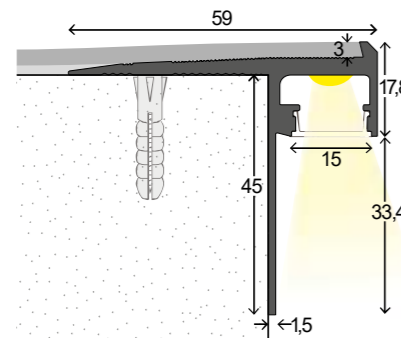

219 13 11 500	Aluminium Stair nosing with LED channel - for floorings up to 3 mm	59 x 51,2 mm	500 cm	silver	Op aanvraag
219 13 11 250	Aluminium Stair nosing with LED channel - for floorings up to 3 mm	59 x 51,2 mm	250 cm	silver	55,40
219 13 14 500	Aluminium Stair nosing with LED channel - for floorings up to 3 mm	59 x 51,2 mm	500 cm	stainless steel matt	Op aanvraag
219 13 14 250	Aluminium Stair nosing with LED channel - for floorings up to 3 mm	59 x 51,2 mm	250 cm	stainless steel matt	63,50

219 00 11 000	Aluminium End cap for LED Stair nosing no. 219			silver	5,90
---------------	--	--	--	--------	-------------

Schets	Artikelnummer	Omschrijving	Afmeting	Lengte	Kleur	Bruto verkoopprijs / st.
--------	---------------	--------------	----------	--------	-------	--------------------------

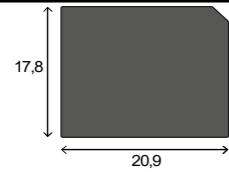

354 20 00 400	LED Diffusor (cover cap) - PET	15 mm	400 cm	translucent	21,20
354 20 00 250	LED Diffusor (cover cap) - PET	15 mm	250 cm	translucent	13,90

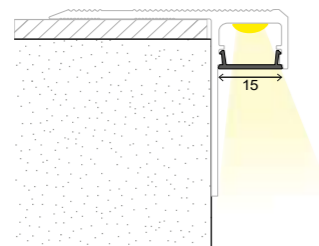

Stair Nosings with Anti-Slip Insert

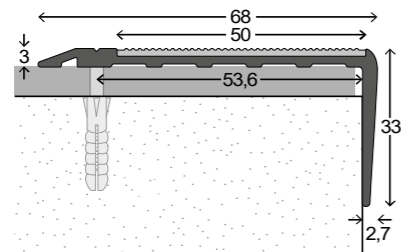

217 13 11 500	Aluminium Stair nosing - countersunk screw holes. Including anti-slip insert.	68 x 33 mm	500 cm	silver / black	Op aanvraag
217 13 11 250	Aluminium Stair nosing - countersunk screw holes. Including anti-slip insert.	68 x 33 mm	250 cm	silver / black	56,65

The stair nosing is assembled completely with anti-slip insert.

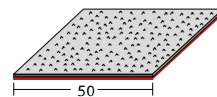

217 00 32 000	Anti-slipping insert / spare strip	50 mm	5 m	black	27,25
---------------	------------------------------------	-------	-----	-------	--------------

Treppenkantenprofile DUO

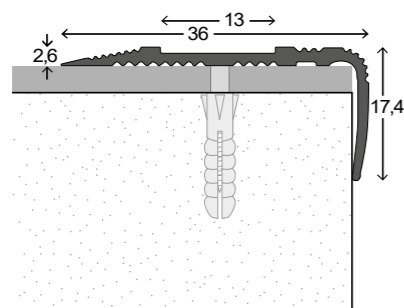

174 13 11 500	Aluminium Stair nosing DUO - countersunk screw holes. Inserts not included.	36 x 17,4 mm	500 cm	silver	Op aanvraag
174 13 11 250	Aluminium Stair nosing DUO - countersunk screw holes. Inserts not included.	36 x 17,4 mm	250 cm	silver	23,40
174 13 14 500	Aluminium Stair nosing DUO - countersunk screw holes. Inserts not included.	36 x 17,4 mm	500 cm	stainless steel matt	Op aanvraag
174 13 14 250	Aluminium Stair nosing DUO - countersunk screw holes. Inserts not included.	36 x 17,4 mm	250 cm	stainless steel matt	26,75

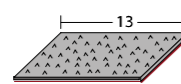
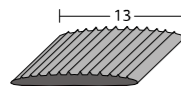

824 21 40 025	PVC anti-slipping insert - auto-adhesive	13 mm	25 m	brown	77,50
824 21 41 025	PVC anti-slipping insert - auto-adhesive	13 mm	25 m	beige	77,50
824 21 42 025	PVC anti-slipping insert - auto-adhesive	13 mm	25 m	grey	77,50
824 21 32 025	PVC anti-slipping insert - auto-adhesive	13 mm	25 m	black	77,50

824 22 40 025	PVC anti-slipping insert - auto-adhesive. With anti-slipping surface. For item no. 174.	13 mm	25 m	brown	81,25
824 22 42 025	PVC anti-slipping insert - auto-adhesive. With anti-slipping surface. For item no. 174.	13 mm	25 m	grey	81,25
824 22 32 025	PVC anti-slipping insert - auto-adhesive. With anti-slipping surface. For item no. 174.	13 mm	25 m	black	81,25

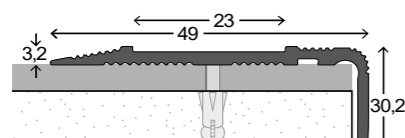

175 13 11 500	Aluminium Stair nosing DUO - countersunk screw holes. Inserts not included.	49 x 30,2 mm	500 cm	silver	Op aanvraag
175 13 11 250	Aluminium Stair nosing DUO - countersunk screw holes. Inserts not included.	49 x 30,2 mm	250 cm	silver	36,15
175 13 14 500	Aluminium Stair nosing DUO - countersunk screw holes. Inserts not included.	49 x 30,2 mm	500 cm	stainless steel matt	Op aanvraag
175 13 14 250	Aluminium Stair nosing DUO - countersunk screw holes. Inserts not included.	49 x 30,2 mm	250 cm	stainless steel matt	40,75

Schets	Artikelnummer	Omschrijving	Afmeting	Lengte	Kleur	Bruto verkoopprijs / st.
--------	---------------	--------------	----------	--------	-------	--------------------------

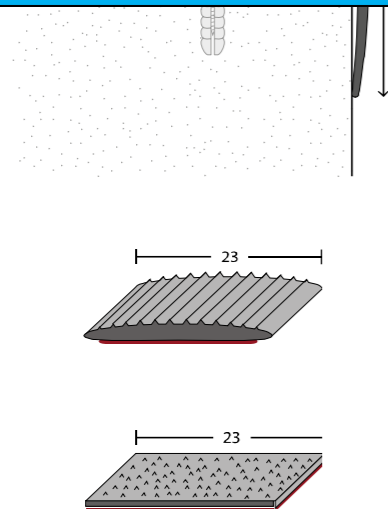

824 11 40 025	PVC anti-slipping insert - auto-adhesive. With anti-slipping grooves. For item no. 175.	23 mm	25 m	brown	105,00
824 11 41 025	PVC anti-slipping insert - auto-adhesive. With anti-slipping grooves. For item no. 175.	23 mm	25 m	beige	105,00
824 11 42 025	PVC anti-slipping insert - auto-adhesive. With anti-slipping grooves. For item no. 175.	23 mm	25 m	grey	105,00
824 11 32 025	PVC anti-slipping insert - auto-adhesive. With anti-slipping grooves. For item no. 175.	23 mm	25 m	black	105,00
824 12 40 025	PVC anti-slipping insert - auto-adhesive. With anti-slipping surface. For item no. 175.	23 mm	25 m	brown	121,25
824 12 42 025	PVC anti-slipping insert - auto-adhesive. With anti-slipping surface. For item no. 175.	23 mm	25 m	grey	121,25
824 12 32 025	PVC anti-slipping insert - auto-adhesive. With anti-slipping surface. For item no. 175.	23 mm	25 m	black	121,25

Stair Nosings

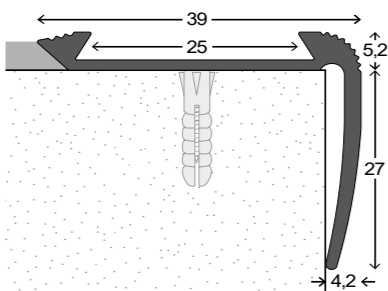

191 13 11 500	Aluminium Stair nosing - countersunk screw holes. Inserts not included.	39 x 32,2 mm	500 cm	silver	Op aanvraag
191 13 11 300	Aluminium Stair nosing - countersunk screw holes. Inserts not included.	39 x 32,2 mm	300 cm	silver	36,10
191 13 11 250	Aluminium Stair nosing - countersunk screw holes. Inserts not included.	39 x 32,2 mm	250 cm	silver	30,40
191 13 12 500	Aluminium Stair nosing - countersunk screw holes. Inserts not included.	39 x 32,2 mm	500 cm	bronze	Op aanvraag
191 13 12 250	Aluminium Stair nosing - countersunk screw holes. Inserts not included.	39 x 32,2 mm	250 cm	bronze	34,65
191 13 32 500	Aluminium Stair nosing - countersunk screw holes. Inserts not included.	39 x 32,2 mm	500 cm	black powd. (RAL 9005)	Op aanvraag
191 13 32 250	Aluminium Stair nosing - countersunk screw holes. Inserts not included.	39 x 32,2 mm	250 cm	black powd. (RAL 9005)	40,75

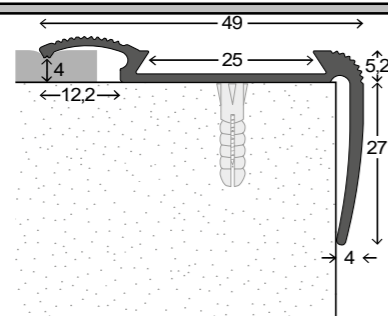

192 13 10 500	Aluminium Stair nosing with fold-back edge - countersunk screw holes. Inserts not included.	49 x 32,2 mm	500 cm	gold	Op aanvraag
192 13 10 250	Aluminium Stair nosing with fold-back edge - countersunk screw holes. Inserts not included.	49 x 32,2 mm	250 cm	gold	40,00
192 13 11 500	Aluminium Stair nosing with fold-back edge - countersunk screw holes. Inserts not included.	49 x 32,2 mm	500 cm	silver	Op aanvraag
192 13 11 300	Aluminium Stair nosing with fold-back edge - countersunk screw holes. Inserts not included.	49 x 32,2 mm	300 cm	silver	41,70
192 13 11 250	Aluminium Stair nosing with fold-back edge - countersunk screw holes. Inserts not included.	49 x 32,2 mm	250 cm	silver	35,15
192 13 12 500	Aluminium Stair nosing with fold-back edge - countersunk screw holes. Inserts not included.	49 x 32,2 mm	500 cm	bronze	Op aanvraag
192 13 12 250	Aluminium Stair nosing with fold-back edge - countersunk screw holes. Inserts not included.	49 x 32,2 mm	250 cm	bronze	40,25
192 13 32 500	Aluminium Stair nosing with fold-back edge - countersunk screw holes. Inserts not included.	49 x 32,2 mm	500 cm	black powd. (RAL 9005)	Op aanvraag
192 13 32 250	Aluminium Stair nosing with fold-back edge - countersunk screw holes. Inserts not included.	49 x 32,2 mm	250 cm	black powd. (RAL 9005)	47,40

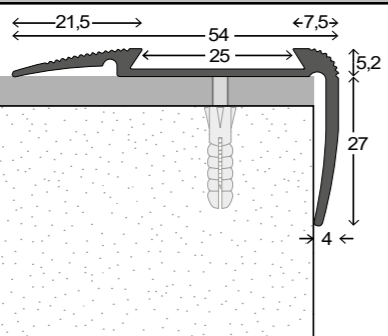

193 13 10 500	Aluminium Stair nosing - countersunk screw holes. Inserts not included.	54 x 32,2 mm	500 cm	gold	Op aanvraag
193 13 10 250	Aluminium Stair nosing - countersunk screw holes. Inserts not included.	54 x 32,2 mm	250 cm	gold	44,75
193 13 11 500	Aluminium Stair nosing - countersunk screw holes. Inserts not included.	54 x 32,2 mm	500 cm	silver	Op aanvraag
193 13 11 300	Aluminium Stair nosing - countersunk screw holes. Inserts not included.	54 x 32,2 mm	300 cm	silver	47,80
193 13 11 250	Aluminium Stair nosing - countersunk screw holes. Inserts not included.	54 x 32,2 mm	250 cm	silver	39,00
193 13 12 500	Aluminium Stair nosing - countersunk screw holes. Inserts not included.	54 x 32,2 mm	500 cm	bronze	Op aanvraag
193 13 12 250	Aluminium Stair nosing - countersunk screw holes. Inserts not included.	54 x 32,2 mm	250 cm	bronze	46,00
193 13 32 500	Aluminium Stair nosing - countersunk screw holes. Inserts not included.	54 x 32,2 mm	500 cm	black powd. (RAL 9005)	Op aanvraag
193 13 32 250	Aluminium Stair nosing - countersunk screw holes. Inserts not included.	54 x 32,2 mm	250 cm	black powd. (RAL 9005)	54,50

194 13 10 500	Aluminium Stair nosing - countersunk screw holes. Inserts not included.	54 x 49,2 mm	500 cm	gold	Op aanvraag
194 13 10 250	Aluminium Stair nosing - countersunk screw holes. Inserts not included.	54 x 49,2 mm	250 cm	gold	51,25
194 13 11 500	Aluminium Stair nosing - countersunk screw holes. Inserts not included.	54 x 49,2 mm	500 cm	silver	Op aanvraag

Schets	Artikelnummer	Omschrijving	Afmeting	Lengte	Kleur	Bruto verkoopprijs / st.
	194 13 11 300	Aluminium Stair nosing - countersunk screw holes. Inserts not included.	54 x 49,2 mm	300 cm	silver	54,35
	194 13 11 250	Aluminium Stair nosing - countersunk screw holes. Inserts not included.	54 x 49,2 mm	250 cm	silver	45,25
	194 13 12 500	Aluminium Stair nosing - countersunk screw holes. Inserts not included.	54 x 49,2 mm	500 cm	bronze	Op aanvraag
	194 13 12 250	Aluminium Stair nosing - countersunk screw holes. Inserts not included.	54 x 49,2 mm	250 cm	bronze	52,90
	194 13 32 500	Aluminium Stair nosing - countersunk screw holes. Inserts not included.	54 x 49,2 mm	500 cm	black powd. (RAL 9005)	Op aanvraag
	194 13 32 250	Aluminium Stair nosing - countersunk screw holes. Inserts not included.	54 x 49,2 mm	250 cm	black powd. (RAL 9005)	62,25

	199 13 10 250	Aluminium Stair nosing - countersunk screw holes. Inserts not included.	63 x 50 mm	250 cm	gold	55,25
	199 13 11 500	Aluminium Stair nosing - countersunk screw holes. Inserts not included.	63 x 50 mm	500 cm	silver	Op aanvraag
	199 13 11 250	Aluminium Stair nosing - countersunk screw holes. Inserts not included.	63 x 50 mm	250 cm	silver	48,40
	199 13 12 500	Aluminium Stair nosing - countersunk screw holes. Inserts not included.	63 x 50 mm	500 cm	bronze	Op aanvraag
	199 13 12 250	Aluminium Stair nosing - countersunk screw holes. Inserts not included.	63 x 50 mm	250 cm	bronze	55,40
	199 13 32 500	Aluminium Stair nosing - countersunk screw holes. Inserts not included.	63 x 50 mm	500 cm	black powd. (RAL 9005)	Op aanvraag
	199 13 32 250	Aluminium Stair nosing - countersunk screw holes. Inserts not included.	63 x 50 mm	250 cm	black powd. (RAL 9005)	64,65

	185 13 03 500	Brass Stair nosing - countersunk holes.	40 x 18 mm	500 cm	brass with mirror finish	Op aanvraag
	185 13 03 250	Brass Stair nosing - countersunk holes.	40 x 18 mm	250 cm	brass with mirror finish	124,65

	186 13 03 500	Brass Stair nosing - countersunk holes.	40 x 32 mm	500 cm	brass with mirror finish	Op aanvraag
	186 13 03 250	Brass Stair nosing - countersunk holes.	40 x 32 mm	250 cm	brass with mirror finish	138,25

	825 10 32 025	Soft-PVC insert for stair nosings - plain	25 mm	25 m	black	71,25
	825 10 42 025	Soft-PVC insert for stair nosings - plain	25 mm	25 m	grey	71,25
	825 10 41 025	Soft-PVC insert for stair nosings - plain	25 mm	25 m	beige	71,25
	825 10 40 025	Soft-PVC insert for stair nosings - plain	25 mm	25 m	brown	71,25
	825 10 35 025	Soft-PVC insert for stair nosings - plain	25 mm	25 m	red	71,25

825 10 43 025	Soft-PVC insert for stair nosings - plain	25 mm	25 m	luminescent	126,25
---------------	---	-------	------	-------------	---------------

	825 20 32 025	Soft-PVC insert for stair nosings - grooved	25 mm	25 m	black	72,50
	825 20 34 025	Soft-PVC insert for stair nosings - grooved	25 mm	25 m	yellow	72,50
	825 20 42 025	Soft-PVC insert for stair nosings - grooved	25 mm	25 m	grey	72,50
	825 20 41 025	Soft-PVC insert for stair nosings - grooved	25 mm	25 m	beige	72,50
	825 20 40 025	Soft-PVC insert for stair nosings - grooved	25 mm	25 m	brown	72,50
	825 20 35 025	Soft-PVC insert for stair nosings - grooved	25 mm	25 m	red	72,50

825 20 43 025	Soft-PVC insert for stair nosings - grooved	25 mm	25 m	luminescent	130,00
---------------	---	-------	------	-------------	---------------

Schets	Artikelnummer	Omschrijving	Afmeting	Lengte	Kleur	Bruto verkoopprijs / st.
Stair Nosings for Design Floorings						
	178 13 11 500	Aluminium Stair nosing - countersunk screw hole - for floor coverings 2,5 mm.	45 x 10 mm	500 cm	silver	Op aanvraag
	178 13 11 250	Aluminium Stair nosing - countersunk screw hole - for floor coverings 2,5 mm.	45 x 10 mm	250 cm	silver	20,90
	178 13 14 500	Aluminium Stair nosing - countersunk screw hole - for floor coverings 2,5 mm.	45 x 10 mm	500 cm	stainless steel matt	Op aanvraag
	178 13 14 250	Aluminium Stair nosing - countersunk screw hole - for floor coverings 2,5 mm.	45 x 10 mm	250 cm	stainless steel matt	24,25
	178 13 32 500	Aluminium Stair nosing - countersunk screw hole - for floor coverings 2,5 mm.	45 x 10 mm	500 cm	black powd. (RAL 9005)	Op aanvraag
	178 13 32 250	Aluminium Stair nosing - countersunk screw hole - for floor coverings 2,5 mm.	45 x 10 mm	250 cm	black powd. (RAL 9005)	25,50
	195 13 11 500	Aluminium Stair nosing - countersunk screw hole - for floor coverings 2 mm.	45 x 18,5 mm	500 cm	silver	Op aanvraag
	195 13 11 250	Aluminium Stair nosing - countersunk screw hole - for floor coverings 2 mm.	45 x 18,5 mm	250 cm	silver	22,15
	195 13 14 500	Aluminium Stair nosing - countersunk screw hole - for floor coverings 2 mm.	45 x 18,5 mm	500 cm	stainless steel matt	Op aanvraag
	195 13 14 250	Aluminium Stair nosing - countersunk screw hole - for floor coverings 2 mm.	45 x 18,5 mm	250 cm	stainless steel matt	25,65
	196 13 11 500	Aluminium Stair nosing - countersunk screw hole - for floor coverings 2,5 mm.	45 x 19 mm	500 cm	silver	Op aanvraag
	196 13 11 250	Aluminium Stair nosing - countersunk screw hole - for floor coverings 2,5 mm.	45 x 19 mm	250 cm	silver	22,40
	196 13 14 500	Aluminium Stair nosing - countersunk screw hole - for floor coverings 2,5 mm.	45 x 19 mm	500 cm	stainless steel matt	Op aanvraag
	196 13 14 250	Aluminium Stair nosing - countersunk screw hole - for floor coverings 2,5 mm.	45 x 19 mm	250 cm	stainless steel matt	26,00
	197 13 11 500	Aluminium Stair nosing - countersunk screw hole - for floor coverings 3 mm.	45 x 19,5 mm	500 cm	silver	Op aanvraag
	197 13 11 250	Aluminium Stair nosing - countersunk screw hole - for floor coverings 3 mm.	45 x 19,5 mm	250 cm	silver	22,90
	197 13 11 250 SB	Aluminium Stair nosing - countersunk screw hole - for floor coverings 3 mm incl. screws	45 x 19,5 mm	250 cm SB	silver	25,40
	197 13 14 500	Aluminium Stair nosing - countersunk screw hole - for floor coverings 3 mm.	45 x 19,5 mm	500 cm	stainless steel matt	Op aanvraag
	197 13 14 250	Aluminium Stair nosing - countersunk screw hole - for floor coverings 3 mm.	45 x 19,5 mm	250 cm	stainless steel matt	26,65
	198 13 11 500	Aluminium Stair nosing - countersunk screw hole - for floor coverings 5 mm.	45 x 21,5 mm	500 cm	silver	Op aanvraag
	198 13 11 250	Aluminium Stair nosing - countersunk screw hole - for floor coverings 5 mm.	45 x 21,5 mm	250 cm	silver	23,65
	198 13 14 500	Aluminium Stair nosing - countersunk screw hole - for floor coverings 5 mm.	45 x 21,5 mm	500 cm	stainless steel matt	Op aanvraag
	198 13 14 250	Aluminium Stair nosing - countersunk screw hole - for floor coverings 5 mm.	45 x 21,5 mm	250 cm	stainless steel matt	27,40
	288 13 13 250	Aluminium Stair nosing - countersunk screw hole - for floor coverings 3 mm.	45 x 48,5 mm	250 cm	sahara	34,65
	288 13 11 500	Aluminium Stair nosing - countersunk screw hole - for floor coverings 3 mm.	45 x 48,5 mm	500 cm	silver	Op aanvraag
	288 13 11 250	Aluminium Stair nosing - countersunk screw hole - for floor coverings 3 mm.	45 x 48,5 mm	250 cm	silver	30,90
	288 13 14 500	Aluminium Stair nosing - countersunk screw hole - for floor coverings 3 mm.	45 x 48,5 mm	500 cm	stainless steel matt	Op aanvraag
	288 13 14 250	Aluminium Stair nosing - countersunk screw hole - for floor coverings 3 mm.	45 x 48,5 mm	250 cm	stainless steel matt	35,75
	286 13 13 250	Aluminium stair nosing - countersunk screw holes - for floor coverings 2 mm.	39 x 25 mm	250 cm	sahara	25,15
	286 13 11 500	Aluminium stair nosing - countersunk screw holes - for floor coverings 2 mm.	39 x 25 mm	500 cm	silver	Op aanvraag
	286 13 11 250	Aluminium stair nosing - countersunk screw holes - for floor coverings 2 mm.	39 x 25 mm	250 cm	silver	22,40
	286 13 14 500	Aluminium stair nosing - countersunk screw holes - for floor coverings 2 mm.	39 x 25 mm	500 cm	stainless steel matt	Op aanvraag
	286 13 14 250	Aluminium stair nosing - countersunk screw holes - for floor coverings 2 mm.	39 x 25 mm	250 cm	stainless steel matt	26,40

Schets	Artikelnummer	Omschrijving	Afmeting	Lengte	Kleur	Bruto verkoopprijs / st.
	286 13 32 250	Aluminium stair nosing - countersunk screw holes - for floor coverings 2 mm.	39 x 25 mm	250 cm	black powdercoated RAL 9005	28,50

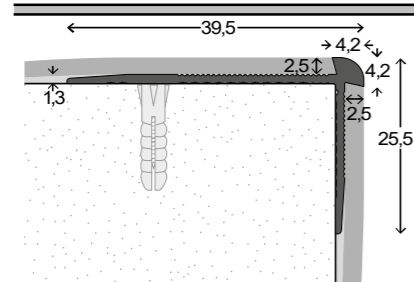

287 13 13 250	Aluminium stair nosing - countersunk screw holes - for floor coverings 2,5 mm.	39,5 x 25,5 mm	250 cm	sahara	25,65
287 13 11 500	Aluminium stair nosing - countersunk screw holes - for floor coverings 2,5 mm.	39,5 x 25,5 mm	500 cm	silver	Op aanvraag
287 13 11 250	Aluminium stair nosing - countersunk screw holes - for floor coverings 2,5 mm.	39,5 x 25,5 mm	250 cm	silver	22,90
287 13 14 500	Aluminium stair nosing - countersunk screw holes - for floor coverings 2,5 mm.	39,5 x 25,5 mm	500 cm	stainless steel matt	Op aanvraag
287 13 14 250	Aluminium stair nosing - countersunk screw holes - for floor coverings 2,5 mm.	39,5 x 25,5 mm	250 cm	stainless steel matt	27,00
287 13 32 250	Aluminium stair nosing - countersunk screw holes - for floor coverings 2,5 mm.	39,5 x 25,5 mm	250 cm	black powd. (RAL 9005)	28,90

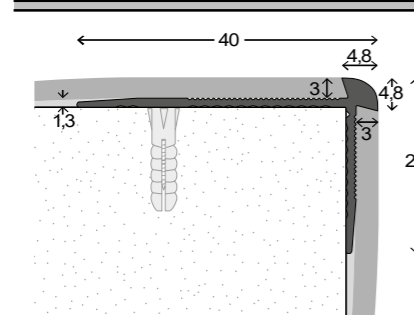

187 13 13 250	Aluminium stair nosing - countersunk screw holes - for floor coverings 3 mm.	40 x 26 mm	250 cm	sahara	26,00
187 13 11 500	Aluminium stair nosing - countersunk screw holes - for floor coverings 3 mm.	40 x 26 mm	500 cm	silver	Op aanvraag
187 13 11 300	Aluminium stair nosing - countersunk screw holes - for floor coverings 3 mm.	40 x 26 mm	300 cm	silver	27,80
187 13 11 250	Aluminium stair nosing - countersunk screw holes - for floor coverings 3 mm.	40 x 26 mm	250 cm	silver	23,25
187 13 11 250 SB	Aluminium stair nosing - countersunk screw holes - for floor coverings 3 mm. Incl. screws	40 x 26 mm	250 cm SB	silver	25,90
187 13 14 500	Aluminium stair nosing - countersunk screw holes - for floor coverings 3 mm.	40 x 26 mm	500 cm	stainless steel matt	Op aanvraag
187 13 14 250	Aluminium stair nosing - countersunk screw holes - for floor coverings 3 mm.	40 x 26 mm	250 cm	stainless steel matt	27,50
187 13 14 250 SB	Aluminium stair nosing - countersunk screw holes - for floor coverings 3 mm. Incl. screws	40 x 26 mm	250 cm SB	stainless steel matt	30,00
187 13 32 500	Aluminium stair nosing - countersunk screw holes - for floor coverings 3 mm.	40 x 26 mm	500 cm	black powd. (RAL 9005)	Op aanvraag
187 13 32 250	Aluminium stair nosing - countersunk screw holes - for floor coverings 3 mm.	40 x 26 mm	250 cm	black powd. (RAL 9005)	29,00

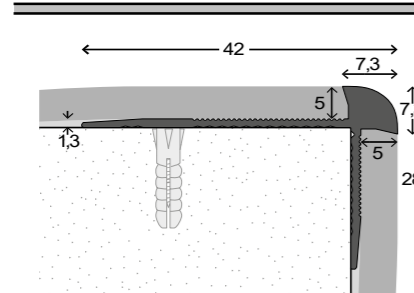

188 13 13 250	Aluminium stair nosing - countersunk screw holes - for floor coverings 5 mm.	42 x 28 mm	250 cm	sahara	29,25
188 13 11 500	Aluminium stair nosing - countersunk screw holes - for floor coverings 5 mm.	42 x 28 mm	500 cm	silver	Op aanvraag
188 13 11 250	Aluminium stair nosing - countersunk screw holes - for floor coverings 5 mm.	42 x 28 mm	250 cm	silver	26,15
188 13 14 500	Aluminium stair nosing - countersunk screw holes - for floor coverings 5 mm.	42 x 28 mm	500 cm	stainless steel matt	Op aanvraag
188 13 14 250	Aluminium stair nosing - countersunk screw holes - for floor coverings 5 mm.	42 x 28 mm	250 cm	stainless steel matt	30,25
188 13 32 250	Aluminium stair nosing - countersunk screw holes - for floor coverings 5 mm.	42 x 28 mm	250 cm	black powd. (RAL 9005)	33,15

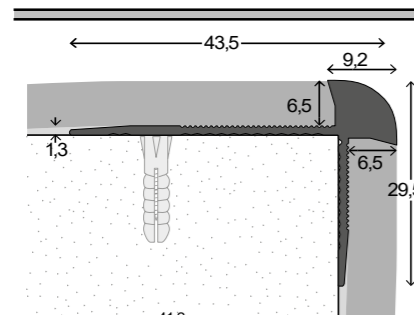

189 13 13 250	Aluminium stair nosing - countersunk screw holes - for floor coverings 6 - 6,5 mm.	43,5 x 29,5mm	250 cm	sahara	32,00
189 13 11 500	Aluminium stair nosing - countersunk screw holes - for floor coverings 6 - 6,5 mm.	43,5 x 29,5mm	500 cm	silver	Op aanvraag
189 13 11 250	Aluminium stair nosing - countersunk screw holes - for floor coverings 6 - 6,5 mm.	43,5 x 29,5mm	250 cm	silver	28,65
189 13 14 500	Aluminium stair nosing - countersunk screw holes - for floor coverings 6 - 6,5 mm.	43,5 x 29,5mm	500 cm	stainless steel matt	Op aanvraag
189 13 14 250	Aluminium stair nosing - countersunk screw holes - for floor coverings 6 - 6,5 mm.	43,5 x 29,5mm	250 cm	stainless steel matt	33,25

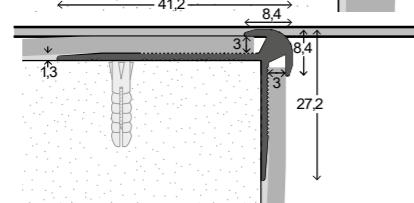

289 13 11 500	Aluminium stair nosing - countersunk screw holes - for floor coverings 3 mm.	41,2 x 27,2 mm	500 cm	silver	Op aanvraag
289 13 11 250	Aluminium stair nosing - countersunk screw holes - for floor coverings 3 mm.	41,2 x 27,2 mm	250 cm	silver	26,40
289 13 11 250 SB	Aluminium stair nosing - countersunk screw holes - for floor coverings 3 mm. Incl. screws	41,2 x 27,2 mm	250 cm SB	silver	29,00
289 13 14 250	Aluminium stair nosing - countersunk screw holes - for floor coverings 3 mm.	41,2 x 27,2 mm	250 cm	stainless steel matt	31,15

279 13 11 250	Aluminium Stair nosing for insertion - countersunk holes - for floorings 3 - 4 mm.	42,2 x 28,2 mm	250 cm	silver	27,75
---------------	--	----------------	--------	--------	--------------

Schets	Artikelnummer	Omschrijving	Afmeting	Lengte	Kleur	Bruto verkoopprijs / st.
--------	---------------	--------------	----------	--------	-------	--------------------------

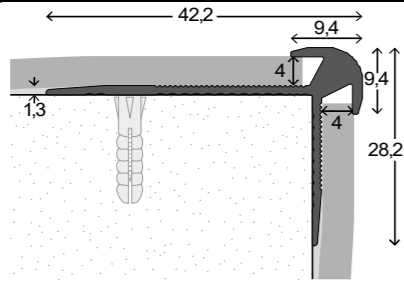

Stair Nosing Inner Angles for Design Floorings

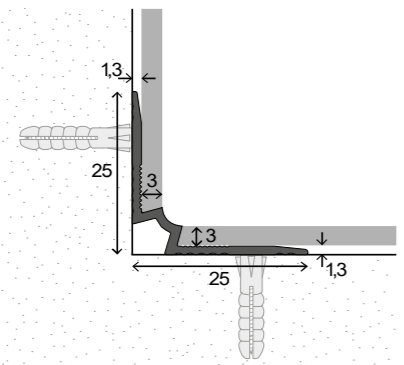

107 13 11 250	Aluminium Stair nosing Inner angle - countersunk screw holes on both sides - for 3,0 mm	25 x 25 mm	250 cm	silver	19,15
107 13 14 250	Aluminium Stair nosing Inner angle - countersunk screw holes on both sides - for 3,0 mm	25 x 25 mm	250 cm	stainless steel matt	21,25

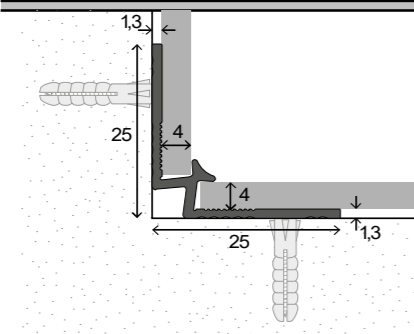

108 13 11 250	Alu-Stair nosing Inner angle with insert - countersunk screw holes on both sides - for 3,2	25 x 25 mm	250 cm	silver	20,40
---------------	--	------------	--------	--------	--------------

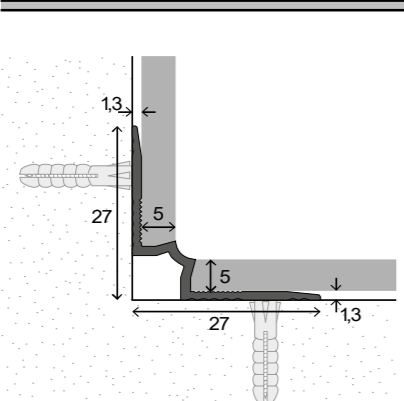

106 13 13 250	Aluminium Stair nosing Inner angle - countersunk screw holes on both sides - for 5,0 mm	27 x 27 mm	250 cm	sahara	21,40
106 13 11 250	Aluminium Stair nosing Inner angle - countersunk screw holes on both sides - for 5,0 mm	27 x 27 mm	250 cm	silver	19,75
106 13 14 250	Aluminium Stair nosing Inner angle - countersunk screw holes on both sides - for 5,0 mm	27 x 27 mm	250 cm	stainless steel matt	21,90

Schets	Artikelnummer	Omschrijving	Afmeting	Lengte	Kleur	Bruto verkoopprijs / st.
	271 63 11 300	Aluminium Stair nosing with insert - countersunk holes - for floorings up to 3 mm.	13,7 x 44,6 mm	300 cm S	silver	25,50
	271 63 14 300	Aluminium Stair nosing with insert - countersunk holes - for floorings up to 3 mm.	13,7 x 44,6 mm	300 cm S	stainless steel matt	27,60
	271 63 32 300	Aluminium Stair nosing with insert - countersunk holes - for floorings up to 3 mm.	13,7 x 44,6 mm	300 cm	black powd. (RAL 9005)	27,75

Schets	Artikelnummer	Omschrijving	Afmeting	Lengte	Kleur	Bruto verkoopprijs / st.
	276 63 11 300	Aluminium Stair nosing for insertion - countersunk holes - for floorings 7 - 10 mm.	21,6 x 51,5 mm	300 cm	silver	43,80
	276 63 14 300	Aluminium Stair nosing for insertion - countersunk holes - for floorings 7 - 10 mm.	21,6 x 51,5 mm	300 cm	stainless steel matt	49,35
	276 63 32 300	Aluminium Stair nosing for insertion - countersunk holes - for floorings 7 - 10 mm.	21,6 x 51,5 mm	300 cm	black powd. (RAL 9005)	54,30

Stair Nosings

	177 13 11 250	Aluminium Stair nosing - countersunk screw holes - for floor coverings 2,5 - 3 mm.	29 x 13 mm	250 cm	silver	18,40
	177 13 11 100	Aluminium Stair nosing - countersunk screw holes - for floor coverings 2,5 - 3 mm.	29 x 13 mm	100 cm SB	silver	8,70
	177 13 14 250	Aluminium Stair nosing - countersunk screw holes - for floor coverings 2,5 - 3 mm.	29 x 13 mm	250 cm	stainless steel matt	20,90
	177 13 14 100	Aluminium Stair nosing - countersunk screw holes - for floor coverings 2,5 - 3 mm.	29 x 13 mm	100 cm SB	stainless steel matt	9,70
	176 13 10 250	Aluminium Stair nosing - countersunk screw holes - for floor coverings 4,5 - 5 mm.	29 x 15 mm	250 cm	gold	22,40
	176 13 10 100	Aluminium Stair nosing - countersunk screw holes - for floor coverings 4,5 - 5 mm.	29 x 15 mm	100 cm SB	gold	10,35
	176 13 11 500	Aluminium Stair nosing - countersunk screw holes - for floor coverings 4,5 - 5 mm.	29 x 15 mm	500 cm	silver	Op aanvraag
	176 13 11 250	Aluminium Stair nosing - countersunk screw holes - for floor coverings 4,5 - 5 mm.	29 x 15 mm	250 cm	silver	20,50
	176 13 11 100	Aluminium Stair nosing - countersunk screw holes - for floor coverings 4,5 - 5 mm.	29 x 15 mm	100 cm SB	silver	9,50
	176 13 14 250	Aluminium Stair nosing - countersunk screw holes - for floor coverings 4,5 - 5 mm.	29 x 15 mm	250 cm	stainless steel matt	23,75
	176 13 14 100	Aluminium Stair nosing - countersunk screw holes - for floor coverings 4,5 - 5 mm.	29 x 15 mm	100 cm SB	stainless steel matt	10,90
	270 13 11 250	Aluminium Stair nosing - countersunk screw holes - for covering thicknesses 8 - 9 mm.	38 x 36,4 mm	250 cm	silver	35,65
	270 13 11 100	Aluminium Stair nosing - countersunk screw holes - for covering thicknesses 8 - 9 mm.	38 x 36,4 mm	100 cm	silver	15,05
	270 13 14 250	Aluminium Stair nosing - countersunk screw holes - for covering thicknesses 8 - 9 mm.	38 x 36,4 mm	250 cm	stainless steel matt	40,25
	274 13 11 250	Aluminium Stair nosing - screw holes on both sides - for covering thicknesses 9 - 10 mm	38 x 36,4mm	250 cm	silver	36,75
	274 13 14 250	Aluminium Stair nosing - screw holes on both sides - for covering thicknesses 9 - 10 mm	38 x 36,4mm	250 cm	stainless steel matt	42,15
	272 13 13 250	Aluminium Stair nosing - countersunk screw holes - for covering thicknesses 8 - 9 mm.	35 x 20 mm	250 cm	sahara	28,50
	272 13 11 250	Aluminium Stair nosing - countersunk screw holes - for covering thicknesses 8 - 9 mm.	35 x 20 mm	250 cm	silver	25,75
	272 13 11 100	Aluminium Stair nosing - countersunk screw holes - for covering thicknesses 8 - 9 mm.	35 x 20 mm	100 cm SB	silver	11,35
	272 13 14 250	Aluminium Stair nosing - countersunk screw holes - for covering thicknesses 8 - 9 mm.	35 x 20 mm	250 cm	stainless steel matt	30,50

Schets	Artikelnummer	Omschrijving	Afmeting	Lengte	Kleur	Bruto verkoopprijs / st.
--------	---------------	--------------	----------	--------	-------	--------------------------

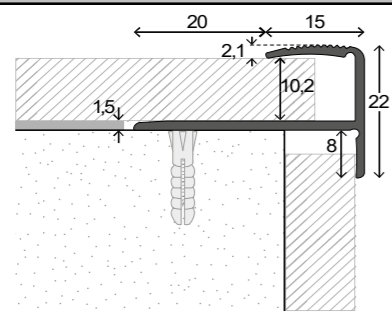

275 13 11 250	Aluminium Stair nosing - countersunk screw holes - for covering thicknesses 10 - 11 mm	35 x 22 mm	250 cm	silver	26,65
275 13 14 250	Aluminium Stair nosing - countersunk screw holes - for covering thicknesses 10 - 11 mm	35 x 22 mm	250 cm	stainless steel matt	31,65

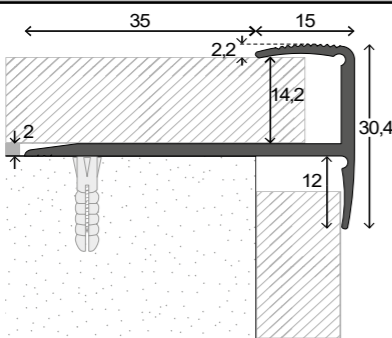

273 13 10 250	Aluminium Stair nosing - countersunk screw holes - for covering thicknesses 13 - 15 mm	50 x 30,4 mm	250 cm	gold	41,25
273 13 11 250	Aluminium Stair nosing - countersunk screw holes - for covering thicknesses 13 - 15 mm	50 x 30,4 mm	250 cm	silver	38,15
273 13 14 250	Aluminium Stair nosing - countersunk screw holes - for covering thicknesses 13 - 15 mm	50 x 30,4 mm	250 cm	stainless steel matt	43,50

Stair levelling angle

834 10 00 100	Stair levelling angle H 20, incl. screw nails.	42 x 20 mm	100 cm		5,20
---------------	--	------------	--------	--	-------------

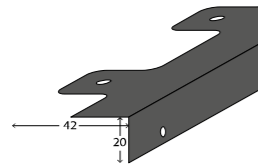

Article not available when opened.

834 20 00 100	Stair levelling angle H 38 incl. screw nails.	42 x 38 mm	100 cm		6,15
---------------	---	------------	--------	--	-------------

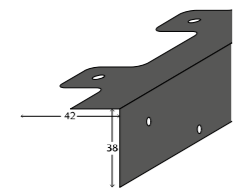

Article not available when opened.

834 30 00 100	Stair levelling angle S 20, incl. screws and plugs.	42 x 20 mm	100 cm		6,10
---------------	---	------------	--------	--	-------------

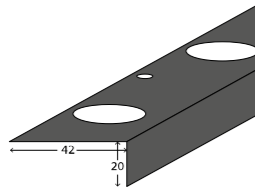

Article not available when opened.

PVC-Profiles

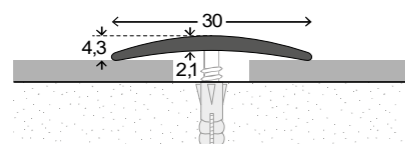

800 20 40 100	Rigid PVC Connection section - centre holes.	30 mm	100 cm SB	brown	3,05
800 20 41 100	Rigid PVC Connection section - centre holes.	30 mm	100 cm SB	beige	3,05
800 20 42 100	Rigid PVC Connection section - centre holes.	30 mm	100 cm SB	grey	3,05
800 20 32 100	Rigid PVC Connection section - centre holes.	30 mm	100 cm SB	black	3,05

Schets	Artikelnummer	Omschrijving	Afmeting	Lengte	Kleur	Bruto verkoopprijs / st.
--------	---------------	--------------	----------	--------	-------	--------------------------

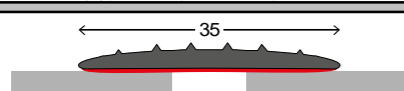

800 10 40 100	Soft PVC Connection section - auto-adhesive.	35 mm	100 cm SB	brown	5,65
800 10 41 100	Soft PVC Connection section - auto-adhesive.	35 mm	100 cm SB	beige	5,65
800 10 42 100	Soft PVC Connection section - auto-adhesive.	35 mm	100 cm SB	grey	5,65
800 10 32 100	Soft PVC Connection section - auto-adhesive.	35 mm	100 cm SB	black	5,65

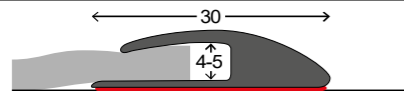

801 10 40 100	Soft PVC Border section - one-sided - auto-adhesive.	30 mm	100 cm SB	brown	5,65
801 10 41 100	Soft PVC Border section - one-sided - auto-adhesive.	30 mm	100 cm SB	beige	5,65
801 10 42 100	Soft PVC Border section - one-sided - auto-adhesive.	30 mm	100 cm SB	grey	5,65
801 10 32 100	Soft PVC Border section - one-sided - auto-adhesive.	30 mm	100 cm SB	black	5,65

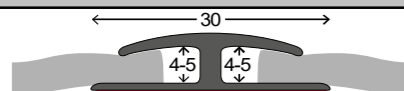

801 20 40 100	Soft PVC Border section - insert on both sides - auto-adhesive.	30 mm	100 cm SB	brown	5,65
801 20 41 100	Soft PVC Border section - insert on both sides - auto-adhesive.	30 mm	100 cm SB	beige	5,65
801 20 42 100	Soft PVC Border section - insert on both sides - auto-adhesive.	30 mm	100 cm SB	grey	5,65
801 20 32 100	Soft PVC Border section - insert on both sides - auto-adhesive.	30 mm	100 cm SB	black	5,65

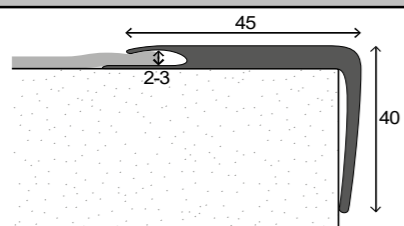

802 10 40 270	Soft PVC Stair nosing - without screw holes - for flooring covering thicknesses 2 - 3 mm.	45 x 40 mm	270 cm	brown	20,25
802 10 41 270	Soft PVC Stair nosing - without screw holes - for flooring covering thicknesses 2 - 3 mm.	45 x 40 mm	270 cm	beige	20,25
802 10 42 270	Soft PVC Stair nosing - without screw holes - for flooring covering thicknesses 2 - 3 mm.	45 x 40 mm	270 cm	grey	20,25
802 10 32 270	Soft PVC Stair nosing - without screw holes - for flooring covering thicknesses 2 - 3 mm.	45 x 40 mm	270 cm	black	20,25

Door Bottom Sealant

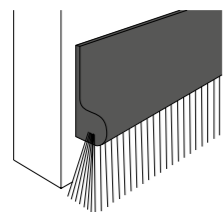

806 10 30 100	Door bottom sealant - auto-adhesive.	5 x 30 mm	100 cm SB	white	6,90
806 10 40 100	Door bottom sealant - auto-adhesive.	5 x 30 mm	100 cm SB	brown	6,90
806 10 20 100	Door bottom sealant - auto-adhesive.	5 x 30 mm	100 cm SB	beech	7,00
806 10 49 100	Door bottom sealant - auto-adhesive.	5 x 30 mm	100 cm SB	light oak	7,00
806 10 51 100	Door bottom sealant - auto-adhesive.	5 x 30 mm	100 cm SB	walnut	7,00
806 10 67 100	Door bottom sealant - auto-adhesive.	5 x 30 mm	100 cm SB	transparent	7,00

MuraTec Wall profile system

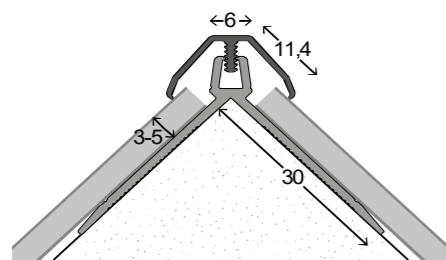

960 20 11 260	Aluminium exterior angle - two-piece - for covering thicknesses 3.0 - 5.0 mm	28 mm	260 cm	silver	22,50
960 20 19 260	Aluminium exterior angle - two-piece - for covering thicknesses 3.0 - 5.0 mm	28 mm	260 cm	stainless steel brushed	26,95
960 20 32 260	Aluminium exterior angle - two-piece - for covering thicknesses 3.0 - 5.0 mm	28 mm	260 cm	black powd, (RAL 9005)	24,45

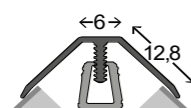

961 20 11 260	Aluminium exterior angle - two-piece - for covering thicknesses 6.0 - 9.0 mm	32 mm	260 cm	silver	23,40
961 20 19 260	Aluminium exterior angle - two-piece - for covering thicknesses 6.0 - 9.0 mm	32 mm	260 cm	stainless steel brushed	28,25
961 20 32 260	Aluminium exterior angle - two-piece - for covering thicknesses 6.0 - 9.0 mm	32 mm	260 cm	black powd, (RAL 9005)	26,15

Schets	Artikelnummer	Omschrijving	Afmeting	Lengte	Kleur	Bruto verkoopprijs / st.
--------	---------------	--------------	----------	--------	-------	--------------------------

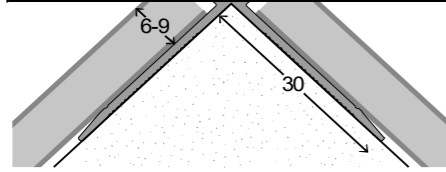

962 20 11 260	Aluminium inner angle - two-piece - for covering thicknesses 3.0 - 5.0 mm	13,5 mm	260 cm	silver	19,80
962 20 19 260	Aluminium inner angle - two-piece - for covering thicknesses 3.0 - 5.0 mm	13,5 mm	260 cm	stainless steel brushed	23,30
962 20 32 260	Aluminium inner angle - two-piece - for covering thicknesses 3.0 - 5.0 mm	13,5 mm	260 cm	black powd, (RAL 9005)	21,85

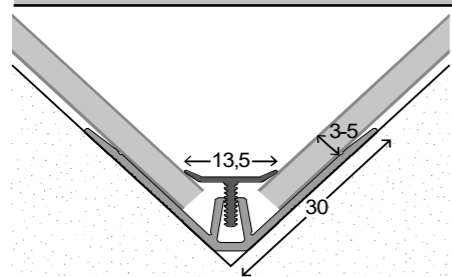

963 20 11 260	Aluminium inner angle - two-piece - for covering thicknesses 6.0 - 9.0 mm	13,5 mm	260 cm	silver	20,80
963 20 19 260	Aluminium inner angle - two-piece - for covering thicknesses 6.0 - 9.0 mm	13,5 mm	260 cm	stainless steel brushed	24,70
963 20 32 260	Aluminium inner angle - two-piece - for covering thicknesses 6.0 - 9.0 mm	13,5 mm	260 cm	black powd, (RAL 9005)	23,30

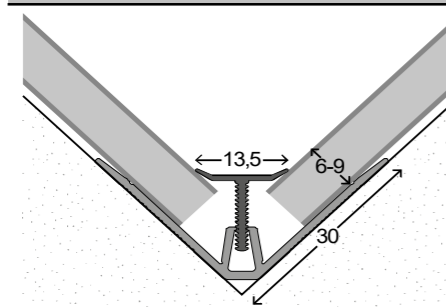

964 20 11 260	Aluminium connection section - two-piece - for covering thicknesses 3.0 - 5.0 mm	14 mm	260 cm	silver	16,80
964 20 19 260	Aluminium connection section - two-piece - for covering thicknesses 3.0 - 5.0 mm	14 mm	260 cm	stainless steel brushed	20,15
964 20 32 260	Aluminium connection section - two-piece - for covering thicknesses 3.0 - 5.0 mm	14 mm	260 cm	black powd, (RAL 9005)	18,50

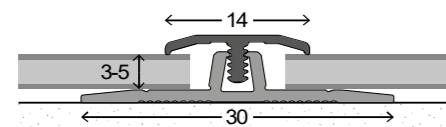

965 20 11 260	Aluminium connection section - two-piece - for covering thicknesses 6.0 - 9.0 mm	14 mm	260 cm	silver	17,45
965 20 19 260	Aluminium connection section - two-piece - for covering thicknesses 6.0 - 9.0 mm	14 mm	260 cm	stainless steel brushed	20,55
965 20 32 260	Aluminium connection section - two-piece - for covering thicknesses 6.0 - 9.0 mm	14 mm	260 cm	black powd, (RAL 9005)	19,15

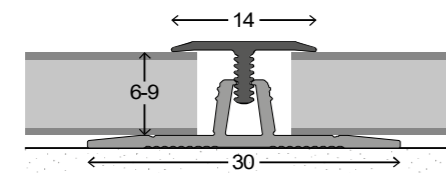

Profiles for wall panels

211 20 11 270	Aluminium Border section- without screw holes - for covering thicknesses 2,5 - 3,0 mm.	27 x 5,4 mm	270 cm S	silver	14,85
211 20 19 270	Aluminium Border section- without screw holes - for covering thicknesses 2,5 - 3,0 mm.	27 x 5,4 mm	270 cm S	stainless steel brushed	18,40
211 20 32 270	Aluminium Border section- without screw holes - for covering thicknesses 2,5 - 3,0 mm.	27 x 5,4 mm	270 cm S	black powd, (RAL 9005)	17,45

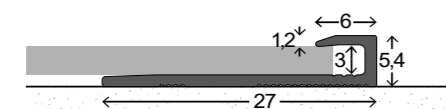

212 20 11 270	Aluminium Border section- without screw holes - for covering thicknesses 3,5 - 4,0 mm.	27 x 6,4 mm	270 cm S	silver	15,40
212 20 19 270	Aluminium Border section- without screw holes - for covering thicknesses 3,5 - 4,0 mm.	27 x 6,4 mm	270 cm S	stainless steel brushed	18,90

Schets	Artikelnummer	Omschrijving	Afmeting	Lengte	Kleur	Bruto verkoopprijs / st.	
	212 20 32 270	Aluminium Border section- without screw holes - for covering thicknesses 3,5 - 4,0 mm.	27 x 6,4 mm	270 cm S	black powd, (RAL 9005)	18,00	
		143 20 11 270	Aluminium Border section- without screw holes - for covering thicknesses 4,5 - 5,0 mm.	27 x 7,4 mm	270 cm S	silver	16,65
		143 20 19 270	Aluminium Border section- without screw holes - for covering thicknesses 4,5 - 5,0 mm.	27 x 7,4 mm	270 cm S	stainless steel brushed	20,25
143 20 32 270		Aluminium Border section- without screw holes - for covering thicknesses 4,5 - 5,0 mm.	27 x 7,4 mm	270 cm S	black powd, (RAL 9005)	19,35	
	144 20 11 270	Aluminium Border section- without screw holes - for covering thicknesses 5,5 - 6,0 mm.	27 x 8,4 mm	270 cm S	silver	16,90	
	144 20 19 270	Aluminium Border section- without screw holes - for covering thicknesses 5,5 - 6,0 mm.	27 x 8,4 mm	270 cm S	stainless steel brushed	20,55	
	144 20 32 270	Aluminium Border section- without screw holes - for covering thicknesses 5,5 - 6,0 mm.	27 x 8,4 mm	270 cm S	black powd, (RAL 9005)	19,75	
	147 20 11 270	Aluminium Border section- without screw holes - for covering thicknesses 6,5 - 7,0 mm.	27 x 9,4 mm	270 cm S	silver	17,15	
	147 20 19 270	Aluminium Border section- without screw holes - for covering thicknesses 6,5 - 7,0 mm.	27 x 9,4 mm	270 cm S	stainless steel brushed	20,80	
	147 20 32 270	Aluminium Border section- without screw holes - for covering thicknesses 6,5 - 7,0 mm.	27 x 9,4 mm	270 cm S	black powd, (RAL 9005)	20,00	
	149 20 11 270	Aluminium Border section- without screw holes - for covering thicknesses 7,5 - 8,0 mm.	27 x 10,4 mm	270 cm S	silver	17,45	
	149 20 19 270	Aluminium Border section- without screw holes - for covering thicknesses 7,5 - 8,0 mm.	27 x 10,4 mm	270 cm S	stainless steel brushed	21,20	
	149 20 32 270	Aluminium Border section- without screw holes - for covering thicknesses 7,5 - 8,0 mm.	27 x 10,4 mm	270 cm S	black powd, (RAL 9005)	20,25	
	152 20 11 270	Aluminium Border section- without screw holes - for covering thicknesses 8,5 - 9,0 mm.	27 x 11,4 mm	270 cm S	silver	17,85	
	152 20 19 270	Aluminium Border section- without screw holes - for covering thicknesses 8,5 - 9,0 mm.	27 x 11,4 mm	270 cm S	stainless steel brushed	21,60	
	152 20 32 270	Aluminium Border section- without screw holes - for covering thicknesses 8,5 - 9,0 mm.	27 x 11,4 mm	270 cm S	black powd, (RAL 9005)	20,80	
	950 20 11 260	Aluminium Border section - unperforated - for wall panel thicknesses up to 4,5 mm	27 x 7,1 mm	260 cm	silver	15,50	
	950 20 32 260	Aluminium Border section - unperforated - for wall panel thicknesses up to 4,5 mm	27 x 7,1 mm	260 cm	black powd. (RAL 9005)	17,95	
	950 20 34 260	Aluminium Border section - unperforated - for wall panel thicknesses up to 4,5 mm	27 x 7,1 mm	260 cm	signal white powd. (RAL 9003)	17,95	
	951 20 11 260	Aluminium Border section - unperforated - for wall panel thicknesses up to 4,5 mm	27 x 6,7 mm	260 cm	silver	14,70	
	951 20 32 260	Aluminium Border section - unperforated - for wall panel thicknesses up to 4,5 mm	27 x 6,7 mm	260 cm	black powd. (RAL 9005)	16,90	
	951 20 34 260	Aluminium Border section - unperforated - for wall panel thicknesses up to 4,5 mm	27 x 6,7 mm	260 cm	signal white powd. (RAL 9003)	16,90	

Schets	Artikelnummer	Omschrijving	Afmeting	Lengte	Kleur	Bruto verkoopprijs / st.
	952 20 11 260	Aluminium Connection section - unperforated - for wall panel thicknesses up to 4,5 mm	6,4 mm	260 cm	silver	15,50
	952 20 32 260	Aluminium Connection section - unperforated - for wall panel thicknesses up to 4,5 mm	6,4 mm	260 cm	black powd. (RAL 9005)	17,95
	952 20 34 260	Aluminium Connection section - unperforated - for wall panel thicknesses up to 4,5 mm	6,4 mm	260 cm	signal white powd. (RAL 9003)	17,95

	954 20 11 260	Aluminium Connection section - unperforated - for wall panel thicknesses up to 4,5 mm	10 mm	260 cm	silver	16,25
	954 20 32 260	Aluminium Connection section - unperforated - for wall panel thicknesses up to 4,5 mm	10 mm	260 cm	black powd. (RAL 9005)	18,85
	954 20 34 260	Aluminium Connection section - unperforated - for wall panel thicknesses up to 4,5 mm	10 mm	260 cm	signal white powd. (RAL 9003)	18,85

	955 20 11 260	Aluminium outer angle - unperforated - for wall panel thicknesses up to 4,5 mm	26,2 x 26,2 mm	260 cm	silver	21,20
	955 20 32 260	Aluminium outer angle - unperforated - for wall panel thicknesses up to 4,5 mm	26,2 x 26,2 mm	260 cm	black powd. (RAL 9005)	24,45
	955 20 34 260	Aluminium outer angle - unperforated - for wall panel thicknesses up to 4,5 mm	26,2 x 26,2 mm	260 cm	signal white powd. (RAL 9003)	24,45

	956 20 11 260	Aluminium outer angle - unperforated - for wall panel thicknesses up to 4,5 mm	28,6 x 28,6 mm	260 cm	silver	28,25
	956 20 32 260	Aluminium outer angle - unperforated - for wall panel thicknesses up to 4,5 mm	28,6 x 28,6 mm	260 cm	black powd. (RAL 9005)	32,25
	956 20 34 260	Aluminium outer angle - unperforated - for wall panel thicknesses up to 4,5 mm	28,6 x 28,6 mm	260 cm	signal white powd. (RAL 9003)	32,25

	953 20 11 260	Aluminium Inner angle - unperforated - for wall panel thicknesses up to 4,5 mm	20,2 x 20,2 mm	260 cm	silver	17,20
	953 20 32 260	Aluminium Inner angle - unperforated - for wall panel thicknesses up to 4,5 mm	20,2 x 20,2 mm	260 cm	black powd. (RAL 9005)	19,80
	953 20 34 260	Aluminium Inner angle - unperforated - for wall panel thicknesses up to 4,5 mm	20,2 x 20,2 mm	260 cm	signal white powd. (RAL 9003)	19,80

	957 20 11 260	Aluminium Inner angle - unperforated - for wall panel thicknesses up to 4,5 mm	25,5 x 25,5 mm	260 cm	silver	20,15
	957 20 32 260	Aluminium Inner angle - unperforated - for wall panel thicknesses up to 4,5 mm	25,5 x 25,5 mm	260 cm	black powd. (RAL 9005)	23,30
	957 20 34 260	Aluminium Inner angle - unperforated - for wall panel thicknesses up to 4,5 mm	25,5 x 25,5 mm	260 cm	signal white powd. (RAL 9003)	23,30

Corner Protective Angle						
	283 10 02 250	Stainless steel Corner protective angle, folded three times - without screw holes.	20 x 20 mm	250 cm	stainless steel brushed	37,15

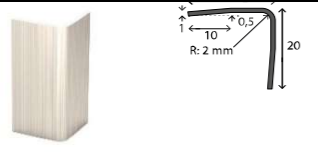
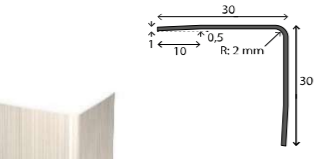
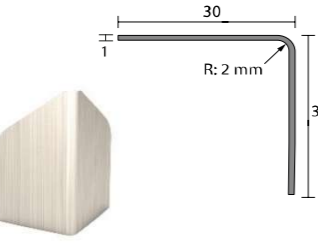
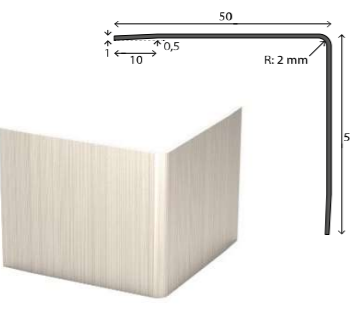
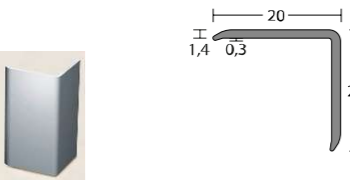
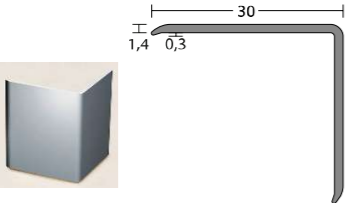
Schets	Artikelnummer	Omschrijving	Afmeting	Lengte	Kleur	Bruto verkoopprijs / st.
	283 20 02 150	Stainless steel Corner protective angle, folded once - without screw holes, with crown.	20 x 20 mm	150 cm	stainless steel brushed	27,70
	284 10 02 250	Stainless steel Corner protective angle, folded three times - without screw holes.	30 x 30 mm	250 cm	stainless steel brushed	39,65
	284 20 02 150	Stainless steel Corner protective angle, folded once - without screw holes, with crown.	30 x 30 mm	150 cm	stainless steel brushed	33,00
	285 10 02 250	Stainless steel Corner protective angle, folded three times - without screw holes.	50 x 50 mm	250 cm	stainless steel brushed	51,00
	280 10 11 250	Aluminium Corner protective angle	20 x 20 mm	250 cm	silver	13,25
	280 10 11 150	Aluminium Corner protective angle	20 x 20 mm	150 cm	silver	9,75
	281 10 11 250	Aluminium Corner protective angle	30 x 30 mm	250 cm	silver	18,00
	281 10 11 150	Aluminium Corner protective angle	30 x 30 mm	150 cm	silver	12,85

Schets	Artikelnummer	Omschrijving	Afmeting	Lengte	Kleur	Bruto verkoopprijs / st.
	282 10 11 250	Aluminium Corner protective angle	50 x 50 mm	250 cm	silver	27,25
	282 10 11 150	Aluminium Corner protective angle	50 x 50 mm	150 cm	silver	18,40

Rigid PVC Angle						
	804 20 30 250	Rigid PVC Angle - without screw holes.	20 x 20 mm	250 cm	white	4,90
	804 20 20 250	Rigid PVC Angle - without screw holes.	20 x 20 mm	250 cm	beech	5,15
	804 20 25 250	Rigid PVC Angle - without screw holes.	20 x 20 mm	250 cm	oak	5,15

	804 30 30 250	Rigid PVC Angle - without screw holes.	30 x 30 mm	250 cm	white	6,65
	804 30 20 250	Rigid PVC Angle - without screw holes.	30 x 30 mm	250 cm	beech	7,00
	804 30 25 250	Rigid PVC Angle - without screw holes.	30 x 30 mm	250 cm	oak	7,00

Dry Construction Angle						
	805 90 30 260	Rigid PVC Dry construction angle edge - without screw holes.	20 x 20 mm	260 cm	white	5,75

Aluminium-Clip-Skirting Boards						
	359 10 11 400	Aluminium clip skirting board	10 x 60 mm	400 cm	silver	54,20
	100 fixing clips included in the price (2,5 clips per m). Enclosed separately.					
	359 10 32 400	Aluminium clip skirting board	10 x 60 mm	400 cm	black powd. (RAL 9005)	77,60

	361 10 11 400	Aluminium clip skirting board	10 x 70 mm	400 cm	silver	58,40
--	---------------	-------------------------------	------------	--------	--------	--------------

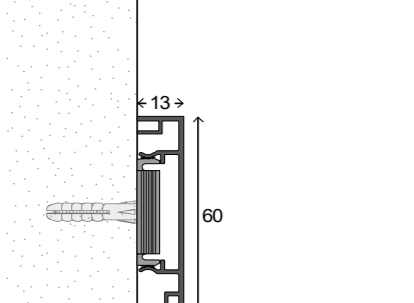
Schets	Artikelnummer	Omschrijving	Afmeting	Lengte	Kleur	Bruto verkoopprijs / st.
	363 10 11 400	Aluminium clip skirting board	10 x 80 mm	400 cm	silver	62,80
	364 10 11 400	Aluminium clip skirting board	10 x 100 mm	400 cm	silver	75,40
	354 10 11 400	Aluminium clip skirting board 100 fixing clips included in the price (2,5 clips per m). Enclosed separately.	13 x 60 mm	400 cm	silver	57,20
	353 10 11 400	Aluminium clip skirting board	13 x 70 mm	400 cm	silver	61,80

Schets	Artikelnummer	Omschrijving	Afmeting	Lengte	Kleur	Bruto verkoopprijs / st.
--------	---------------	--------------	----------	--------	-------	--------------------------

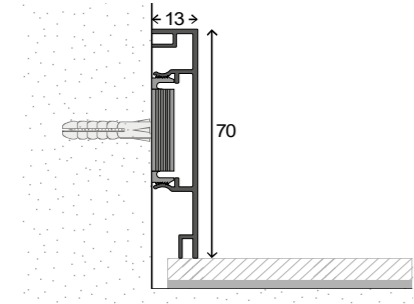

355 10 11 400	Aluminium clip skirting board	13 x 80 mm	400 cm	silver	66,20
---------------	-------------------------------	------------	--------	--------	--------------

100 fixing clips included in the price (2,5 clips per m). Enclosed separately.

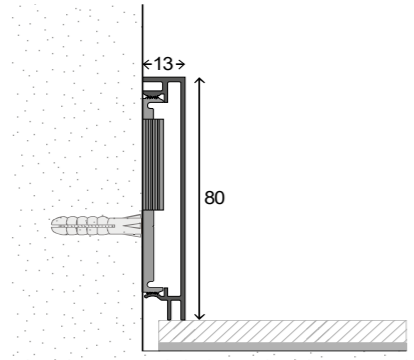

356 10 11 400	Aluminium clip skirting board	13 x 100 mm	400 cm	silver	78,80
---------------	-------------------------------	-------------	--------	--------	--------------

100 fixing clips included in the price (2,5 clips per m). Enclosed separately.

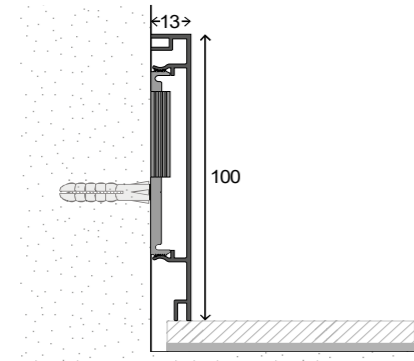

Aluminium-LED-Skirting Boards

357 10 11 400	Aluminium clip skirting board. Incl. Clips (2,5 pcs. / m) and LED diffuser.	13 x 80 mm	400 cm	silver	89,00
---------------	---	------------	--------	--------	--------------

100 fixing clips included in the price (2,5 clips per m). Enclosed separately.

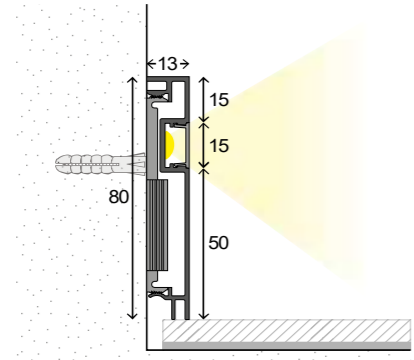

358 10 11 400	Aluminium LED skirting board, indirect illumination downward. Incl. Clips (2,5 pcs. / m).	13 x 80 mm	400 cm	silver	75,80
---------------	---	------------	--------	--------	--------------

100 fixing clips included in the price (2,5 clips per m). Enclosed separately.

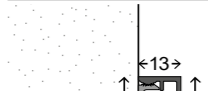

Schets	Artikelnummer	Omschrijving	Afmeting	Lengte	Kleur	Bruto verkoopprijs / st.
--------	---------------	--------------	----------	--------	-------	--------------------------

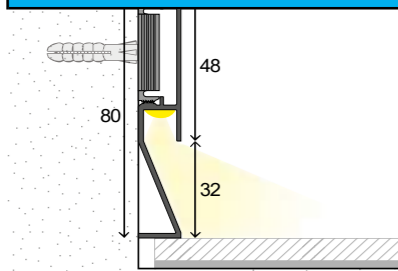

Accessories for Aluminim-Clip-Skirting Boards



359 01 11 000	Inner corner for skirting board no. 359	10 x 60 mm	25 cm	silver	29,75
359 01 32 000	Inner corner for skirting board no. 359	10 x 60 mm	25 cm	black powd. (RAL 9005)	31,20
361 01 11 000	Inner corner for skirting board no.361	10 x 70 mm	25 cm	silver	30,35
363 01 11 000	Inner corner for skirting board no.363	10 x 80 mm	25 cm	silver	31,05
364 01 11 000	Inner corner for skirting board no.364	10 x 100 mm	25 cm	silver	33,10

354 01 11 000	Inner corner for skirting board no. 354	13 x 60 mm	25 cm	silver	30,15
353 01 11 000	Inner corner for skirting board no.353	13 x 70 mm	25 cm	silver	30,95
355 01 11 000	Inner corner for skirting board no. 355	13 x 80 mm	25 cm	silver	31,35
356 01 11 000	Inner corner for skirting board no. 356	13 x 100 mm	25 cm	silver	33,20
357 01 11 000	Inner corner for skirting board no. 357	13 x 80 mm	25 cm	silver	33,20
358 01 11 000	Inner corner for skirting board no. 358	13 x 80 mm	25 cm	silver	33,20



359 02 11 000	Outer corner for skirting board no. 359	10 x 60 mm	25 cm	silver	29,75
359 02 32 000	Outer corner for skirting board no. 359	10 x 60 mm	25 cm	black powd. (RAL 9005)	31,20
361 02 11 000	Outer corner for skirting board no. 361	10 x 70 mm	25 cm	silver	30,35
363 02 11 000	Outer corner for skirting board no. 363	10 x 80 mm	25 cm	silver	31,05
364 02 11 000	Outer corner for skirting board no. 364	10 x 100 mm	25 cm	silver	33,10

354 02 11 000	Outer corner for skirting board no. 354	13 x 60 mm	25 cm	silver	30,15
353 02 11 000	Outer corner for skirting board no. 353	13 x 70 mm	25 cm	silver	30,95
355 02 11 000	Outer corner for skirting board no. 355	13 x 80 mm	25 cm	silver	31,35
356 02 11 000	Outer corner for skirting board no. 356	13 x 100 mm	25 cm	silver	33,20
357 02 11 000	Outer corner for skirting board no. 357	13 x 80 mm	25 cm	silver	33,20
358 02 11 000	Outer corner for skirting board no. 358	13 x 80 mm	25 cm	silver	33,20



359 03 11 000	End cap for skirting board no. 359	10 x 60 mm		silver	10,10
359 03 32 000	End cap for skirting board no. 359	10 x 60 mm		black powd. (RAL 9005)	10,60
361 03 11 000	End cap for skirting board no. 361	10 x 70 mm		silver	10,10
363 03 11 000	End cap for skirting board no. 363	10 x 80 mm		silver	10,10
364 03 11 000	End cap for skirting board no. 364	10 x 100 mm		silver	10,10

354 03 11 000	End cap for skirting board no. 354	13 x 60 mm		silver	10,10
353 03 11 000	End cap for skirting board no. 353	13 x 70 mm		silver	10,10
355 03 11 000	End cap for skirting board no. 355, 357, 358	13 x 80 mm		silver	10,10
356 03 11 000	End cap for skirting board no. 356	13 x 100 mm		silver	10,10

354 00 00 000	PVC Clip for aluminium wall skirting board	64 x 32 mm			1,05
---------------	--	------------	--	--	-------------

Schets	Artikelnummer	Omschrijving	Afmeting	Lengte	Kleur	Bruto verkoopprijs / st.
--------	---------------	--------------	----------	--------	-------	--------------------------

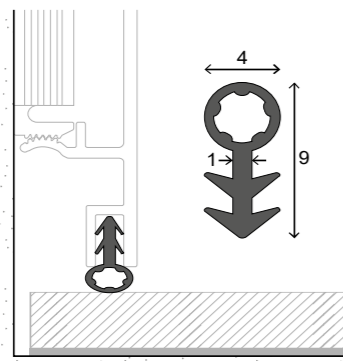
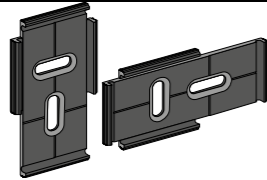

354 10 01 000	Sealing lip	4 mm	100 m	transparent	165,00
354 10 02 000	Sealing lip	4 mm	100 m	white	165,00
354 10 03 000	Sealing lip	4 mm	100 m	light grey	165,00

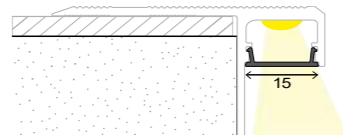

354 20 00 400	LED Diffusor (cover cap) - PET	15 mm	400 cm	translucent	21,20
354 20 00 250	LED Diffusor (cover cap) - PET	15 mm	250 cm	translucent	13,90

Aluminium-Angle Skirting with reversing function

- > Aluminium-Angl skirting with reversing function
- > Short branch downward = Aluminium-Skirting Board in modern metal visual appearance.
- > Short branch upward = Skirting board for glueing-in of floor coverings up to 3,5 mm / 6,5 mm / 13 mm thickness.
- > Glue-in skirting boards can be used to efficiently and cost-effectively create skirting boards with identical decor from surplus flooring.

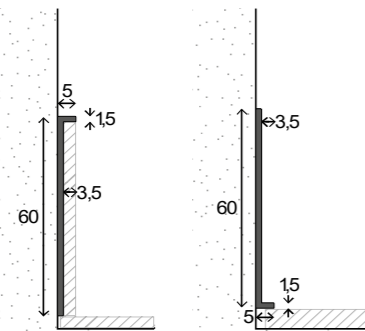

375 10 11 500	Aluminium Angle skirting - for floorings up to 3,5 mm.	5 x 60 mm	500 cm	silver	Op aanvraag
375 10 11 250	Aluminium Angle skirting - for floorings up to 3,5 mm.	5 x 60 mm	250 cm S	silver	21,25

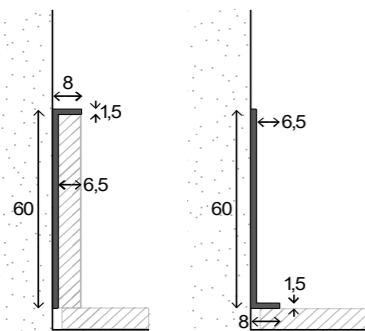

376 10 11 500	Aluminium Angle skirting - for floorings up to 6,5 mm.	8 x 60 mm	500 cm	silver	Op aanvraag
376 10 11 250	Aluminium Angle skirting - for floorings up to 6,5 mm.	8 x 60 mm	250 cm S	silver	22,25

389 10 11 500	Aluminium Angle skirting - for floorings up to 6 mm. Joint covering 9,5 mm.	9,5 x 60 mm	500 cm	silver	Op aanvraag
389 10 11 250	Aluminium Angle skirting - for floorings up to 6 mm. Joint covering 9,5 mm.	9,5 x 60 mm	250 cm S	silver	24,00

Schets	Artikelnummer	Omschrijving	Afmeting	Lengte	Kleur	Bruto verkoopprijs / st.
--------	---------------	--------------	----------	--------	-------	--------------------------

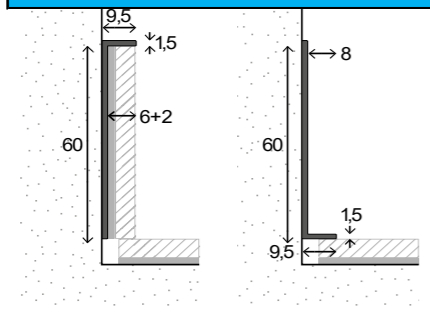

	377 10 11 500	Aluminium Angle skirting - for floorings up to 13 mm	14,5 x 60 mm	500 cm	silver	Op aanvraag
	377 10 11 250	Aluminium Angle skirting - for floorings up to 13 mm	14,5 x 60 mm	250 cm S	silver	24,00

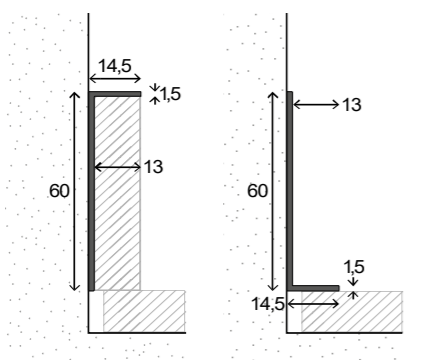

	390 10 11 400	Aluminium Angle skirting - for floorings up to 16 mm.	23,5 x 60 mm	400 cm	silver	54,60
	390 10 32 400	Aluminium Angle skirting - for floorings up to 16 mm.	23,5 x 60 mm	400 cm	black powd. (RAL 9005)	62,00

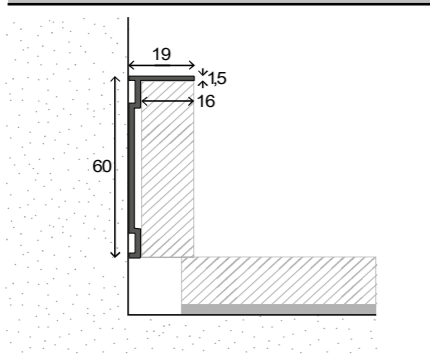

	386 10 11 500	Aluminium Angle skirting - for floorings up to 3,5 mm	5 x 100 mm	500 cm	silver	Op aanvraag
	386 10 11 250	Aluminium Angle skirting - for floorings up to 3,5 mm	5 x 100 mm	250 cm	silver	34,90

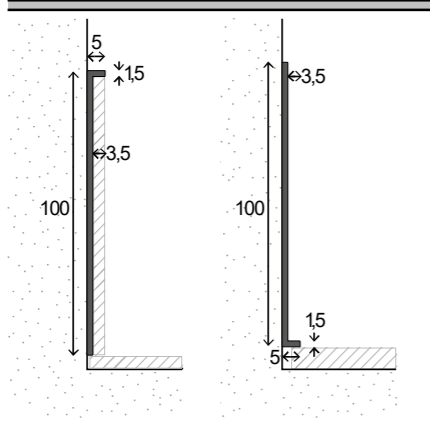

	387 10 11 500	Aluminium Angle skirting - for floorings up to 6,5 mm	8 x 100 mm	500 cm	silver	Op aanvraag
	387 10 11 250	Aluminium Angle skirting - for floorings up to 6,5 mm	8 x 100 mm	250 cm	silver	35,75



Schets	Artikelnummer	Omschrijving	Afmeting	Lengte	Kleur	Bruto verkoopprijs / st.

	388 10 11 500	Aluminium Angle skirting - for floorings up to 13 mm	14,5 x 100 mm	500 cm	silver	Op aanvraag
	388 10 11 250	Aluminium Angle skirting - for floorings up to 13 mm	14,5 x 100 mm	250 cm	silver	37,75

Aluminium-Cove and Cap skirtings

	391 10 06 400	Aluminium Cove and Cap skirting - unperforated - for floor coverings up to 3,5 mm	5,3 x 82 mm	400 cm	aluminium natural	55,20
--	---------------	---	-------------	--------	-------------------	--------------

	392 10 06 400	Aluminium Cove and Cap skirting - unperforated - for floor coverings up to 3,5 mm	5,5 x 102 mm	400 cm	aluminium natural	74,40
--	---------------	---	--------------	--------	-------------------	--------------

Renovation -Skirting to cover existent skirtings made of ceramic tiles

	370 10 11 300	Aluminium-Renovation-skirting - for coverings up to 3 mm	15,3 x 43,5 mm	300 cm	silver	19,50
--	---------------	--	----------------	--------	--------	--------------

Schets	Artikelnummer	Omschrijving	Afmeting	Lengte	Kleur	Bruto verkoopprijs / st.

	369 10 11 300	Aluminium-Renovation-skirting - for coverings 4 - 8 mm	20 x 43 mm	300 cm	silver	22,80
--	---------------	--	------------	--------	--------	--------------

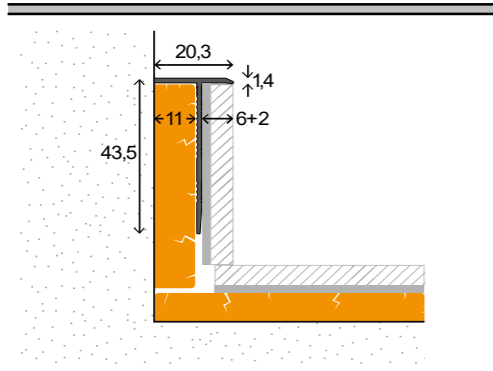

Aluminium-Flat Sections						
	911 10 11 300	Aluminium- Flat section, without screw holes	2 x 60 mm	300 cm	silver	23,40

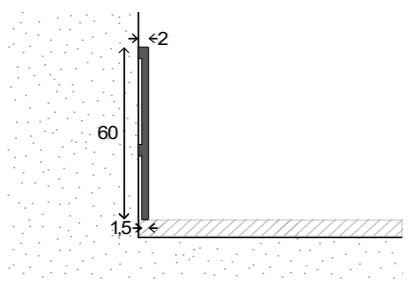

	915 10 11 300	Aluminium- Flat section, without screw holes	2 x 100 mm	300 cm	silver	37,80
--	---------------	--	------------	--------	--------	--------------

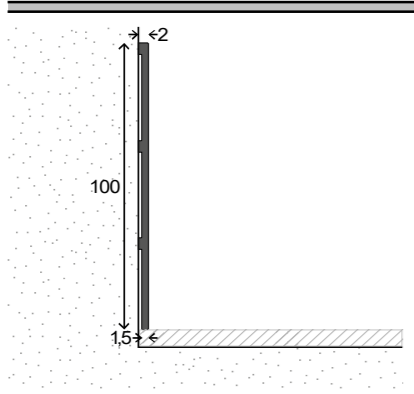

Aluminium Clips Skirting Board "Cultus45"						
---	--	--	--	--	--	--

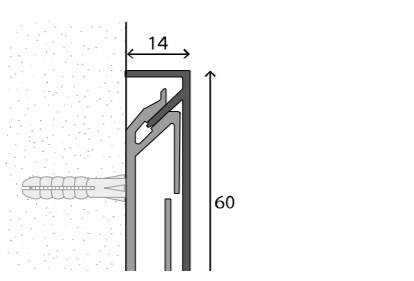

- > Aluminium clips skirting board for innovative mounting at 45 degree angle
- > Saves wall and floor area
- > Floor covering width 14 mm
- > Large trap to cover cable routing
- > Quick and easy assembly

	352 10 11 250	Aluminium Clips skirting board "Cultus45" incl. 6 clips	60 x 14 mm	250 cm S	silver	38,40
	352 10 19 250	Aluminium Clips skirting board "Cultus45" incl. 6 clips	60 x 14 mm	250 cm S	stainless steel brushed	59,25

Schets	Artikelnummer	Omschrijving	Afmeting	Lengte	Kleur	Bruto verkoopprijs / st.
--------	---------------	--------------	----------	--------	-------	--------------------------

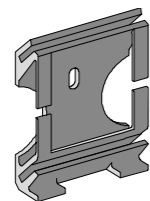
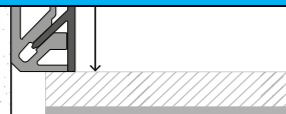

352 00 00 050	Clips for aluminium skirting board no. 352	50 pcs / box		50 pcs / box		1,25
---------------	--	--------------	--	--------------	--	-------------

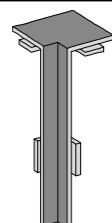

352 01 11 000	Aluminium Inner corner - for skirting board no. 352.	1 pc. / bag		silver		24,30
352 01 19 000	Aluminium Inner corner - for skirting board no. 352.	1 pc. / bag		stainless steel brushed		24,30

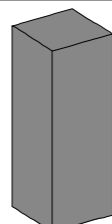

352 02 11 000	Aluminium Outer corner - for skirting board no. 352.	1 pc. / bag		silver		24,30
352 02 19 000	Aluminium Outer corner - for skirting board no. 352.	1 pc. / bag		stainless steel brushed		24,30

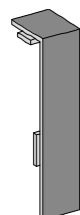

352 03 11 000	Aluminium Profile tie - for skirting board no. 352.	1 pc. / bag		silver		14,85
352 03 19 000	Aluminium Profile tie - for skirting board no. 352.	1 pc. / bag		stainless steel brushed		14,85



352 04 11 000	Aluminium End cap left-hand - for skirting board no. 352.	1 pc. / bag		silver		14,85
352 04 19 000	Aluminium End cap left-hand - for skirting board no. 352.	1 pc. / bag		stainless steel brushed		14,85

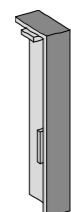

352 05 11 000	Aluminium End cap right-hand - for skirting board no. 352.	1 pc. / bag		silver		14,85
352 05 19 000	Aluminium End cap right-hand - for skirting board no. 352.	1 pc. / bag		stainless steel brushed		14,85

Aluminium Clip Skirting Boards

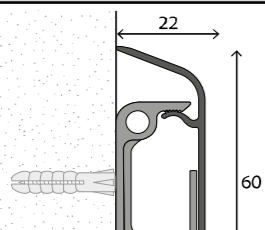

- > Aluminium skirting board clippable with concealed cable duct.
- > Floor covering width 22 mm.
- > Easy disassembly of upper profile in case of need.
- > Shrink-wrapped incl. skirting clips and fixing material.
- > Perfectly combinable with Prinz PS 400 cable ducts.

350 10 11 250	Aluminium Clip skirting board with concealed cable duct, incl. 6 clips.	22 x 60 mm	250 cm S	silver		33,00
---------------	---	------------	----------	--------	--	--------------

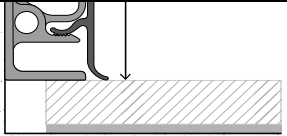
Schets	Artikelnummer	Omschrijving	Afmeting	Lengte	Kleur	Bruto verkoopprijs / st.
	350 10 14 250	Aluminium Clip skirting board with concealed cable duct, incl. 6 clips.	22 x 60 mm	250 cm S	stainless steel matt	37,75

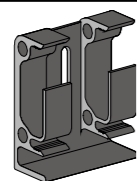

350 00 00 000	Clips for aluminium skirting board no. 350				10 pcs / box	1,25
---------------	--	--	--	--	--------------	-------------

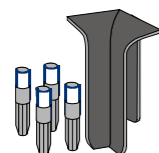

814 40 11 002	PVC Inner corners for clip skirting board no. 350	1 pc. / bag			silver	4,50
814 40 14 002	PVC Inner corners for clip skirting board no. 350	1 pc. / bag			stainless steel matt	4,50

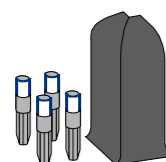

814 50 11 002	PVC Outer corners for clip skirting board no. 350	1 pc. / bag			silver	4,50
814 50 14 002	PVC Outer corners for clip skirting board no. 350	1 pc. / bag			stainless steel matt	4,50

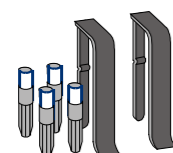

814 70 11 002	PVC Profile ties for clip skirting board no. 350	2 pcs / bag			silver	4,50
814 70 14 002	PVC Profile ties for clip skirting board no. 350	2 pcs / bag			stainless steel matt	4,50

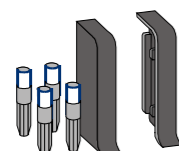

814 60 11 002	PVC End caps for clip skirting board no. 350	1 x left, 1 x right			silver	4,50
814 60 14 002	PVC End caps for clip skirting board no. 350	1 x left, 1 x right			stainless steel matt	4,50

Aluminium Wall Skirting Boards

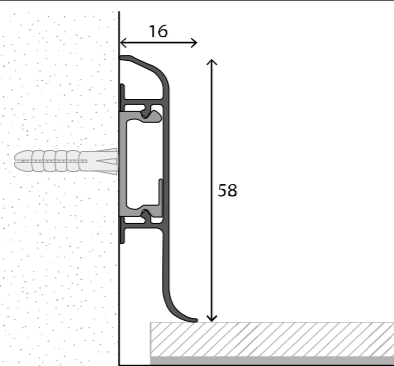

- > Aluminium Wall skirting board - ideal for fastening with clips or fastening with assembly adhesives.
- > Floor covering width 16 mm.
- > Concealed cable duct possible.
- > Clips are not included - please see art. no. 814 55 00 000.

362 10 11 250	Aluminium Skirting board 58 mm, without screw holes	16 x 58 mm	250 cm S		silver	29,40
362 10 14 250	Aluminium Skirting board 58 mm, without screw holes	16 x 58 mm	250 cm S		stainless steel matt	34,15

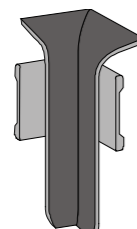

814 43 11 002	PVC Inner corner for aluminium, 58 mm	1 pc. / bag			silver	4,50
814 43 14 002	PVC Inner corner for aluminium, 58 mm	1 pc. / bag			stainless steel matt	4,50

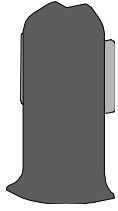
Schets	Artikelnummer	Omschrijving	Afmeting	Lengte	Kleur	Bruto verkoopprijs / st.
	814 53 11 002	PVC Outer corner for aluminium, 58 mm	1 pc. / bag		silver	4,50
	814 53 14 002	PVC Outer corner for aluminium, 58 mm	1 pc. / bag		stainless steel matt	4,50

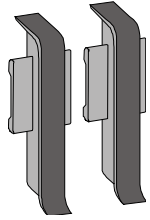
	814 73 11 002	PVC Profile ties for aluminium skirting board, 58 mm	2 pcs / bag		silver	4,50
	814 73 14 002	PVC Profile ties for aluminium skirting board, 58 mm	2 pcs / bag		stainless steel matt	4,50

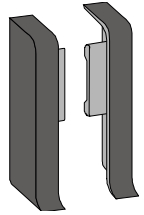
	814 63 11 002	PVC end caps for aluminium skirting board, 58 mm	1 left+1 right/bag		silver	4,50
	814 63 14 002	PVC end caps for aluminium skirting board, 58 mm	1 left+1 right/bag		stainless steel matt	4,50

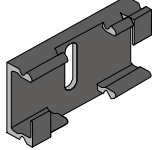
	814 55 00 000	Plastic Clips for aluminium skirting board no. 362	6 pcs / bag			4,30
---	---------------	--	-------------	--	--	-------------

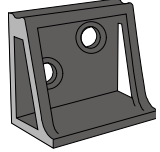
	814 55 01 000	Drilling jig for aluminium skirting board no. 362	1 pc. / bag			1,95
---	---------------	---	-------------	--	--	-------------

Aluminium Wall Skirting Board for Design Floorings

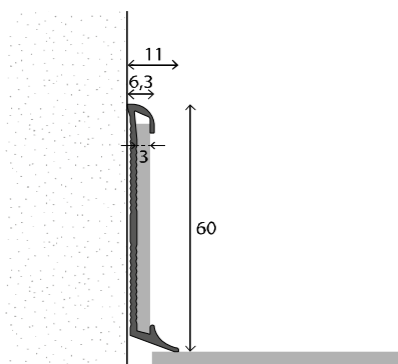

- > Aluminium wall skirting board for design floorings.
- > For floor coverings 2,0 - 3,0 mm or 4,0 - 5,0 mm.
- > Cover strip can be inserted and replaced subsequently without problems.
- > Floor covering width 11 mm or 13 mm.

378 10 11 400	Aluminium wall skirting board - without screw holes - for floor coverings 2 - 3 mm.	11 x 60 mm	400 cm	silver	38,40
378 20 11 270	Aluminium wall skirting board - without screw holes - for floor coverings 2 - 3 mm.	11 x 60 mm	270 cm S	silver	26,10
378 10 08 400	Aluminium wall skirting board - without screw holes - for floor coverings 2 - 3 mm.	11 x 60 mm	400 cm	titan	44,20
378 20 08 270	Aluminium wall skirting board - without screw holes - for floor coverings 2 - 3 mm.	11 x 60 mm	270 cm S	titan	30,55

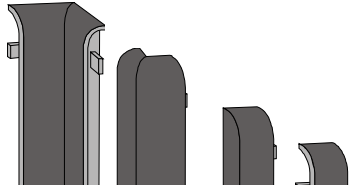
	378 01 11 000	Aluminium Inner corner for wall skirting board no. 378.	11 x 60 mm	1 pc. / bag	silver	24,30
	378 01 08 000	Aluminium Inner corner for wall skirting board no. 378.	11 x 60 mm	1 pc. / bag	titan	24,30

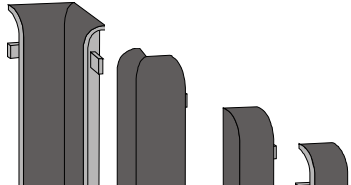
	378 02 11 000	Aluminium Outer corner for wall skirting board no. 378.	11 x 60 mm	1 pc. / bag	silver	24,30
	378 02 08 000	Aluminium Outer corner for wall skirting board no. 378.	11 x 60 mm	1 pc. / bag	titan	24,30

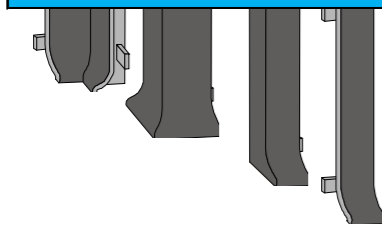
Schets	Artikelnummer	Omschrijving	Afmeting	Lengte	Kleur	Bruto verkoopprijs / st.
	378 04 11 000	Aluminium End cap left for wall skirting board no. 378.	11 x 60 mm	1 pc. / bag	silver	14,85
	378 04 08 000	Aluminium End cap left for wall skirting board no. 378.	11 x 60 mm	1 pc. / bag	titan	14,85
	378 05 11 000	Aluminium End cap right for wall skirting board no. 378.	11 x 60 mm	1 pc. / bag	silver	14,85
	378 05 08 000	Aluminium End cap right for wall skirting board no. 378.	11 x 60 mm	1 pc. / bag	titan	14,85

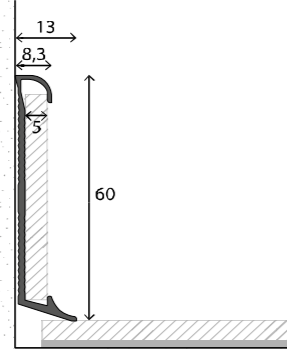
	379 10 11 400	Aluminium wall skirting board - without screw holes - for floor coverings 4 - 5 mm.	13 x 60 mm	400 cm	silver	39,40
	379 20 11 270	Aluminium wall skirting board - without screw holes - for floor coverings 4 - 5 mm.	13 x 60 mm	270 cm S	silver	26,90
	379 10 08 400	Aluminium wall skirting board - without screw holes - for floor coverings 4 - 5 mm.	13 x 60 mm	400 cm	titan	45,40
	379 20 08 270	Aluminium wall skirting board - without screw holes - for floor coverings 4 - 5 mm.	13 x 60 mm	270 cm S	titan	31,50

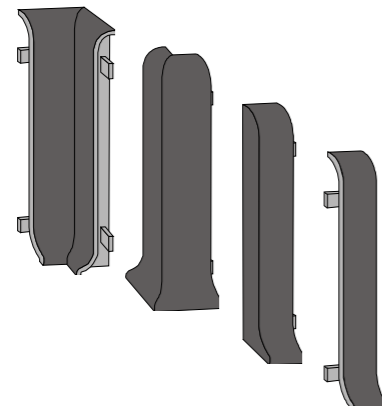
	379 01 11 000	Aluminium Inner corner for wall skirting board no. 379.	13 x 60 mm	1 pc. / bag	silver	24,30
	379 01 08 000	Aluminium Inner corner for wall skirting board no. 379.	13 x 60 mm	1 pc. / bag	titan	24,30
	379 02 11 000	Aluminium Outer corner for wall skirting board no. 379.	13 x 60 mm	1 pc. / bag	silver	24,30
	379 02 08 000	Aluminium Outer corner for wall skirting board no. 379.	13 x 60 mm	1 pc. / bag	titan	24,30
	379 04 11 000	Aluminium End cap left for wall skirting board no. 379.	13 x 60 mm	1 pc. / bag	silver	14,85
	379 04 08 000	Aluminium End cap left for wall skirting board no. 379.	13 x 60 mm	1 pc. / bag	titan	14,85
	379 05 11 000	Aluminium End cap right for wall skirting board no. 379.	13 x 60 mm	1 pc. / bag	silver	14,85
	379 05 08 000	Aluminium End cap right for wall skirting board no. 379.	13 x 60 mm	1 pc. / bag	titan	14,85

Aluminium-Skirting Boards

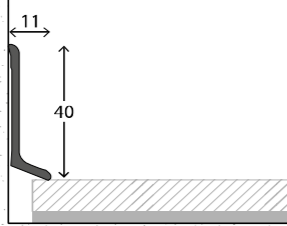
	371 10 11 400	Aluminium Wall skirting board - without screw holes.	11 x 40 mm	400 cm	silver	30,00
	371 20 11 270	Aluminium Wall skirting board - without screw holes.	11 x 40 mm	270 cm S	silver	19,75
	371 10 08 400	Aluminium Wall skirting board - without screw holes.	11 x 40 mm	400 cm	titan	32,40
	371 20 08 270	Aluminium Wall skirting board - without screw holes.	11 x 40 mm	270 cm S	titan	21,50

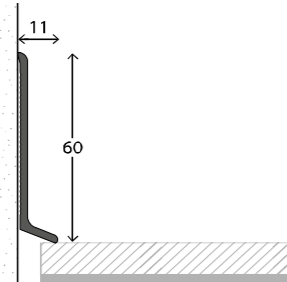
	372 10 11 400	Aluminium Wall skirting board - without screw holes.	11 x 60 mm	400 cm	silver	40,60
	372 20 11 270	Aluminium Wall skirting board - without screw holes.	11 x 60 mm	270 cm S	silver	26,90
	372 10 08 400	Aluminium Wall skirting board - without screw holes.	11 x 60 mm	400 cm	titan	44,00
	372 20 08 270	Aluminium Wall skirting board - without screw holes.	11 x 60 mm	270 cm S	titan	29,30
	372 10 32 400	Aluminium Wall skirting board - without screw holes.	11 x 60 mm	400 cm	black (RAL 9005)	49,80
	372 20 32 270	Aluminium Wall skirting board - without screw holes.	11 x 60 mm	270 cm S	black (RAL 9005)	33,35

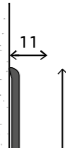
	373 10 11 400	Aluminium Wall skirting board - without screw holes.	11 x 80 mm	400 cm	silver	52,60
	373 20 11 270	Aluminium Wall skirting board - without screw holes.	11 x 80 mm	270 cm S	silver	34,20
	373 10 08 400	Aluminium Wall skirting board - without screw holes.	11 x 80 mm	400 cm	titan	57,20
	373 20 08 270	Aluminium Wall skirting board - without screw holes.	11 x 80 mm	270 cm S	titan	37,30

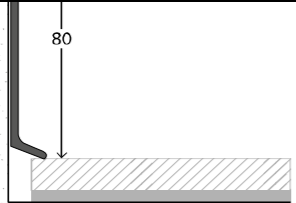
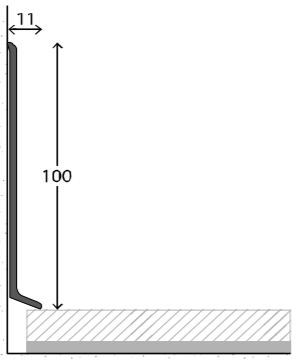
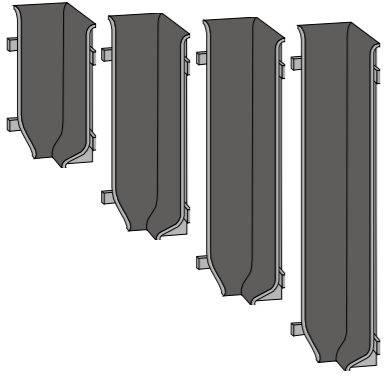
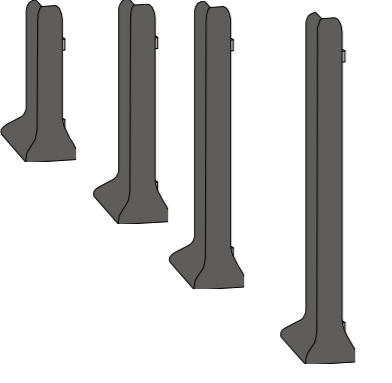
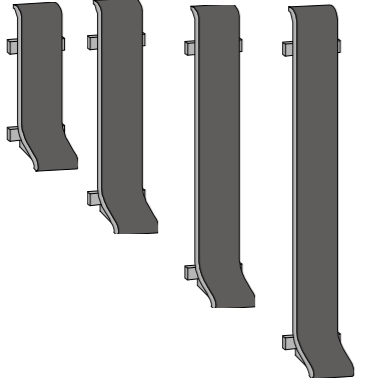
Schets	Artikelnummer	Omschrijving	Afmeting	Lengte	Kleur	Bruto verkoopprijs / st.
						
	374 10 11 400	Aluminium Wall skirting board - without screw holes.	11 x 100 mm	400 cm	silber	63,00
	374 20 11 270	Aluminium Wall skirting board - without screw holes.	11 x 100 mm	270 cm S	silber	41,60
	374 10 08 400	Aluminium Wall skirting board - without screw holes.	11 x 100 mm	400 cm	titan	68,60
	374 20 08 270	Aluminium Wall skirting board - without screw holes.	11 x 100 mm	270 cm S	titan	45,10
	371 01 11 000	Aluminium Inner corner for wall skirting board no. 371	11 x 40 mm	1 pc. / bag	silver	21,45
	371 01 08 000	Aluminium Inner corner for wall skirting board no. 371	11 x 40 mm	1 pc. / bag	titan	21,45
	372 01 11 000	Aluminium Inner corner for wall skirting board no. 372	11 x 60 mm	1 pc. / bag	silver	23,15
	372 01 08 000	Aluminium Inner corner for wall skirting board no. 372	11 x 60 mm	1 pc. / bag	titan	23,15
	372 01 32 000	Aluminium Inner corner for wall skirting board no. 372	11 x 60 mm	1 pc. / bag	black (RAL 9005)	0,00
	373 01 11 000	Aluminium Inner corner for wall skirting board no. 373	11 x 80 mm	1 pc. / bag	silver	25,00
	373 01 08 000	Aluminium Inner corner for wall skirting board no. 373	11 x 80 mm	1 pc. / bag	titan	25,00
	374 01 11 000	Aluminium Inner corner for wall skirting board no. 374	11 x 100 mm	1 pc. / bag	silver	27,20
374 01 08 000	Aluminium Inner corner for wall skirting board no. 374	11 x 100 mm	1 pc. / bag	titan	27,20	
	371 02 11 000	Aluminium Outer corner for wall skirting board no. 371	11 x 40 mm	1 pc. / bag	silver	21,45
	371 02 08 000	Aluminium Outer corner for wall skirting board no. 371	11 x 40 mm	1 pc. / bag	titan	21,45
	372 02 11 000	Aluminium Outer corner for wall skirting board no. 372	11 x 60 mm	1 pc. / bag	silver	23,15
	372 02 08 000	Aluminium Outer corner for wall skirting board no. 372	11 x 60 mm	1 pc. / bag	titan	23,15
	372 02 32 000	Aluminium Outer corner for wall skirting board no. 372	11 x 60 mm	1 pc. / bag	black (RAL 9005)	0,00
	373 02 11 000	Aluminium Outer corner for wall skirting board no. 373	11 x 80 mm	1 pc. / bag	silver	25,00
	373 02 08 000	Aluminium Outer corner for wall skirting board no. 373	11 x 80 mm	1 pc. / bag	titan	25,00
	374 02 11 000	Aluminium Outer corner for wall skirting board no. 374	11 x 100 mm	1 pc. / bag	silver	27,20
374 02 08 000	Aluminium Outer corner for wall skirting board no. 374	11 x 100 mm	1 pc. / bag	titan	27,20	
	371 03 11 000	Aluminium Profile tie for wall skirting board no. 371	11 x 40 mm	1 pc. / bag	silver	12,65
	371 03 08 000	Aluminium Profile tie for wall skirting board no. 371	11 x 40 mm	1 pc. / bag	titan	12,65
	372 03 11 000	Aluminium Profile tie for wall skirting board no. 372	11 x 60 mm	1 pc. / bag	silver	14,00
	372 03 08 000	Aluminium Profile tie for wall skirting board no. 372	11 x 60 mm	1 pc. / bag	titan	14,00
	372 03 32 000	Aluminium Profile tie for wall skirting board no. 372	11 x 60 mm	1 pc. / bag	black (RAL 9005)	0,00
	373 03 11 000	Aluminium Profile tie for wall skirting board no. 373	11 x 80 mm	1 pc. / bag	silver	15,95
	373 03 08 000	Aluminium Profile tie for wall skirting board no. 373	11 x 80 mm	1 pc. / bag	titan	15,95
	374 03 11 000	Aluminium Profile tie for wall skirting board no. 374	11 x 100 mm	1 pc. / bag	silver	18,15
	374 03 08 000	Aluminium Profile tie for wall skirting board no. 374	11 x 100 mm	1 pc. / bag	titan	18,15

Schets	Artikelnummer	Omschrijving	Afmeting	Lengte	Kleur	Bruto verkoopprijs / st.
	371 04 11 000	Aluminium End cap left for wall skirting board no. 371	11 x 40 mm	1 pc. / bag	silver	12,65
	371 04 08 000	Aluminium End cap left for wall skirting board no. 371	11 x 40 mm	1 pc. / bag	titan	12,65
	372 04 11 000	Aluminium End cap left for wall skirting board no. 372	11 x 60 mm	1 pc. / bag	silver	14,00
	372 04 08 000	Aluminium End cap left for wall skirting board no. 372	11 x 60 mm	1 pc. / bag	titan	22,55
	372 04 32 000	Aluminium End cap left for wall skirting board no. 372	11 x 60 mm	1 pc. / bag	black (RAL 9005)	0,00
	373 04 11 000	Aluminium End cap left for wall skirting board no. 373	11 x 80 mm	1 pc. / bag	silver	15,95
	373 04 08 000	Aluminium End cap left for wall skirting board no. 373	11 x 80 mm	1 pc. / bag	titan	15,95
	374 04 11 000	Aluminium End cap left for wall skirting board no. 374	11 x 100 mm	1 pc. / bag	silver	18,15
374 04 08 000	Aluminium End cap left for wall skirting board no. 374	11 x 100 mm	1 pc. / bag	titan	18,15	
	371 05 11 000	Aluminium End cap right for wall skirting board no. 371	11 x 40 mm	1 pc. / bag	silver	12,65
	371 05 08 000	Aluminium End cap right for wall skirting board no. 371	11 x 40 mm	1 pc. / bag	titan	12,65
	372 05 11 000	Aluminium End cap right for wall skirting board no. 372	11 x 60 mm	1 pc. / bag	silver	14,00
	372 05 08 000	Aluminium End cap right for wall skirting board no. 372	11 x 60 mm	1 pc. / bag	titan	14,00
	372 05 32 000	Aluminium End cap right for wall skirting board no. 372	11 x 60 mm	1 pc. / bag	black (RAL 9005)	0,00
	373 05 11 000	Aluminium End cap right for wall skirting board no. 373	11 x 80 mm	1 pc. / bag	silver	15,95
	373 05 08 000	Aluminium End cap right for wall skirting board no. 373	11 x 80 mm	1 pc. / bag	titan	15,95
	374 05 11 000	Aluminium End cap right for wall skirting board no. 374	11 x 100 mm	1 pc. / bag	silver	18,15
374 05 08 000	Aluminium End cap right for wall skirting board no. 374	11 x 100 mm	1 pc. / bag	titan	18,15	

Stainless Steel Skirting Boards

	384 10 02 250	Stainless steel skirting board	15 x 60 mm	250 cm S	brushed	38,00
--	---------------	--------------------------------	------------	----------	---------	--------------

	385 10 02 250	Stainless steel skirting board	15 x 80 mm	250 cm S	brushed	48,00
--	---------------	--------------------------------	------------	----------	---------	--------------

Two Parts Aluminium Skirting Board

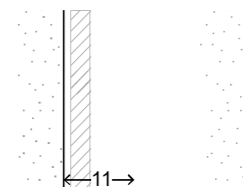

- > Aluminium skirting profile for design coverings.
- > Can be used to design a skirting board with freely selectable skirting height.
- > Can also be used as a stair nosing profile or cove and cap profile for wall connection.

Skirting sections no. 380 are combinable with edge sections nos. 709, 700, 156, 157, 169.

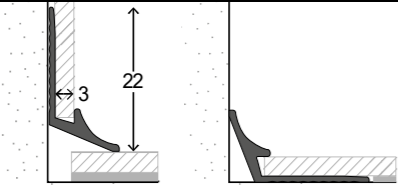
Schets	Artikelnummer	Omschrijving	Afmeting	Lengte	Kleur	Bruto verkoopprijs / st.
	380 10 11 250	Aluminium Border section - without screw holes - for floor coverings 2,5 – 3 mm.	11 x 22 mm	250 cm	silver	12,25
	380 10 14 250	Aluminium Border section - without screw holes - for floor coverings 2,5 – 3 mm.	11 x 22 mm	250 cm	stainless steel matt	14,40

LED-Duct "LUXline"

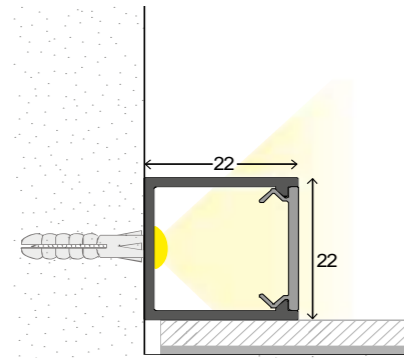

- > LUXline is suitable for placing with LED-lighting strips as well as other cables.
- > It can be separately placed on the floor, at the wall or on the ceiling.
- > In addition, it can be optimally combined with skirtings that have a base cover width of 20 - 22 mm.
- > LUXline has a flap on the front side that allows cables to be replaced - even after installation.
- > The LED channel can be glued to the wall or screwed to the wall using the slotted holes provided.

873 00 00 250	LED-DUCT "LUXline", PET translucent, with slotted holes.	22 x 22 mm	250 cm	opal	17,15
---------------	--	------------	--------	------	--------------

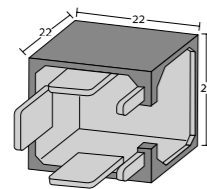

- > The corner piece can be used both as an end piece and as an Inner or outer corner.
- > Subsequent replacement of cables is possible without any problems.

873 01 00 000	Corner piece for LED-DUCT, 1 piece per bag	22 x 22 mm	SB	opal	4,55
---------------	--	------------	----	------	-------------

Laminated Wall Skirtings

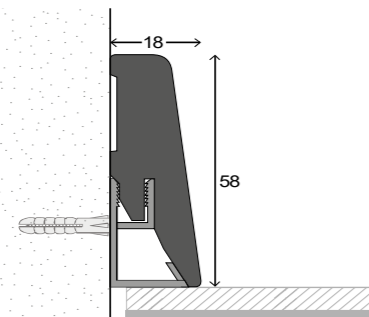

809 00 98 250	Laminated wall skirting board - MDF core covered with decorative wood foil	18 x 58 mm	250 cm	white foil	10,25
809 00 31 250	Laminated wall skirting board - MDF core covered with decorative wood foil	18 x 58 mm	250 cm	grey	10,25
809 00 32 250	Laminated wall skirting board - MDF core covered with decorative wood foil	18 x 58 mm	250 cm	black	10,25

809 00 21 250	Laminated wall skirting board - MDF core covered with decorative wood foil	18 x 58 mm	250 cm	oak medium	10,25
809 00 35 250	Laminated wall skirting board - MDF core covered with decorative wood foil	18 x 58 mm	250 cm	oak Marineo	10,25
809 00 36 250	Laminated wall skirting board - MDF core covered with decorative wood foil	18 x 58 mm	250 cm	pine Madera Blanda	10,25
809 00 37 250	Laminated wall skirting board - MDF core covered with decorative wood foil	18 x 58 mm	250 cm	Multistrip Country	10,25
809 00 51 250	Laminated wall skirting board - MDF core covered with decorative wood foil	18 x 58 mm	250 cm	alpine larch grey	10,25
809 00 60 250	Laminated wall skirting board - MDF core covered with decorative wood foil	18 x 58 mm	250 cm	Arenberg	10,25
809 00 74 250	Laminated wall skirting board - MDF core covered with decorative wood foil	18 x 58 mm	250 cm	oil slate	10,25
809 00 76 250	Laminated wall skirting board - MDF core covered with decorative wood foil	18 x 58 mm	250 cm	white oak	10,25
809 00 77 250	Laminated wall skirting board - MDF core covered with decorative wood foil	18 x 58 mm	250 cm	snow pine	10,25
809 00 78 250	Laminated wall skirting board - MDF core covered with decorative wood foil	18 x 58 mm	250 cm	elegance oak	10,25
809 00 79 250	Laminated wall skirting board - MDF core covered with decorative wood foil	18 x 58 mm	250 cm	Colorado oak	10,25
809 00 80 250	Laminated wall skirting board - MDF core covered with decorative wood foil	18 x 58 mm	250 cm	Victoria oak	10,25
809 00 81 250	Laminated wall skirting board - MDF core covered with decorative wood foil	18 x 58 mm	250 cm	Rushmore	10,25
809 00 82 250	Laminated wall skirting board - MDF core covered with decorative wood foil	18 x 58 mm	250 cm	Columbia oak	10,25
809 00 83 250	Laminated wall skirting board - MDF core covered with decorative wood foil	18 x 58 mm	250 cm	Seattle oak	10,25
809 00 84 250	Laminated wall skirting board - MDF core covered with decorative wood foil	18 x 58 mm	250 cm	maple	10,25
809 00 86 250	Laminated wall skirting board - MDF core covered with decorative wood foil	18 x 58 mm	250 cm	Aristan Oak	10,25
809 00 87 250	Laminated wall skirting board - MDF core covered with decorative wood foil	18 x 58 mm	250 cm	Evanos Oak	10,25
809 00 88 250	Laminated wall skirting board - MDF core covered with decorative wood foil	18 x 58 mm	250 cm	Royal Oak	10,25
809 00 89 250	Laminated wall skirting board - MDF core covered with decorative wood foil	18 x 58 mm	250 cm	royal beech	10,25

Schets	Artikelnummer	Omschrijving	Afmeting	Lengte	Kleur	Bruto verkoopprijs / st.
	809 00 90 250	Laminated wall skirting board - MDF core covered with decorative wood foil	18 x 58 mm	250 cm	copper beech	10,25
	809 00 91 250	Laminated wall skirting board - MDF core covered with decorative wood foil	18 x 58 mm	250 cm	beech	10,25
	809 00 92 250	Laminated wall skirting board - MDF core covered with decorative wood foil	18 x 58 mm	250 cm	Aspen oak	10,25
	809 00 93 250	Laminated wall skirting board - MDF core covered with decorative wood foil	18 x 58 mm	250 cm	walnut	10,25
	809 00 94 250	Laminated wall skirting board - MDF core covered with decorative wood foil	18 x 58 mm	250 cm	canyon pine	10,25
	809 00 96 250	Laminated wall skirting board - MDF core covered with decorative wood foil	18 x 58 mm	250 cm	attic oak	10,25
	809 00 97 250	Laminated wall skirting board - MDF core covered with decorative wood foil	18 x 58 mm	250 cm	chateau oak	10,25
	809 00 99 250	Laminated wall skirting board - MDF core covered with decorative wood foil	18 x 58 mm	250 cm	Wenge	10,25
	809 00 01 250	Laminated wall skirting board - MDF core covered with special decorative wood foil	18 x 58 mm	250 cm	pebble	16,15
	809 00 02 250	Laminated wall skirting board - MDF core covered with special decorative wood foil	18 x 58 mm	250 cm	stone	16,15
	809 00 03 250	Laminated wall skirting board - MDF core covered with special decorative wood foil	18 x 58 mm	250 cm	stainless steel brushed	16,15
	809 00 04 250	Laminated wall skirting board - MDF core covered with special decorative wood foil	18 x 58 mm	250 cm	Alu brushed	16,15
	814 59 00 030	Clips for wall skirting boards, incl. screws and plugs.	30 pcs. / carton			9,40

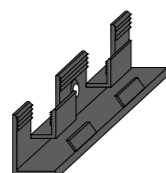

	814 18 98 002	Inner corners - PVC - for wall skirting board no.809.	18 x 58 mm	2 pcs. / bag	white	5,55
	814 18 06 002	Inner corners - PVC - for wall skirting board no.809.	18 x 58 mm	2 pcs. / bag	creme-beige	5,55
	814 18 31 002	Inner corners - PVC - for wall skirting board no.809.	18 x 58 mm	2 pcs. / bag	grey	5,55
	814 18 32 002	Inner corners - PVC - for wall skirting board no.809.	18 x 58 mm	2 pcs. / bag	black	5,55
	814 18 74 002	Inner corners - PVC - for wall skirting board no.809.	18 x 58 mm	2 pcs. / bag	oil slate	5,55
	814 18 76 002	Inner corners - PVC - for wall skirting board no.809.	18 x 58 mm	2 pcs. / bag	White Oak	5,55
	814 18 77 002	Inner corners - PVC - for wall skirting board no.809.	18 x 58 mm	2 pcs. / bag	Snow pine	5,55
	814 18 78 002	Inner corners - PVC - for wall skirting board no.809.	18 x 58 mm	2 pcs. / bag	Elegance Oak	5,55
	814 18 79 002	Inner corners - PVC - for wall skirting board no.809.	18 x 58 mm	2 pcs. / bag	Colorado Oak	5,55
	814 18 80 002	Inner corners - PVC - for wall skirting board no.809.	18 x 58 mm	2 pcs. / bag	Victoria Oak	5,55
	814 18 81 002	Inner corners - PVC - for wall skirting board no.809.	18 x 58 mm	2 pcs. / bag	Rushmore	5,55
	814 18 82 002	Inner corners - PVC - for wall skirting board no.809.	18 x 58 mm	2 pcs. / bag	Columbia Oak	5,55
	814 18 83 002	Inner corners - PVC - for wall skirting board no.809.	18 x 58 mm	2 pcs. / bag	Seattle Oak	5,55
	814 18 84 002	Inner corners - PVC - for wall skirting board no.809.	18 x 58 mm	2 pcs. / bag	maple	5,55
	814 18 86 002	Inner corners - PVC - for wall skirting board no.809.	18 x 58 mm	2 pcs. / bag	Aristan Oak	5,55
	814 18 87 002	Inner corners - PVC - for wall skirting board no.809.	18 x 58 mm	2 pcs. / bag	Evanos Oak	5,55
	814 18 88 002	Inner corners - PVC - for wall skirting board no.809.	18 x 58 mm	2 pcs. / bag	Royal Oak	5,55
	814 18 89 002	Inner corners - PVC - for wall skirting board no.809.	18 x 58 mm	2 pcs. / bag	Royal beech	5,55
	814 18 90 002	Inner corners - PVC - for wall skirting board no.809.	18 x 58 mm	2 pcs. / bag	red beech	5,55
	814 18 91 002	Inner corners - PVC - for wall skirting board no.809.	18 x 58 mm	2 pcs. / bag	beech	5,55
	814 18 92 002	Inner corners - PVC - for wall skirting board no.809.	18 x 58 mm	2 pcs. / bag	Aspen Oak	5,55
	814 18 93 002	Inner corners - PVC - for wall skirting board no.809.	18 x 58 mm	2 pcs. / bag	walnut	5,55
	814 18 94 002	Inner corners - PVC - for wall skirting board no.809.	18 x 58 mm	2 pcs. / bag	Canyon Pinie	5,55
	814 18 95 002	Inner corners - PVC - for wall skirting board no.809.	18 x 58 mm	2 pcs. / bag	Tabak Oak	5,55
	814 18 96 002	Inner corners - PVC - for wall skirting board no.809.	18 x 58 mm	2 pcs. / bag	Attic Oak	5,55
	814 18 97 002	Inner corners - PVC - for wall skirting board no.809.	18 x 58 mm	2 pcs. / bag	Chateau Oak	5,55
	814 18 99 002	Inner corners - PVC - for wall skirting board no.809.	18 x 58 mm	2 pcs. / bag	Wenge	5,55
	814 18 01 002	Inner corners - PVC - special design - for wall skirting board no.809.	18 x 58 mm	2 pcs. / bag	pebble	5,55
	814 18 02 002	Inner corners - PVC - special design - for wall skirting board no.809.	18 x 58 mm	2 pcs. / bag	stone	5,55

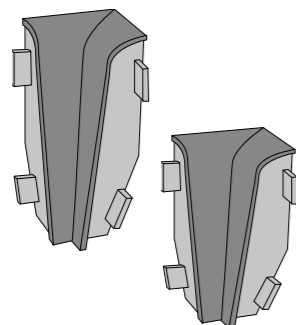

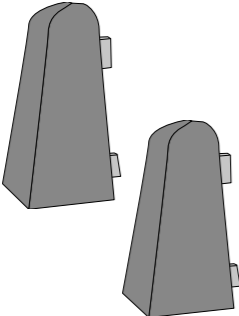
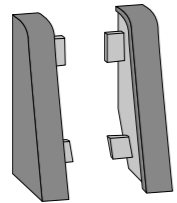
Schets	Artikelnummer	Omschrijving	Afmeting	Lengte	Kleur	Bruto verkoopprijs / st.
	814 18 03 002	Inner corners - PVC - special design - for wall skirting board no.809.	18 x 58 mm	2 pcs. / bag	stainless steel brushed	5,55
	814 18 04 002	Inner corners - PVC - special design - for wall skirting board no.809.	18 x 58 mm	2 pcs. / bag	Alu brushed	5,55
	814 28 98 002	Outer corners - PVC - for wall skirting board no.809.	18 x 58 mm	2 pcs. / bag	white	5,55
	814 28 06 002	Outer corners - PVC - for wall skirting board no.809.	18 x 58 mm	2 pcs. / bag	creme-beige	5,55
	814 28 31 002	Outer corners - PVC - for wall skirting board no.809.	18 x 58 mm	2 pcs. / bag	grey	5,55
	814 28 32 002	Outer corners - PVC - for wall skirting board no.809.	18 x 58 mm	2 pcs. / bag	black	5,55
	814 28 74 002	Outer corners - PVC - for wall skirting board no.809.	18 x 58 mm	2 pcs. / bag	oil slate	5,55
	814 28 76 002	Outer corners - PVC - for wall skirting board no.809.	18 x 58 mm	2 pcs. / bag	White Oak	5,55
	814 28 77 002	Outer corners - PVC - for wall skirting board no.809.	18 x 58 mm	2 pcs. / bag	Snow pine	5,55
	814 28 78 002	Outer corners - PVC - for wall skirting board no.809.	18 x 58 mm	2 pcs. / bag	Elegance Oak	5,55
	814 28 79 002	Outer corners - PVC - for wall skirting board no.809.	18 x 58 mm	2 pcs. / bag	Colorado Oak	5,55
	814 28 80 002	Outer corners - PVC - for wall skirting board no.809.	18 x 58 mm	2 pcs. / bag	Victoria Oak	5,55
	814 28 81 002	Outer corners - PVC - for wall skirting board no.809.	18 x 58 mm	2 pcs. / bag	Rushmore	5,55
	814 28 82 002	Outer corners - PVC - for wall skirting board no.809.	18 x 58 mm	2 pcs. / bag	Columbia Oak	5,55
	814 28 83 002	Outer corners - PVC - for wall skirting board no.809.	18 x 58 mm	2 pcs. / bag	Seattle Oak	5,55
	814 28 84 002	Outer corners - PVC - for wall skirting board no.809.	18 x 58 mm	2 pcs. / bag	maple	5,55
	814 28 86 002	Outer corners - PVC - for wall skirting board no.809.	18 x 58 mm	2 pcs. / bag	Aristan Oak	5,55
	814 28 87 002	Outer corners - PVC - for wall skirting board no.809.	18 x 58 mm	2 pcs. / bag	Evanos Oak	5,55
	814 28 88 002	Outer corners - PVC - for wall skirting board no.809.	18 x 58 mm	2 pcs. / bag	Royal Oak	5,55
	814 28 89 002	Outer corners - PVC - for wall skirting board no.809.	18 x 58 mm	2 pcs. / bag	Royal beech	5,55
	814 28 90 002	Outer corners - PVC - for wall skirting board no.809.	18 x 58 mm	2 pcs. / bag	red beech	5,55
	814 28 91 002	Outer corners - PVC - for wall skirting board no.809.	18 x 58 mm	2 pcs. / bag	beech	5,55
	814 28 92 002	Outer corners - PVC - for wall skirting board no.809.	18 x 58 mm	2 pcs. / bag	Aspen Oak	5,55
	814 28 93 002	Outer corners - PVC - for wall skirting board no.809.	18 x 58 mm	2 pcs. / bag	walnut	5,55
	814 28 94 002	Outer corners - PVC - for wall skirting board no.809.	18 x 58 mm	2 pcs. / bag	Canyon Pinie	5,55
	814 28 95 002	Outer corners - PVC - for wall skirting board no.809.	18 x 58 mm	2 pcs. / bag	Tabak Oak	5,55
	814 28 96 002	Outer corners - PVC - for wall skirting board no.809.	18 x 58 mm	2 pcs. / bag	Attic Oak	5,55
	814 28 97 002	Outer corners - PVC - for wall skirting board no.809.	18 x 58 mm	2 pcs. / bag	Chateau Oak	5,55
	814 28 99 002	Outer corners - PVC - for wall skirting board no.809.	18 x 58 mm	2 pcs. / bag	Wenge	5,55
	814 28 01 002	Outer corners - PVC - special design - for wall skirting board no.809.	18 x 58 mm	2 pcs. / bag	pebble	5,55
	814 28 02 002	Outer corners - PVC - special design - for wall skirting board no.809.	18 x 58 mm	2 pcs. / bag	stone	5,55
	814 28 03 002	Outer corners - PVC - special design - for wall skirting board no.809.	18 x 58 mm	2 pcs. / bag	stainless steel brushed	5,55
	814 28 04 002	Outer corners - PVC - special design - for wall skirting board no.809.	18 x 58 mm	2 pcs. / bag	Alu brushed	5,55
	814 38 98 002	End caps - PVC - for wall skirting board no.809.	18 x 58 mm	1 lf + 1 ri / bag	white	5,55
	814 38 06 002	End caps - PVC - for wall skirting board no.809.	18 x 58 mm	1 lf + 1 ri / bag	creme-beige	5,55
	814 38 31 002	End caps - PVC - for wall skirting board no.809.	18 x 58 mm	1 lf + 1 ri / bag	grey	5,55
	814 38 32 002	End caps - PVC - for wall skirting board no.809.	18 x 58 mm	1 lf + 1 ri / bag	black	5,55
	814 38 74 002	End caps - PVC - for wall skirting board no.809.	18 x 58 mm	1 lf + 1 ri / bag	oil slate	5,55
	814 38 76 002	End caps - PVC - for wall skirting board no.809.	18 x 58 mm	1 lf + 1 ri / bag	White Oak	5,55
	814 38 77 002	End caps - PVC - for wall skirting board no.809.	18 x 58 mm	1 lf + 1 ri / bag	Snow pine	5,55
	814 38 78 002	End caps - PVC - for wall skirting board no.809.	18 x 58 mm	1 lf + 1 ri / bag	Elegance Oak	5,55
	814 38 79 002	End caps - PVC - for wall skirting board no.809.	18 x 58 mm	1 lf + 1 ri / bag	Colorado Oak	5,55
	814 38 80 002	End caps - PVC - for wall skirting board no.809.	18 x 58 mm	1 lf + 1 ri / bag	Victoria Oak	5,55
	814 38 81 002	End caps - PVC - for wall skirting board no.809.	18 x 58 mm	1 lf + 1 ri / bag	Rushmore	5,55
	814 38 82 002	End caps - PVC - for wall skirting board no.809.	18 x 58 mm	1 lf + 1 ri / bag	Columbia Oak	5,55
	814 38 83 002	End caps - PVC - for wall skirting board no.809.	18 x 58 mm	1 lf + 1 ri / bag	Seattle Oak	5,55

Schets	Artikelnummer	Omschrijving	Afmeting	Lengte	Kleur	Bruto verkoopprijs / st.
	814 38 84 002	End caps - PVC - for wall skirting board no.809.	18 x 58 mm	1 lf + 1 ri / bag	maple	5,55
	814 38 86 002	End caps - PVC - for wall skirting board no.809.	18 x 58 mm	1 lf + 1 ri / bag	Aristan Oak	5,55
	814 38 87 002	End caps - PVC - for wall skirting board no.809.	18 x 58 mm	1 lf + 1 ri / bag	Evanos Oak	5,55
	814 38 88 002	End caps - PVC - for wall skirting board no.809.	18 x 58 mm	1 lf + 1 ri / bag	Royal Oak	5,55
	814 38 89 002	End caps - PVC - for wall skirting board no.809.	18 x 58 mm	1 lf + 1 ri / bag	Royal beech	5,55
	814 38 90 002	End caps - PVC - for wall skirting board no.809.	18 x 58 mm	1 lf + 1 ri / bag	red beech	5,55
	814 38 91 002	End caps - PVC - for wall skirting board no.809.	18 x 58 mm	1 lf + 1 ri / bag	beech	5,55
	814 38 92 002	End caps - PVC - for wall skirting board no.809.	18 x 58 mm	1 lf + 1 ri / bag	Aspen Oak	5,55
	814 38 93 002	End caps - PVC - for wall skirting board no.809.	18 x 58 mm	1 lf + 1 ri / bag	walnut	5,55
	814 38 94 002	End caps - PVC - for wall skirting board no.809.	18 x 58 mm	1 lf + 1 ri / bag	Canyon Pinie	5,55
	814 38 95 002	End caps - PVC - for wall skirting board no.809.	18 x 58 mm	1 lf + 1 ri / bag	Tabak Oak	5,55
	814 38 96 002	End caps - PVC - for wall skirting board no.809.	18 x 58 mm	1 lf + 1 ri / bag	Attic Oak	5,55
	814 38 97 002	End caps - PVC - for wall skirting board no.809.	18 x 58 mm	1 lf + 1 ri / bag	Chateau Oak	5,55
	814 38 99 002	End caps - PVC - for wall skirting board no.809.	18 x 58 mm	1 lf + 1 ri / bag	Wenge	5,55

814 38 01 002	End caps - PVC - special design -for wall skirting board no.809.	18 x 58 mm	1 lf + 1 ri / bag	pebble	5,55
814 38 02 002	End caps - PVC - special design -for wall skirting board no.809.	18 x 58 mm	1 lf + 1 ri / bag	stone	5,55
814 38 03 002	End caps - PVC - special design -for wall skirting board no.809.	18 x 58 mm	1 lf + 1 ri / bag	stainless steel brushed	5,55
814 38 04 002	End caps - PVC - special design -for wall skirting board no.809.	18 x 58 mm	1 lf + 1 ri / bag	Alu brushed	5,55

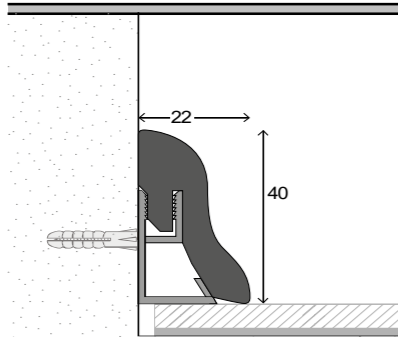

833 00 76 250	Wall skirting board for laminate, covered with decorative wood foil.	22 x 40 mm	250 cm	White Oak	7,50
833 00 77 250	Wall skirting board for laminate, covered with decorative wood foil.	22 x 40 mm	250 cm	Snow pine	7,50
833 00 78 250	Wall skirting board for laminate, covered with decorative wood foil.	22 x 40 mm	250 cm	Elegance Oak	7,50
833 00 79 250	Wall skirting board for laminate, covered with decorative wood foil.	22 x 40 mm	250 cm	Colorado Oak	7,50
833 00 80 250	Wall skirting board for laminate, covered with decorative wood foil.	22 x 40 mm	250 cm	Victoria Oak	7,50
833 00 81 250	Wall skirting board for laminate, covered with decorative wood foil.	22 x 40 mm	250 cm	Rushmore	7,50
833 00 82 250	Wall skirting board for laminate, covered with decorative wood foil.	22 x 40 mm	250 cm	Columbia Oak	7,50
833 00 83 250	Wall skirting board for laminate, covered with decorative wood foil.	22 x 40 mm	250 cm	Seattle Oak	7,50
833 00 84 250	Wall skirting board for laminate, covered with decorative wood foil.	22 x 40 mm	250 cm	maple	7,50
833 00 86 250	Wall skirting board for laminate, covered with decorative wood foil.	22 x 40 mm	250 cm	Aristan Oak	7,50
833 00 87 250	Wall skirting board for laminate, covered with decorative wood foil.	22 x 40 mm	250 cm	Evanos Oak	7,50
833 00 88 250	Wall skirting board for laminate, covered with decorative wood foil.	22 x 40 mm	250 cm	Royal Oak	7,50
833 00 89 250	Wall skirting board for laminate, covered with decorative wood foil.	22 x 40 mm	250 cm	Royal beech	7,50
833 00 91 250	Wall skirting board for laminate, covered with decorative wood foil.	22 x 40 mm	250 cm	beech	7,50
833 00 92 250	Wall skirting board for laminate, covered with decorative wood foil.	22 x 40 mm	250 cm	Aspen Oak	7,50
833 00 93 250	Wall skirting board for laminate, covered with decorative wood foil.	22 x 40 mm	250 cm	walnut	7,50
833 00 94 250	Wall skirting board for laminate, covered with decorative wood foil.	22 x 40 mm	250 cm	Canyon Pinie	7,50
833 00 96 250	Wall skirting board for laminate, covered with decorative wood foil.	22 x 40 mm	250 cm	Attic Oak	7,50
833 00 97 250	Wall skirting board for laminate, covered with decorative wood foil.	22 x 40 mm	250 cm	Chateau Oak	7,50
833 00 98 250	Wall skirting board for laminate, covered with decorative wood foil.	22 x 40 mm	250 cm	printing foil white	7,50

838 00 30 250	Wall skirting board for laminate, MDF-body with decoratve foil	22 x 40 mm	250 cm	white	7,15
838 00 31 250	Wall skirting board for laminate, MDF-body with decoratve foil	22 x 40 mm	250 cm	grey	7,15
838 00 32 250	Wall skirting board for laminate, MDF-body with decoratve foil	22 x 40 mm	250 cm	black	7,15

814 59 00 030	Clips for wall skirting boards, incl. screws and plugs.	30 pcs. / carton			9,40
---------------	---	------------------	--	--	------

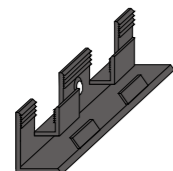

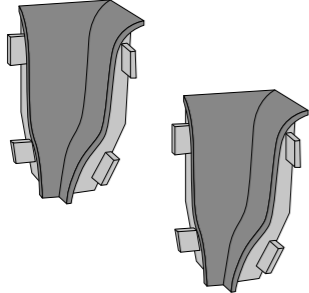
Schets	Artikelnummer	Omschrijving	Afmeting	Lengte	Kleur	Bruto verkoopprijs / st.
	814 17 76 002	Inner corners - PVC - for wall skirting board no.833.	22 x 40 mm	2 pcs. / bag	White Oak	3,70
	814 17 77 002	Inner corners - PVC - for wall skirting board no.833.	22 x 40 mm	2 pcs. / bag	Snow pine	3,70
	814 17 78 002	Inner corners - PVC - for wall skirting board no.833.	22 x 40 mm	2 pcs. / bag	Elegance Oak	3,70
	814 17 79 002	Inner corners - PVC - for wall skirting board no.833.	22 x 40 mm	2 pcs. / bag	Colorado Oak	3,70
	814 17 80 002	Inner corners - PVC - for wall skirting board no.833.	22 x 40 mm	2 pcs. / bag	Victoria Oak	3,70
	814 17 81 002	Inner corners - PVC - for wall skirting board no.833.	22 x 40 mm	2 pcs. / bag	Rushmore	3,70
	814 17 82 002	Inner corners - PVC - for wall skirting board no.833.	22 x 40 mm	2 pcs. / bag	Columbia Oak	3,70
	814 17 83 002	Inner corners - PVC - for wall skirting board no.833.	22 x 40 mm	2 pcs. / bag	Seattle Oak	3,70
	814 17 84 002	Inner corners - PVC - for wall skirting board no.833.	22 x 40 mm	2 pcs. / bag	maple	3,70
	814 17 86 002	Inner corners - PVC - for wall skirting board no.833.	22 x 40 mm	2 pcs. / bag	Aristan Oak	3,70
	814 17 87 002	Inner corners - PVC - for wall skirting board no.833.	22 x 40 mm	2 pcs. / bag	Evanos Oak	3,70
	814 17 88 002	Inner corners - PVC - for wall skirting board no.833.	22 x 40 mm	2 pcs. / bag	Royal Oak	3,70
	814 17 89 002	Inner corners - PVC - for wall skirting board no.833.	22 x 40 mm	2 pcs. / bag	Royal beech	3,70
	814 17 91 002	Inner corners - PVC - for wall skirting board no.833.	22 x 40 mm	2 pcs. / bag	beech	3,70
	814 17 92 002	Inner corners - PVC - for wall skirting board no.833.	22 x 40 mm	2 pcs. / bag	Aspen Oak	3,70
	814 17 93 002	Inner corners - PVC - for wall skirting board no.833.	22 x 40 mm	2 pcs. / bag	walnut	3,70
	814 17 94 002	Inner corners - PVC - for wall skirting board no.833.	22 x 40 mm	2 pcs. / bag	Canyon Pine	3,70
	814 17 96 002	Inner corners - PVC - for wall skirting board no.833.	22 x 40 mm	2 pcs. / bag	Attic Oak	3,70
	814 17 97 002	Inner corners - PVC - for wall skirting board no.833.	22 x 40 mm	2 pcs. / bag	Chateau Oak	3,70
	814 16 30 002	Inner corners - PVC - for wall skirting board no.838.	22 x 40 mm	2 pcs. / bag	white	3,70
814 16 31 002	Inner corners - PVC - for wall skirting board no.838.	22 x 40 mm	2 pcs. / bag	grey	3,70	
814 16 32 002	Inner corners - PVC - for wall skirting board no.838.	22 x 40 mm	2 pcs. / bag	black	3,70	

814 17 99 002	Inner corners - PVC - for wall skirting board no. 833/838.	22 x 40 mm	2 pcs. / bag	stainless steel	5,95
---------------	--	------------	--------------	-----------------	-------------

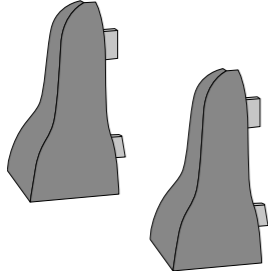
	814 27 76 002	Outer corners - PVC - for wall skirting board no.833.	22 x 40 mm	2 pcs. / bag	White Oak	3,70
	814 27 77 002	Outer corners - PVC - for wall skirting board no.833.	22 x 40 mm	2 pcs. / bag	Snow pine	3,70
	814 27 78 002	Outer corners - PVC - for wall skirting board no.833.	22 x 40 mm	2 pcs. / bag	Elegance Oak	3,70
	814 27 79 002	Outer corners - PVC - for wall skirting board no.833.	22 x 40 mm	2 pcs. / bag	Colorado Oak	3,70
	814 27 80 002	Outer corners - PVC - for wall skirting board no.833.	22 x 40 mm	2 pcs. / bag	Victoria Oak	3,70
	814 27 81 002	Outer corners - PVC - for wall skirting board no.833.	22 x 40 mm	2 pcs. / bag	Rushmore	3,70
	814 27 82 002	Outer corners - PVC - for wall skirting board no.833.	22 x 40 mm	2 pcs. / bag	Columbia Oak	3,70
	814 27 83 002	Outer corners - PVC - for wall skirting board no.833.	22 x 40 mm	2 pcs. / bag	Seattle Oak	3,70
	814 27 84 002	Outer corners - PVC - for wall skirting board no.833.	22 x 40 mm	2 pcs. / bag	maple	3,70
	814 27 86 002	Outer corners - PVC - for wall skirting board no.833.	22 x 40 mm	2 pcs. / bag	Aristan Oak	3,70
	814 27 87 002	Outer corners - PVC - for wall skirting board no.833.	22 x 40 mm	2 pcs. / bag	Evanos Oak	3,70
	814 27 88 002	Outer corners - PVC - for wall skirting board no.833.	22 x 40 mm	2 pcs. / bag	Royal Oak	3,70
	814 27 89 002	Outer corners - PVC - for wall skirting board no.833.	22 x 40 mm	2 pcs. / bag	Royal beech	3,70
	814 27 91 002	Outer corners - PVC - for wall skirting board no.833.	22 x 40 mm	2 pcs. / bag	beech	3,70
	814 27 92 002	Outer corners - PVC - for wall skirting board no.833.	22 x 40 mm	2 pcs. / bag	Aspen Oak	3,70
	814 27 93 002	Outer corners - PVC - for wall skirting board no.833.	22 x 40 mm	2 pcs. / bag	walnut	3,70
	814 27 94 002	Outer corners - PVC - for wall skirting board no.833.	22 x 40 mm	2 pcs. / bag	Canyon Pinie	3,70
	814 27 96 002	Outer corners - PVC - for wall skirting board no.833.	22 x 40 mm	2 pcs. / bag	Attic Oak	3,70
	814 27 97 002	Outer corners - PVC - for wall skirting board no.833.	22 x 40 mm	2 pcs. / bag	Chateau Oak	3,70
	814 26 30 002	Outer corners - PVC - for wall skirting board no.838.	22 x 40 mm	2 pcs. / bag	white	3,70
814 26 31 002	Outer corners - PVC - for wall skirting board no.838.	22 x 40 mm	2 pcs. / bag	grey	3,70	
814 26 32 002	Outer corners - PVC - for wall skirting board no.838.	22 x 40 mm	2 pcs. / bag	black	3,70	

814 27 99 002	Outer corners - PVC - for wall skirting board no. 833/838.	22 x 40 mm	2 pcs. / bag	stainless steel	5,95
---------------	--	------------	--------------	-----------------	-------------

Schets	Artikelnummer	Omschrijving	Afmeting	Lengte	Kleur	Bruto verkoopprijs / st.
	814 37 76 002	End caps - PVC - for wall skirting board no.833.	22 x 40 mm	1 lf + 1 ri / bag	White Oak	3,70
	814 37 77 002	End caps - PVC - for wall skirting board no.833.	22 x 40 mm	1 lf + 1 ri / bag	Snow pine	3,70
	814 37 78 002	End caps - PVC - for wall skirting board no.833.	22 x 40 mm	1 lf + 1 ri / bag	Elegance Oak	3,70
	814 37 79 002	End caps - PVC - for wall skirting board no.833.	22 x 40 mm	1 lf + 1 ri / bag	Colorado Oak	3,70
	814 37 80 002	End caps - PVC - for wall skirting board no.833.	22 x 40 mm	1 lf + 1 ri / bag	Victoria Oak	3,70
	814 37 81 002	End caps - PVC - for wall skirting board no.833.	22 x 40 mm	1 lf + 1 ri / bag	Rushmore	3,70
	814 37 82 002	End caps - PVC - for wall skirting board no.833.	22 x 40 mm	1 lf + 1 ri / bag	Columbia Oak	3,70
	814 37 83 002	End caps - PVC - for wall skirting board no.833.	22 x 40 mm	1 lf + 1 ri / bag	Seattle Oak	3,70
	814 37 84 002	End caps - PVC - for wall skirting board no.833.	22 x 40 mm	1 lf + 1 ri / bag	maple	3,70
	814 37 86 002	End caps - PVC - for wall skirting board no.833.	22 x 40 mm	1 lf + 1 ri / bag	Aristan Oak	3,70
	814 37 87 002	End caps - PVC - for wall skirting board no.833.	22 x 40 mm	1 lf + 1 ri / bag	Evanos Oak	3,70
	814 37 88 002	End caps - PVC - for wall skirting board no.833.	22 x 40 mm	1 lf + 1 ri / bag	Royal Oak	3,70
	814 37 89 002	End caps - PVC - for wall skirting board no.833.	22 x 40 mm	1 lf + 1 ri / bag	Royal beech	3,70
	814 37 91 002	End caps - PVC - for wall skirting board no.833.	22 x 40 mm	1 lf + 1 ri / bag	beech	3,70
	814 37 92 002	End caps - PVC - for wall skirting board no.833.	22 x 40 mm	1 lf + 1 ri / bag	Aspen Oak	3,70
	814 37 93 002	End caps - PVC - for wall skirting board no.833.	22 x 40 mm	1 lf + 1 ri / bag	walnut	3,70
	814 37 94 002	End caps - PVC - for wall skirting board no.833.	22 x 40 mm	1 lf + 1 ri / bag	Canyon Pinie	3,70
	814 37 96 002	End caps - PVC - for wall skirting board no.833.	22 x 40 mm	1 lf + 1 ri / bag	Attic Oak	3,70
	814 37 97 002	End caps - PVC - for wall skirting board no.833.	22 x 40 mm	1 lf + 1 ri / bag	Chateau Oak	3,70
	<hr/>					
	814 36 30 002	End caps - PVC - for wall skirting board no.838.	22 x 40 mm	1 lf + 1 ri / bag	white	3,70
	814 36 31 002	End caps - PVC - for wall skirting board no.838.	22 x 40 mm	1 lf + 1 ri / bag	grey	3,70
	814 36 32 002	End caps - PVC - for wall skirting board no.838.	22 x 40 mm	1 lf + 1 ri / bag	black	3,70
<hr/>						
	814 37 99 002	End caps - PVC - for wall skirting board no. 833/838.	22 x 40 mm	1 lf + 1 ri / bag	stainless steel	5,95

	817 00 30 250	Laminate skirting board, MDF core covered with decorative foil-Sockelleiste	10 x 58 mm	250 cm	white	8,65
--	---------------	---	------------	--------	-------	-------------

Quadrant for Laminate

	826 00 00 250	Quadrant for laminate	12 x 12 mm	250 cm	white printing foil	4,50
	826 00 30 250	Quadrant for laminate	12 x 12 mm	250 cm	white finish foil	4,50
	826 00 20 250	Quadrant for laminate	12 x 12 mm	250 cm	beech medium	4,50
	826 00 21 250	Quadrant for laminate	12 x 12 mm	250 cm	oak medium	4,50
	826 00 24 250	Quadrant for laminate	12 x 12 mm	250 cm	walnut red	4,50
	826 01 00 250	Quadrant for laminate	17 x 17 mm	250 cm	white printing foil	6,65

Schets	Artikelnummer	Omschrijving	Afmeting	Lengte	Kleur	Bruto verkoopprijs / st.
--------	---------------	--------------	----------	--------	-------	--------------------------

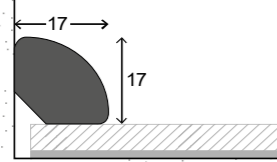

Wall skirting boards "Hamburg" and "Weimar"

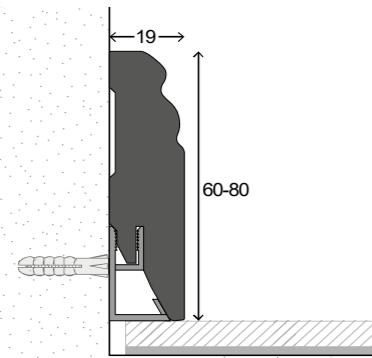

829 69 00 250	Skirting board "Hamburg" 19 mm - MDF body - incl. groove for clip fastening.	19 x 60 mm	250 cm	printing foil white	14,15
829 79 00 250	Skirting board "Hamburg" 19 mm - MDF body - incl. groove for clip fastening.	19 x 70 mm	250 cm	printing foil white	15,75
829 89 00 250	Skirting board "Hamburg" 19 mm - MDF body - incl. groove for clip fastening.	19 x 80 mm	250 cm	printing foil white	17,50

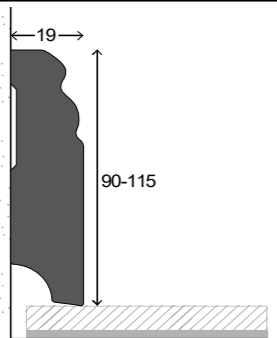

829 99 00 250	Skirting board "Hamburg" 19 mm - MDF body	19 x 90 mm	250 cm	printing foil white	18,75
829 10 00 250	Skirting board "Hamburg" 19 mm - MDF body	19 x 100 mm	250 cm	printing foil white	22,15
829 59 00 250	Skirting board "Hamburg" 19 mm - MDF body	19 x 115 mm	250 cm	printing foil white	24,40

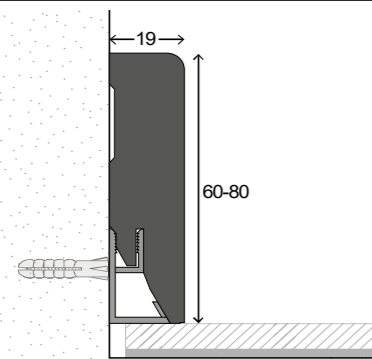

830 49 00 250	Skirting board "Weimar" 19 mm - MDF body - incl. groove for clip fastening.	19 x 40 mm	250 cm	white printing foil	11,90
830 69 00 250	Skirting board "Weimar" 19 mm - MDF body - incl. groove for clip fastening.	19 x 60 mm	250 cm	white printing foil	13,90
830 79 00 250	Skirting board "Weimar" 19 mm - MDF body - incl. groove for clip fastening.	19 x 70 mm	250 cm	white printing foil	15,50
830 89 00 250	Skirting board "Weimar" 19 mm - MDF body - incl. groove for clip fastening.	19 x 80 mm	250 cm	white printing foil	17,40

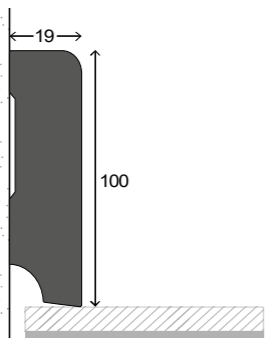

830 15 00 250	Skirting board "Weimar" 19 mm - MDF body	19 x 100 mm	250 cm	white printing foil	21,90
---------------	--	-------------	--------	---------------------	--------------



814 57 01 000	Corners for Hamburger and Weimarer skirting boards - 2 pcs. / bag.	22 x 22 mm	125 mm SB	white	9,25
---------------	--	------------	-----------	-------	-------------

Schets	Artikelnummer	Omschrijving	Afmeting	Lengte	Kleur	Bruto verkoopprijs / st.
--------	---------------	--------------	----------	--------	-------	--------------------------

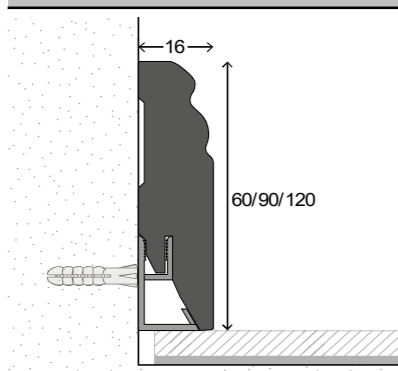
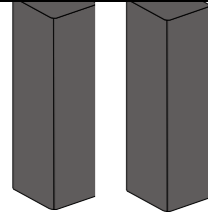

827 60 30 250	Skirting board "Hamburg" 16 mm - MDF body - incl. groove for clip fastening.	16 x 60 mm	250 cm	white finish foil	12,25
827 90 30 250	Skirting board "Hamburg" 16 mm - MDF body - incl. groove for clip fastening.	16 x 90 mm	250 cm	white finish foil	15,75
827 20 30 250	Skirting board "Hamburg" 16 mm - MDF body - incl. groove for clip fastening.	16 x 120 mm	250 cm	white finish foil	21,00

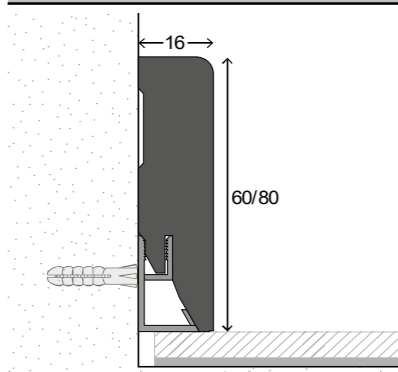

828 60 30 250	Skirting board "Weimar" 16 mm - MDF body - incl. groove for clip fastening.	16 x 60 mm	250 cm	white finish foil	12,00
828 80 30 250	Skirting board "Weimar" 16 mm - MDF body - incl. groove for clip fastening.	16 x 80 mm	250 cm	white finish foil	14,50

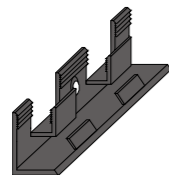

814 59 00 030	Clips for wall skirting boards, incl. screws and plugs.	30 pcs. / carton			9,40
---------------	---	------------------	--	--	-------------

PVC Skirting Boards

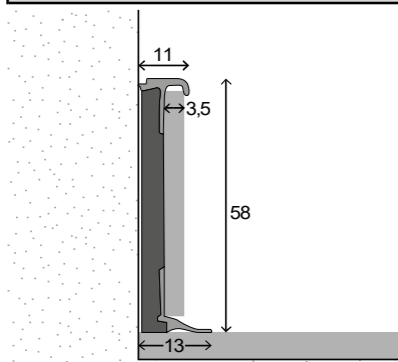

816 20 11 250	Slide-in wall skirting - PVC - for design floorings 2,0 - 3,5 mm.	58 mm	250 cm	silver	15,40
816 20 71 250	Slide-in wall skirting - PVC - for design floorings 2,0 - 3,5 mm.	58 mm	250 cm	champagne	15,40
816 20 45 250	Slide-in wall skirting - PVC - for design floorings 2,0 - 3,5 mm.	58 mm	250 cm	bronze	15,40
816 20 30 250	Slide-in wall skirting - PVC - for design floorings 2,0 - 3,5 mm.	58 mm	250 cm	white	15,40
816 20 41 250	Slide-in wall skirting - PVC - for design floorings 2,0 - 3,5 mm.	58 mm	250 cm	beige	15,40

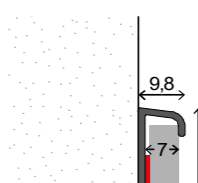

810 20 30 250	Carpet skirting without bridge - PVC	51 mm	250 cm	white	7,15
810 20 44 250	Carpet skirting without bridge - PVC	51 mm	250 cm	dark grey	7,15
810 20 45 250	Carpet skirting without bridge - PVC	51 mm	250 cm	silvergrey	7,15
810 20 20 250	Carpet skirting without bridge - PVC	51 mm	250 cm	beech	7,15
810 20 49 250	Carpet skirting without bridge - PVC	51 mm	250 cm	light oak	7,15

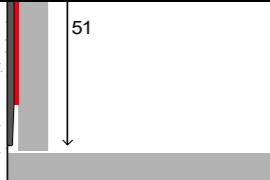
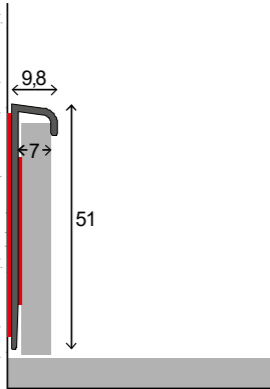
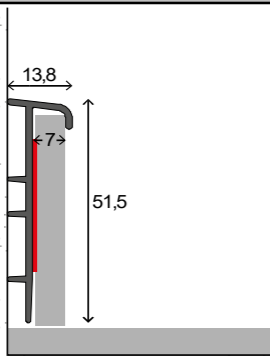
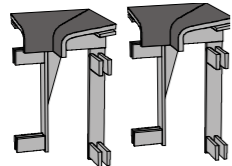
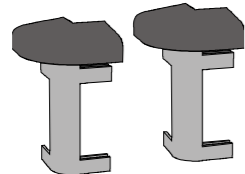
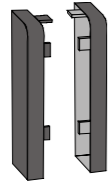
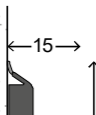
Schets	Artikelnummer	Omschrijving	Afmeting	Lengte	Kleur	Bruto verkoopprijs / st.
	810 20 32 250	Carpet skirting without bridge - PVC	51 mm	250 cm	black	7,15
	810 30 30 250	Carpet skirting without bridge - PVC - self-adhesive.	51 mm	250 cm	white	8,90
	810 30 32 250	Carpet skirting without bridge - PVC - self-adhesive.	51 mm	250 cm	black	8,90
	810 30 45 250	Carpet skirting without bridge - PVC - self-adhesive.	51 mm	250 cm	silvergrey	8,90
	810 30 20 250	Carpet skirting without bridge - PVC - self-adhesive.	51 mm	250 cm	beech	8,90
	810 30 49 250	Carpet skirting without bridge - PVC - self-adhesive.	51 mm	250 cm	light oak	8,90
	810 30 24 250	Carpet skirting without bridge - PVC - self-adhesive.	51 mm	250 cm	walnut	8,90
	810 10 30 250	Carpet skirting with bridge - PVC	51,5 mm	250 cm	white	7,15
	810 10 32 250	Carpet skirting with bridge - PVC	51,5 mm	250 cm	black	7,15
	810 10 44 250	Carpet skirting with bridge - PVC	51,5 mm	250 cm	dark grey	7,15
	810 10 45 250	Carpet skirting with bridge - PVC	51,5 mm	250 cm	silvergrey	7,15
	810 10 20 250	Carpet skirting with bridge - PVC	51,5 mm	250 cm	beech	7,15
	810 10 49 250	Carpet skirting with bridge - PVC	51,5 mm	250 cm	light oak	7,15
	814 11 30 002	Inner corners - PVC - for carpet skirting with bridge.	2 pcs. per bag		white	4,40
	814 11 32 002	Inner corners - PVC - for carpet skirting with bridge.	2 pcs. per bag		black	4,40
	814 11 44 002	Inner corners - PVC - for carpet skirting with bridge.	2 pcs. per bag		dark grey	4,40
	814 11 45 002	Inner corners - PVC - for carpet skirting with bridge.	2 pcs. per bag		silvergrey	4,40
	814 11 20 002	Inner corners - PVC - for carpet skirting with bridge.	2 pcs. per bag		beech	4,40
	814 11 49 002	Inner corners - PVC - for carpet skirting with bridge.	2 pcs. per bag		light oak	4,40
	814 21 30 002	Outer corners - PVC - for carpet skirting with bridge.	2 pcs. per bag		white	4,40
	814 21 32 002	Outer corners - PVC - for carpet skirting with bridge.	2 pcs. per bag		black	4,40
	814 21 44 002	Outer corners - PVC - for carpet skirting with bridge.	2 pcs. per bag		dark grey	4,40
	814 21 45 002	Outer corners - PVC - for carpet skirting with bridge.	2 pcs. per bag		silvergrey	4,40
	814 21 20 002	Outer corners - PVC - for carpet skirting with bridge.	2 pcs. per bag		beech	4,40
	814 21 49 002	Outer corners - PVC - for carpet skirting with bridge.	2 pcs. per bag		light oak	4,40
	814 31 30 002	End caps - PVC - for carpet skirting with bridge.	1 left+1 right/bag		white	4,40
	814 31 32 002	End caps - PVC - for carpet skirting with bridge.	1 left+1 right/bag		black	4,40
	814 31 44 002	End caps - PVC - for carpet skirting with bridge.	1 left+1 right/bag		dark grey	4,40
	814 31 45 002	End caps - PVC - for carpet skirting with bridge.	1 left+1 right/bag		silvergrey	4,40
	814 31 20 002	End caps - PVC - for carpet skirting with bridge.	1 left+1 right/bag		beech	4,40
	814 31 49 002	End caps - PVC - for carpet skirting with bridge.	1 left+1 right/bag		light oak	4,40
	811 20 30 255	Hard-core skirting board - PVC.	60 mm	250 cm	white	7,75
	811 20 31 255	Hard-core skirting board - PVC.	60 mm	250 cm	light grey	7,75
	811 20 44 255	Hard-core skirting board - PVC.	60 mm	250 cm	dark grey	7,75
	811 20 32 255	Hard-core skirting board - PVC.	60 mm	250 cm	black	7,75

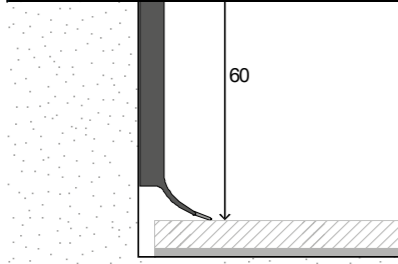
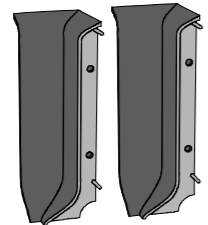
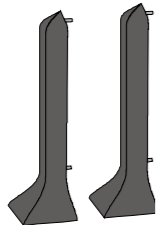
Schets	Artikelnummer	Omschrijving	Afmeting	Lengte	Kleur	Bruto verkoopprijs / st.
	811 20 11 255	Hard-core skirting board - PVC.	60 mm	250 cm	silver	7,75
	811 20 01 255	Hard-core skirting board - PVC.	60 mm	250 cm	acacia vintage	7,75
	811 20 13 255	Hard-core skirting board - PVC.	60 mm	250 cm	grey oak	7,75
	811 20 14 255	Hard-core skirting board - PVC.	60 mm	250 cm	Barbate oak	7,75
	811 20 17 255	Hard-core skirting board - PVC.	60 mm	250 cm	Cloudy beige	7,75
	811 20 18 255	Hard-core skirting board - PVC.	60 mm	250 cm	Oak natural	7,75
	811 20 19 255	Hard-core skirting board - PVC.	60 mm	250 cm	Oak rusty	7,75
	811 20 20 255	Hard-core skirting board - PVC.	60 mm	250 cm	beech	7,75
	811 20 22 255	Hard-core skirting board - PVC.	60 mm	250 cm	maple	7,75
	811 20 24 255	Hard-core skirting board - PVC.	60 mm	250 cm	walnut	7,75
	811 20 40 255	Hard-core skirting board - PVC.	60 mm	250 cm	Oak graceland	7,75
	811 20 41 255	Hard-core skirting board - PVC.	60 mm	250 cm	Oak light	7,75
	811 20 49 255	Hard-core skirting board - PVC.	60 mm	250 cm	light oak	7,75
	811 20 52 255	Hard-core skirting board - PVC.	60 mm	250 cm	white ash	7,75
	814 12 30 002	Inner corner - PVC - for hard-core skirting boards 60 mm.	2 pcs/bag		white	3,25
	814 12 31 002	Inner corner - PVC - for hard-core skirting boards 60 mm.	2 pcs/bag		light grey	3,25
	814 12 44 002	Inner corner - PVC - for hard-core skirting boards 60 mm.	2 pcs/bag		dark grey	3,25
	814 12 32 002	Inner corner - PVC - for hard-core skirting boards 60 mm.	2 pcs/bag		black	3,25
	814 12 11 002	Inner corner - PVC - for hard-core skirting boards 60 mm.	2 pcs/bag		silver	3,25
	814 12 01 002	Inner corner - PVC - for hard-core skirting boards 60 mm.	2 pcs/bag		acacia vintage	3,25
	814 12 13 002	Inner corner - PVC - for hard-core skirting boards 60 mm.	2 pcs/bag		grey oak	3,25
	814 12 14 002	Inner corner - PVC - for hard-core skirting boards 60 mm.	2 pcs/bag		Barbate oak	3,25
	814 12 17 002	Inner corner - PVC - for hard-core skirting boards 60 mm.	2 pcs/bag		Cloudy beige	3,25
	814 12 18 002	Inner corner - PVC - for hard-core skirting boards 60 mm.	2 pcs/bag		Oak natural	3,25
	814 12 19 002	Inner corner - PVC - for hard-core skirting boards 60 mm.	2 pcs/bag		Oak rusty	3,25
	814 12 20 002	Inner corner - PVC - for hard-core skirting boards 60 mm.	2 pcs/bag		beech	3,25
	814 12 22 002	Inner corner - PVC - for hard-core skirting boards 60 mm.	2 pcs/bag		maple	3,25
	814 12 24 002	Inner corner - PVC - for hard-core skirting boards 60 mm.	2 pcs/bag		walnut	3,25
814 12 40 002	Inner corner - PVC - for hard-core skirting boards 60 mm.	2 pcs/bag		Oak Graceland	3,25	
814 12 41 002	Inner corner - PVC - for hard-core skirting boards 60 mm.	2 pcs/bag		Oak Hollywood	3,25	
814 12 49 002	Inner corner - PVC - for hard-core skirting boards 60 mm.	2 pcs/bag		light oak	3,25	
	814 22 30 002	Outer corner - PVC - for hard-core skirting boards 60 mm.	2 pcs/bag		white	3,25
	814 22 31 002	Outer corner - PVC - for hard-core skirting boards 60 mm.	2 pcs/bag		light grey	3,25
	814 22 44 002	Outer corner - PVC - for hard-core skirting boards 60 mm.	2 pcs/bag		dark grey	3,25
	814 22 32 002	Outer corner - PVC - for hard-core skirting boards 60 mm.	2 pcs/bag		black	3,25
	814 22 11 002	Outer corner - PVC - for hard-core skirting boards 60 mm.	2 pcs/bag		silver	3,25
	814 22 01 002	Outer corner - PVC - for hard-core skirting boards 60 mm.	2 pcs/bag		acacia vintage	3,25
	814 22 13 002	Outer corner - PVC - for hard-core skirting boards 60 mm.	2 pcs/bag		grey oak	3,25
	814 22 14 002	Outer corner - PVC - for hard-core skirting boards 60 mm.	2 pcs/bag		Barbate oak	3,25
	814 22 17 002	Outer corner - PVC - for hard-core skirting boards 60 mm.	2 pcs/bag		Cloudy beige	3,25
	814 22 18 002	Outer corner - PVC - for hard-core skirting boards 60 mm.	2 pcs/bag		Oak natural	3,25
	814 22 19 002	Outer corner - PVC - for hard-core skirting boards 60 mm.	2 pcs/bag		Oak rusty	3,25
	814 22 20 002	Outer corner - PVC - for hard-core skirting boards 60 mm.	2 pcs/bag		beech	3,25
	814 22 22 002	Outer corner - PVC - for hard-core skirting boards 60 mm.	2 pcs/bag		maple	3,25
	814 22 24 002	Outer corner - PVC - for hard-core skirting boards 60 mm.	2 pcs/bag		walnut	3,25
814 22 40 002	Outer corner - PVC - for hard-core skirting boards 60 mm.	2 pcs/bag		Oak Graceland	3,25	

Schets	Artikelnummer	Omschrijving	Afmeting	Lengte	Kleur	Bruto verkoopprijs / st.
	814 22 41 002	Outer corner - PVC - for hard-core skirting boards 60 mm.	2 pcs/bag		Oak Hollywood	3,25
	814 22 49 002	Outer corner - PVC - for hard-core skirting boards 60 mm.	2 pcs/bag		light oak	3,25

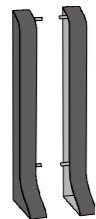

	814 32 30 002	End caps - PVC - for hard-core skirting boards 60 mm.	1 left+1 right/bag		white	3,25
	814 32 31 002	End caps - PVC - for hard-core skirting boards 60 mm.	1 left+1 right/bag		light grey	3,25
	814 32 44 002	End caps - PVC - for hard-core skirting boards 60 mm.	1 left+1 right/bag		dark grey	3,25
	814 32 32 002	End caps - PVC - for hard-core skirting boards 60 mm.	1 left+1 right/bag		black	3,25
	814 32 11 002	End caps - PVC - for hard-core skirting boards 60 mm.	1 left+1 right/bag		silver	3,25

	814 32 01 002	End caps - PVC - for hard-core skirting boards 60 mm.	1 left+1 right/bag		acacia vintage	3,25
	814 32 13 002	End caps - PVC - for hard-core skirting boards 60 mm.	1 left+1 right/bag		grey oak	3,25
	814 32 14 002	End caps - PVC - for hard-core skirting boards 60 mm.	1 left+1 right/bag		Barbate oak	3,25
	814 32 17 002	End caps - PVC - for hard-core skirting boards 60 mm.	1 left+1 right/bag		Cloudy beige	3,25
	814 32 18 002	End caps - PVC - for hard-core skirting boards 60 mm.	1 left+1 right/bag		Oak natural	3,25
	814 32 19 002	End caps - PVC - for hard-core skirting boards 60 mm.	1 left+1 right/bag		Oak rusty	3,25
	814 32 20 002	End caps - PVC - for hard-core skirting boards 60 mm.	1 left+1 right/bag		beech	3,25
	814 32 22 002	End caps - PVC - for hard-core skirting boards 60 mm.	1 left+1 right/bag		maple	3,25
	814 32 24 002	End caps - PVC - for hard-core skirting boards 60 mm.	1 left+1 right/bag		walnut	3,25
	814 32 40 002	End caps - PVC - for hard-core skirting boards 60 mm.	1 left+1 right/bag		Oak Graceland	3,25
	814 32 41 002	End caps - PVC - for hard-core skirting boards 60 mm.	1 left+1 right/bag		Oak Hollywood	3,25
	814 32 49 002	End caps - PVC - for hard-core skirting boards 60 mm.	1 left+1 right/bag		light oak	3,25

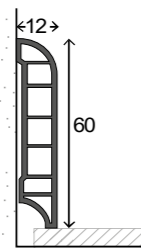

	813 10 30 240	Hollow chamber skirting board „Cellpro 60“ - foamed plastic - floor covering width 12 mm	60 x 12 mm	240 cm	white	11,40
	813 10 32 240	Hollow chamber skirting board „Cellpro 60“ - foamed plastic - floor covering width 12 mm	60 x 12 mm	240 cm	black	11,40

	813 10 25 240	Hollow chamber skirting board „Cellpro 60“ - foamed plastic - floor covering width 12 mm	60 x 12 mm	240 cm	Oak light	11,80
	813 10 26 240	Hollow chamber skirting board „Cellpro 60“ - foamed plastic - floor covering width 12 mm	60 x 12 mm	240 cm	Honey oak	11,80
	813 10 27 240	Hollow chamber skirting board „Cellpro 60“ - foamed plastic - floor covering width 12 mm	60 x 12 mm	240 cm	Desert oak	11,80
	813 10 28 240	Hollow chamber skirting board „Cellpro 60“ - foamed plastic - floor covering width 12 mm	60 x 12 mm	240 cm	Oak grey	11,80
	813 10 29 240	Hollow chamber skirting board „Cellpro 60“ - foamed plastic - floor covering width 12 mm	60 x 12 mm	240 cm	Oak rusty	11,80

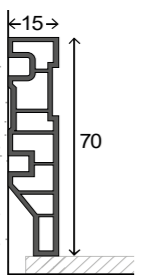

	817 10 30 240	Hollow chamber skirting board „Cellpro70“ - foamed plastic - floor covering width 15 mm	70 x 15 mm	240 cm	white	13,95
	817 10 32 240	Hollow chamber skirting board „Cellpro70“ - foamed plastic - floor covering width 15 mm	70 x 15 mm	240 cm	black	13,95

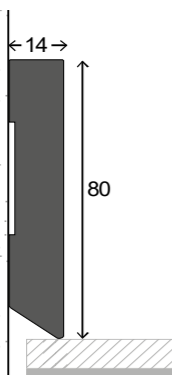

	844 02 30 240	Foamed skirting board „Mondo 80“ - PVC - floor covering width 14 mm.	80 x 14 mm	240 cm	white	17,90
--	---------------	--	------------	--------	-------	--------------

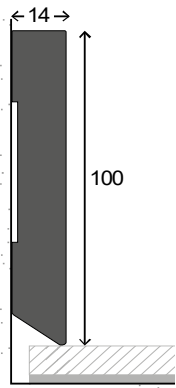
Schets	Artikelnummer	Omschrijving	Afmeting	Lengte	Kleur	Bruto verkoopprijs / st.
	844 03 30 240	Foamed skirting board „Mondo 100“ - PVC - floor covering width 14 mm.	100 x 14 mm	240 cm	white	21,25

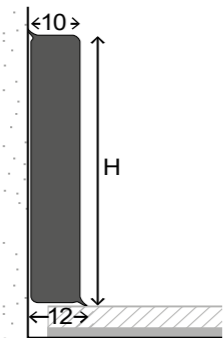
	843 01 30 250	"Tondo 40" hard foam skirting incl. sealing lips - punchable	40 x 12 mm	250 cm	white	12,25
	843 01 31 250	"Tondo 40" hard foam skirting incl. sealing lips - punchable	40 x 12 mm	250 cm	grey	12,25
	843 02 30 250	Hard foam skirting board "Tondo 60", incl. sealing lips.	60 x 12 mm	250 cm	white	13,50
	843 02 31 250	Hard foam skirting board "Tondo 60", incl. sealing lips.	60 x 12 mm	250 cm	grey	13,50
	843 02 32 250	Hard foam skirting board "Tondo 60", incl. sealing lips.	60 x 12 mm	250 cm	black	15,50
	843 03 30 250	Hard foam skirting board "Tondo 80", incl. sealing lips.	80 x 12 mm	250 cm	white	26,40
843 03 32 250	Hard foam skirting board "Tondo 80", incl. sealing lips.	80 x 12 mm	250 cm	black	26,40	

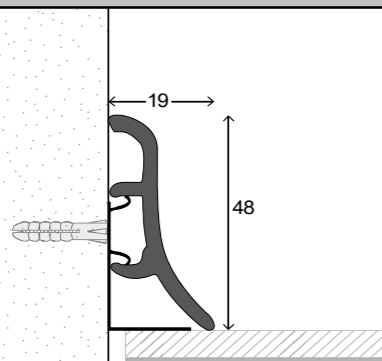
	812 10 30 250	Skirting board - foamed plastic.	48 x 19 mm	250 cm	white	6,25
	812 10 45 250	Skirting board - foamed plastic.	48 x 19 mm	250 cm	silvergrey	6,25
	812 10 77 250	Skirting board - foamed plastic.	48 x 19 mm	250 cm	graphit	6,25
	812 10 20 250	Skirting board - foamed plastic.	48 x 19 mm	250 cm	beech	6,25
	812 10 22 250	Skirting board - foamed plastic.	48 x 19 mm	250 cm	maple	6,25
	812 10 52 250	Skirting board - foamed plastic.	48 x 19 mm	250 cm	white ash	6,25
	812 10 01 250	Skirting board - foamed plastic.	48 x 19 mm	250 cm	acacia vintage	6,25
	812 10 04 250	Skirting board - foamed plastic.	48 x 19 mm	250 cm	rustic oak	6,25

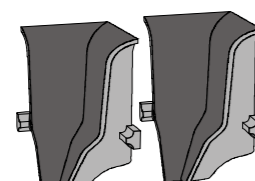

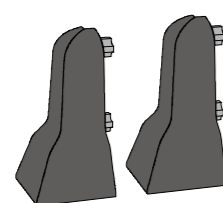
	814 13 30 002	PVC Inner corner - for skirting board, foamed, 48 mm.	2 pcs/bag		white	3,50
	814 13 45 002	PVC Inner corner - for skirting board, foamed, 48 mm.	2 pcs/bag		silvergrey	3,50
	814 13 77 002	PVC Inner corner - for skirting board, foamed, 48 mm.	2 pcs/bag		graphit	3,50
	814 13 20 002	PVC Inner corner - for skirting board, foamed, 48 mm.	2 pcs/bag		beech	3,50
	814 13 22 002	PVC Inner corner - for skirting board, foamed, 48 mm.	2 pcs/bag		maple	3,50
	814 13 01 002	PVC Inner corner - for skirting board, foamed, 48 mm.	2 pcs/bag		acacia vintage	3,50
	814 13 04 002	PVC Inner corner - for skirting board, foamed, 48 mm.	2 pcs/bag		rustic oak	3,50

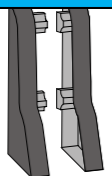
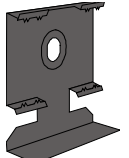
	814 23 30 002	PVC Outer corner - for skirting board, foamed, 48 mm.	2 pcs/bag		white	3,50
	814 23 45 002	PVC Outer corner - for skirting board, foamed, 48 mm.	2 pcs/bag		silvergrey	3,50
	814 23 77 002	PVC Outer corner - for skirting board, foamed, 48 mm.	2 pcs/bag		graphit	3,50
	814 23 20 002	PVC Outer corner - for skirting board, foamed, 48 mm.	2 pcs/bag		beech	3,50
	814 23 22 002	PVC Outer corner - for skirting board, foamed, 48 mm.	2 pcs/bag		maple	3,50
	814 23 01 002	PVC Outer corner - for skirting board, foamed, 48 mm.	2 pcs/bag		acacia vintage	3,50
	814 23 04 002	PVC Outer corner - for skirting board, foamed, 48 mm.	2 pcs/bag		rustic oak	3,50
814 33 30 002	PVC End Cap - for skirting board, foamed, 48 mm.	1 left+1 right/bag		white	3,50	

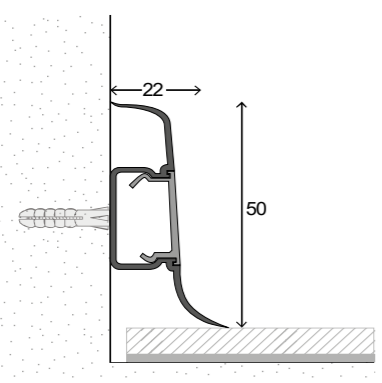
Schets	Artikelnummer	Omschrijving	Afmeting	Lengte	Kleur	Bruto verkoopprijs / st.
	814 33 45 002	PVC End Cap - for skirting board, foamed, 48 mm.	1 left+1 right/bag		silvergrey	3,50
	814 33 77 002	PVC End Cap - for skirting board, foamed, 48 mm.	1 left+1 right/bag		graphit	3,50
	814 33 20 002	PVC End Cap - for skirting board, foamed, 48 mm.	1 left+1 right/bag		beech	3,50
	814 33 22 002	PVC End Cap - for skirting board, foamed, 48 mm.	1 left+1 right/bag		maple	3,50
	814 33 01 002	PVC End Cap - for skirting board, foamed, 48 mm.	1 left+1 right/bag		acacia vintage	3,50
	814 33 04 002	PVC End Cap - for skirting board, foamed, 48 mm.	1 left+1 right/bag		rustic oak	3,50
	814 51 00 020	Fixing clips - metal, galvanised - for skirting board, foamed, 48 mm.	20 pcs/bag			6,25

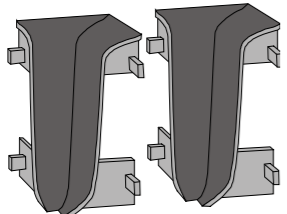
	818 10 30 250	Skirting board with cable duct - PCV, flexible.	50 x 22 mm	250 cm	white	7,75
	818 10 44 250	Skirting board with cable duct - PCV, flexible.	50 x 22 mm	250 cm	dark grey	7,75
	818 10 01 250	Skirting board with cable duct - PCV, flexible.	50 x 22 mm	250 cm	acacia vintage	7,75
	818 10 02 250	Skirting board with cable duct - PCV, flexible.	50 x 22 mm	250 cm	dark beech	7,75
	818 10 03 250	Skirting board with cable duct - PCV, flexible.	50 x 22 mm	250 cm	Montana oak	7,75
	818 10 04 250	Skirting board with cable duct - PCV, flexible.	50 x 22 mm	250 cm	rustic oak	7,75
	818 10 05 250	Skirting board with cable duct - PCV, flexible.	50 x 22 mm	250 cm	Canadian spruce	7,75
	818 10 06 250	Skirting board with cable duct - PCV, flexible.	50 x 22 mm	250 cm	walnut red	7,75
	818 10 07 250	Skirting board with cable duct - PCV, flexible.	50 x 22 mm	250 cm	walnut oliv	7,75
	818 10 08 250	Skirting board with cable duct - PCV, flexible.	50 x 22 mm	250 cm	Panga-Panga	7,75
	818 10 10 250	Skirting board with cable duct - PCV, flexible.	50 x 22 mm	250 cm	Woodstock white	7,75
	818 10 11 250	Skirting board with cable duct - PCV, flexible.	50 x 22 mm	250 cm	stonegrey	7,75
	818 10 12 250	Skirting board with cable duct - PCV, flexible.	50 x 22 mm	250 cm	slate	7,75
	818 10 13 250	Skirting board with cable duct - PCV, flexible.	50 x 22 mm	250 cm	grey oak	7,75
	818 10 14 250	Skirting board with cable duct - PCV, flexible.	50 x 22 mm	250 cm	Barbate oak	7,75
	818 10 15 250	Skirting board with cable duct - PCV, flexible.	50 x 22 mm	250 cm	hornbeam	7,75
	818 10 16 250	Skirting board with cable duct - PCV, flexible.	50 x 22 mm	250 cm	Cloudy grey	7,75
	818 10 17 250	Skirting board with cable duct - PCV, flexible.	50 x 22 mm	250 cm	Cloudy beige	7,75
	818 10 18 250	Skirting board with cable duct - PCV, flexible.	50 x 22 mm	250 cm	Oak natural	7,75
	818 10 19 250	Skirting board with cable duct - PCV, flexible.	50 x 22 mm	250 cm	Oak rusty	7,75
	818 10 20 250	Skirting board with cable duct - PCV, flexible.	50 x 22 mm	250 cm	beech	7,75
	818 10 22 250	Skirting board with cable duct - PCV, flexible.	50 x 22 mm	250 cm	maple	7,75
	818 10 24 250	Skirting board with cable duct - PCV, flexible.	50 x 22 mm	250 cm	walnut	7,75
	818 10 29 250	Skirting board with cable duct - PCV, flexible.	50 x 22 mm	250 cm	Wenge	7,75
	818 10 40 250	Skirting board with cable duct - PCV, flexible.	50 x 22 mm	250 cm	Oak Graceland	7,75
	818 10 41 250	Skirting board with cable duct - PCV, flexible.	50 x 22 mm	250 cm	Oak Hollywood	7,75
	818 10 42 250	Skirting board with cable duct - PCV, flexible.	50 x 22 mm	250 cm	Oak Calgary	7,75
	818 10 49 250	Skirting board with cable duct - PCV, flexible.	50 x 22 mm	250 cm	light oak	7,75

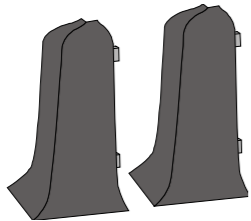
	814 15 01 002	Inner Corners - PVC - for clip skirting boards 50 mm.	2 pcs/bag		acacia vintage	4,05
	814 15 02 002	Inner Corners - PVC - for clip skirting boards 50 mm.	2 pcs/bag		dark beech	4,05
	814 15 03 002	Inner Corners - PVC - for clip skirting boards 50 mm.	2 pcs/bag		Montana oak	4,05
	814 15 04 002	Inner Corners - PVC - for clip skirting boards 50 mm.	2 pcs/bag		rustic oak	4,05
	814 15 05 002	Inner Corners - PVC - for clip skirting boards 50 mm.	2 pcs/bag		Canadian spruce	4,05
	814 15 06 002	Inner Corners - PVC - for clip skirting boards 50 mm.	2 pcs/bag		walnut red	4,05
	814 15 07 002	Inner Corners - PVC - for clip skirting boards 50 mm.	2 pcs/bag		walnut oliv	4,05
	814 15 08 002	Inner Corners - PVC - for clip skirting boards 50 mm.	2 pcs/bag		Panga-Panga	4,05
	814 15 10 002	Inner Corners - PVC - for clip skirting boards 50 mm.	2 pcs/bag		Woodstock white	4,05
	814 15 11 002	Inner Corners - PVC - for clip skirting boards 50 mm.	2 pcs/bag		stonegrey	4,05

Schets	Artikelnummer	Omschrijving	Afmeting	Lengte	Kleur	Bruto verkoopprijs / st.
	814 15 12 002	Inner Corners - PVC - for clip skirting boards 50 mm.	2 pcs/bag		slate	4,05
	814 15 13 002	Inner Corners - PVC - for clip skirting boards 50 mm.	2 pcs/bag		grey oak	4,05
	814 15 14 002	Inner Corners - PVC - for clip skirting boards 50 mm.	2 pcs/bag		Barbate oak	4,05
	814 15 15 002	Inner Corners - PVC - for clip skirting boards 50 mm.	2 pcs/bag		hornbeam	4,05
	814 15 16 002	Inner Corners - PVC - for clip skirting boards 50 mm.	2 pcs/bag		Cloudy grey	4,05
	814 15 17 002	Inner Corners - PVC - for clip skirting boards 50 mm.	2 pcs/bag		Cloudy beige	4,05
	814 15 18 002	Inner Corners - PVC - for clip skirting boards 50 mm.	2 pcs/bag		Oak natural	4,05
	814 15 19 002	Inner Corners - PVC - for clip skirting boards 50 mm.	2 pcs/bag		Oak rusty	4,05
	814 15 20 002	Inner Corners - PVC - for clip skirting boards 50 mm.	2 pcs/bag		beech	4,05
	814 15 22 002	Inner Corners - PVC - for clip skirting boards 50 mm.	2 pcs/bag		maple	4,05
	814 15 24 002	Inner Corners - PVC - for clip skirting boards 50 mm.	2 pcs/bag		walnut	4,05
	814 15 29 002	Inner Corners - PVC - for clip skirting boards 50 mm.	2 pcs/bag		Wenge	4,05
	814 15 30 002	Inner Corners - PVC - for clip skirting boards 50 mm.	2 pcs/bag		white	4,05
	814 15 40 002	Inner Corners - PVC - for clip skirting boards 50 mm.	2 pcs/bag		Oak Graceland	4,05
	814 15 41 002	Inner Corners - PVC - for clip skirting boards 50 mm.	2 pcs/bag		Oak Hollywood	4,05
	814 15 42 002	Inner Corners - PVC - for clip skirting boards 50 mm.	2 pcs/bag		Oak Calgary	4,05
	814 15 44 002	Inner Corners - PVC - for clip skirting boards 50 mm.	2 pcs/bag		dark grey	4,05
	814 15 49 002	Inner Corners - PVC - for clip skirting boards 50 mm.	2 pcs/bag		light oak	4,05
	814 25 01 002	Outer Corners - PVC - for clip skirting boards 50 mm.	2 pcs/bag		acacia vintage	4,05
	814 25 02 002	Outer Corners - PVC - for clip skirting boards 50 mm.	2 pcs/bag		dark beech	4,05
	814 25 03 002	Outer Corners - PVC - for clip skirting boards 50 mm.	2 pcs/bag		Montana oak	4,05
	814 25 04 002	Outer Corners - PVC - for clip skirting boards 50 mm.	2 pcs/bag		rustic oak	4,05
	814 25 05 002	Outer Corners - PVC - for clip skirting boards 50 mm.	2 pcs/bag		Canadian spruce	4,05
	814 25 06 002	Outer Corners - PVC - for clip skirting boards 50 mm.	2 pcs/bag		walnut red	4,05
	814 25 07 002	Outer Corners - PVC - for clip skirting boards 50 mm.	2 pcs/bag		walnut oliv	4,05
	814 25 08 002	Outer Corners - PVC - for clip skirting boards 50 mm.	2 pcs/bag		Panga-Panga	4,05
	814 25 10 002	Outer Corners - PVC - for clip skirting boards 50 mm.	2 pcs/bag		Woodstock white	4,05
	814 25 11 002	Outer Corners - PVC - for clip skirting boards 50 mm.	2 pcs/bag		stonegrey	4,05
	814 25 12 002	Outer Corners - PVC - for clip skirting boards 50 mm.	2 pcs/bag		slate	4,05
	814 25 13 002	Outer Corners - PVC - for clip skirting boards 50 mm.	2 pcs/bag		grey oak	4,05
	814 25 14 002	Outer Corners - PVC - for clip skirting boards 50 mm.	2 pcs/bag		Barbate oak	4,05
	814 25 15 002	Outer Corners - PVC - for clip skirting boards 50 mm.	2 pcs/bag		hornbeam	4,05
	814 25 16 002	Outer Corners - PVC - for clip skirting boards 50 mm.	2 pcs/bag		Cloudy grey	4,05
	814 25 17 002	Outer Corners - PVC - for clip skirting boards 50 mm.	2 pcs/bag		Cloudy beige	4,05
	814 25 18 002	Outer Corners - PVC - for clip skirting boards 50 mm.	2 pcs/bag		Oak natural	4,05
	814 25 19 002	Outer Corners - PVC - for clip skirting boards 50 mm.	2 pcs/bag		Oak rusty	4,05
	814 25 20 002	Outer Corners - PVC - for clip skirting boards 50 mm.	2 pcs/bag		beech	4,05
	814 25 22 002	Outer Corners - PVC - for clip skirting boards 50 mm.	2 pcs/bag		maple	4,05
	814 25 24 002	Outer Corners - PVC - for clip skirting boards 50 mm.	2 pcs/bag		walnut	4,05
	814 25 29 002	Outer Corners - PVC - for clip skirting boards 50 mm.	2 pcs/bag		Wenge	4,05
	814 25 30 002	Outer Corners - PVC - for clip skirting boards 50 mm.	2 pcs/bag		white	4,05
	814 25 40 002	Outer Corners - PVC - for clip skirting boards 50 mm.	2 pcs/bag		Oak Graceland	4,05
	814 25 41 002	Outer Corners - PVC - for clip skirting boards 50 mm.	2 pcs/bag		Oak Hollywood	4,05
	814 25 42 002	Outer Corners - PVC - for clip skirting boards 50 mm.	2 pcs/bag		Oak Calgary	4,05
	814 25 44 002	Outer Corners - PVC - for clip skirting boards 50 mm.	2 pcs/bag		dark grey	4,05
	814 25 49 002	Outer Corners - PVC - for clip skirting boards 50 mm.	2 pcs/bag		light oak	4,05
	814 35 01 002	End caps - PVC - for clip skirting boards 50 mm.	1 left+1 right/bag		acacia vintage	4,05
	814 35 02 002	End caps - PVC - for clip skirting boards 50 mm.	1 left+1 right/bag		dark beech	4,05
	814 35 03 002	End caps - PVC - for clip skirting boards 50 mm.	1 left+1 right/bag		Montana oak	4,05

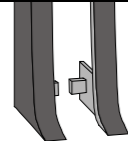
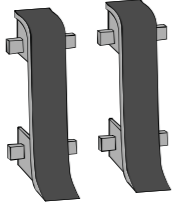
Schets	Artikelnummer	Omschrijving	Afmeting	Lengte	Kleur	Bruto verkoopprijs / st.
	814 35 04 002	End caps - PVC - for clip skirting boards 50 mm.	1 left+1 right/bag		rustic oak	4,05
	814 35 05 002	End caps - PVC - for clip skirting boards 50 mm.	1 left+1 right/bag		Canadian spruce	4,05
	814 35 06 002	End caps - PVC - for clip skirting boards 50 mm.	1 left+1 right/bag		walnut red	4,05
	814 35 07 002	End caps - PVC - for clip skirting boards 50 mm.	1 left+1 right/bag		walnut oliv	4,05
	814 35 08 002	End caps - PVC - for clip skirting boards 50 mm.	1 left+1 right/bag		Panga-Panga	4,05
	814 35 10 002	End caps - PVC - for clip skirting boards 50 mm.	1 left+1 right/bag		Woodstock white	4,05
	814 35 11 002	End caps - PVC - for clip skirting boards 50 mm.	1 left+1 right/bag		stonegrey	4,05
	814 35 12 002	End caps - PVC - for clip skirting boards 50 mm.	1 left+1 right/bag		slate	4,05
	814 35 13 002	End caps - PVC - for clip skirting boards 50 mm.	1 left+1 right/bag		grey oak	4,05
	814 35 14 002	End caps - PVC - for clip skirting boards 50 mm.	1 left+1 right/bag		Barbate oak	4,05
	814 35 15 002	End caps - PVC - for clip skirting boards 50 mm.	1 left+1 right/bag		hornbeam	4,05
	814 35 16 002	End caps - PVC - for clip skirting boards 50 mm.	1 left+1 right/bag		Cloudy grey	4,05
	814 35 17 002	End caps - PVC - for clip skirting boards 50 mm.	1 left+1 right/bag		Cloudy beige	4,05
	814 35 18 002	End caps - PVC - for clip skirting boards 50 mm.	1 left+1 right/bag		Oak natural	4,05
	814 35 19 002	End caps - PVC - for clip skirting boards 50 mm.	1 left+1 right/bag		Oak rusty	4,05
	814 35 20 002	End caps - PVC - for clip skirting boards 50 mm.	1 left+1 right/bag		beech	4,05
	814 35 22 002	End caps - PVC - for clip skirting boards 50 mm.	1 left+1 right/bag		maple	4,05
	814 35 24 002	End caps - PVC - for clip skirting boards 50 mm.	1 left+1 right/bag		walnut	4,05
	814 35 29 002	End caps - PVC - for clip skirting boards 50 mm.	1 left+1 right/bag		Wenge	4,05
	814 35 30 002	End caps - PVC - for clip skirting boards 50 mm.	1 left+1 right/bag		white	4,05
814 35 40 002	End caps - PVC - for clip skirting boards 50 mm.	1 left+1 right/bag		Oak Graceland	4,05	
814 35 41 002	End caps - PVC - for clip skirting boards 50 mm.	1 left+1 right/bag		Oak Hollywood	4,05	
814 35 42 002	End caps - PVC - for clip skirting boards 50 mm.	1 left+1 right/bag		Oak Calgary	4,05	
814 35 44 002	End caps - PVC - for clip skirting boards 50 mm.	1 left+1 right/bag		dark grey	4,05	
814 35 49 002	End caps - PVC - for clip skirting boards 50 mm.	1 left+1 right/bag		light oak	4,05	
	814 45 01 002	Profile ties - PVC - for clip skirting boards 50 mm.	2 pcs/bag		acacia vintage	4,05
	814 45 02 002	Profile ties - PVC - for clip skirting boards 50 mm.	2 pcs/bag		dark beech	4,05
	814 45 03 002	Profile ties - PVC - for clip skirting boards 50 mm.	2 pcs/bag		Montana oak	4,05
	814 45 04 002	Profile ties - PVC - for clip skirting boards 50 mm.	2 pcs/bag		rustic oak	4,05
	814 45 05 002	Profile ties - PVC - for clip skirting boards 50 mm.	2 pcs/bag		Canadian spruce	4,05
	814 45 06 002	Profile ties - PVC - for clip skirting boards 50 mm.	2 pcs/bag		walnut red	4,05
	814 45 07 002	Profile ties - PVC - for clip skirting boards 50 mm.	2 pcs/bag		walnut oliv	4,05
	814 45 08 002	Profile ties - PVC - for clip skirting boards 50 mm.	2 pcs/bag		Panga-Panga	4,05
	814 45 10 002	Profile ties - PVC - for clip skirting boards 50 mm.	2 pcs/bag		Woodstock white	4,05
	814 45 11 002	Profile ties - PVC - for clip skirting boards 50 mm.	2 pcs/bag		stonegrey	4,05
	814 45 12 002	Profile ties - PVC - for clip skirting boards 50 mm.	2 pcs/bag		slate	4,05
	814 45 13 002	Profile ties - PVC - for clip skirting boards 50 mm.	2 pcs/bag		grey oak	4,05
	814 45 14 002	Profile ties - PVC - for clip skirting boards 50 mm.	2 pcs/bag		Barbate oak	4,05
	814 45 15 002	Profile ties - PVC - for clip skirting boards 50 mm.	2 pcs/bag		hornbeam	4,05
	814 45 16 002	Profile ties - PVC - for clip skirting boards 50 mm.	2 pcs/bag		Cloudy grey	4,05
	814 45 17 002	Profile ties - PVC - for clip skirting boards 50 mm.	2 pcs/bag		Cloudy beige	4,05
	814 45 18 002	Profile ties - PVC - for clip skirting boards 50 mm.	2 pcs/bag		Oak natural	4,05
	814 45 19 002	Profile ties - PVC - for clip skirting boards 50 mm.	2 pcs/bag		Oak rusty	4,05
	814 45 20 002	Profile ties - PVC - for clip skirting boards 50 mm.	2 pcs/bag		beech	4,05
	814 45 22 002	Profile ties - PVC - for clip skirting boards 50 mm.	2 pcs/bag		maple	4,05
814 45 24 002	Profile ties - PVC - for clip skirting boards 50 mm.	2 pcs/bag		walnut	4,05	
814 45 29 002	Profile ties - PVC - for clip skirting boards 50 mm.	2 pcs/bag		Wenge	4,05	
814 45 30 002	Profile ties - PVC - for clip skirting boards 50 mm.	2 pcs/bag		white	4,05	
814 45 40 002	Profile ties - PVC - for clip skirting boards 50 mm.	2 pcs/bag		Oak Graceland	4,05	
814 45 41 002	Profile ties - PVC - for clip skirting boards 50 mm.	2 pcs/bag		Oak Hollywood	4,05	

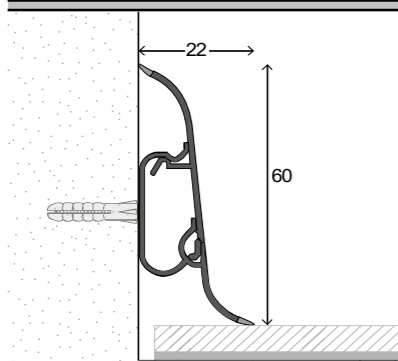
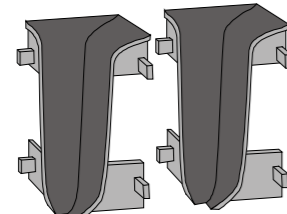
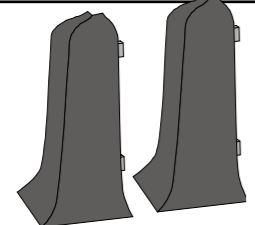
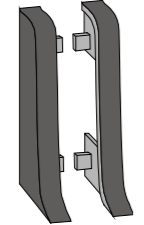
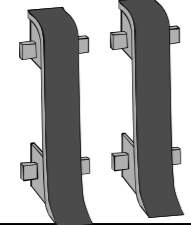
Schets	Artikelnummer	Omschrijving	Afmeting	Lengte	Kleur	Bruto verkoopprijs / st.
	814 45 42 002	Profile ties - PVC - for clip skirting boards 50 mm.	2 pcs/bag		Oak Calgary	4,05
	814 45 44 002	Profile ties - PVC - for clip skirting boards 50 mm.	2 pcs/bag		dark grey	4,05
	814 45 49 002	Profile ties - PVC - for clip skirting boards 50 mm.	2 pcs/bag		light oak	4,05
	837 00 30 250	Wall skirting board with cable channel - two parts - PVC.	60 x 22 mm	250 cm	white	8,25
	837 00 44 250	Wall skirting board with cable channel - two parts - PVC.	60 x 22 mm	250 cm	dark grey	8,25
	837 00 20 250	Wall skirting board with cable channel - two parts - PVC.	60 x 22 mm	250 cm	beech	8,25
	837 00 01 250	Wall skirting board with cable channel - two parts - PVC.	60 x 22 mm	250 cm	acacia vintage	8,25
	837 00 04 250	Wall skirting board with cable channel - two parts - PVC.	60 x 22 mm	250 cm	rustic oak	8,25
	837 00 10 250	Wall skirting board with cable channel - two parts - PVC.	60 x 22 mm	250 cm	Woodstock white	8,25
	814 19 30 002	Inner corners - PVC - for wall skirting board with cable channel 60 mm.	2 pcs/bag		white	4,50
	814 19 44 002	Inner corners - PVC - for wall skirting board with cable channel 60 mm.	2 pcs/bag		dark grey	4,50
	814 19 20 002	Inner corners - PVC - for wall skirting board with cable channel 60 mm.	2 pcs/bag		beech	4,50
	814 19 01 002	Inner corners - PVC - for wall skirting board with cable channel 60 mm.	2 pcs/bag		acacia vintage	4,50
	814 19 04 002	Inner corners - PVC - for wall skirting board with cable channel 60 mm.	2 pcs/bag		rustic oak	4,50
	814 19 10 002	Inner corners - PVC - for wall skirting board with cable channel 60 mm.	2 pcs/bag		Woodstock white	4,50
	814 29 30 002	Outer corners - PVC - for wall skirting board with cable channel 60 mm.	2 pcs/bag		white	4,50
	814 29 44 002	Outer corners - PVC - for wall skirting board with cable channel 60 mm.	2 pcs/bag		dark grey	4,50
	814 29 20 002	Outer corners - PVC - for wall skirting board with cable channel 60 mm.	2 pcs/bag		beech	4,50
	814 29 01 002	Outer corners - PVC - for wall skirting board with cable channel 60 mm.	2 pcs/bag		acacia vintage	4,50
	814 29 04 002	Outer corners - PVC - for wall skirting board with cable channel 60 mm.	2 pcs/bag		rustic oak	4,50
	814 29 10 002	Outer corners - PVC - for wall skirting board with cable channel 60 mm.	2 pcs/bag		Woodstock white	4,50
	814 39 30 002	End caps - PVC - for wall skirting board with cable channel 60 mm.	1 left+1 right/bag		white	4,50
	814 39 44 002	End caps - PVC - for wall skirting board with cable channel 60 mm.	1 left+1 right/bag		dark grey	4,50
	814 39 20 002	End caps - PVC - for wall skirting board with cable channel 60 mm.	1 left+1 right/bag		beech	4,50
	814 39 01 002	End caps - PVC - for wall skirting board with cable channel 60 mm.	1 left+1 right/bag		acacia vintage	4,50
	814 39 04 002	End caps - PVC - for wall skirting board with cable channel 60 mm.	1 left+1 right/bag		rustic oak	4,50
	814 39 10 002	End caps - PVC - for wall skirting board with cable channel 60 mm.	1 left+1 right/bag		Woodstock white	4,50
	814 49 30 002	Profile ties - PVC - for wall skirting board with cable channel 60 mm.	2 pcs/bag		white	4,50
	814 49 44 002	Profile ties - PVC - for wall skirting board with cable channel 60 mm.	2 pcs/bag		dark grey	4,50
	814 49 20 002	Profile ties - PVC - for wall skirting board with cable channel 60 mm.	2 pcs/bag		beech	4,50
	814 49 01 002	Profile ties - PVC - for wall skirting board with cable channel 60 mm.	2 pcs/bag		acacia vintage	4,50
	814 49 04 002	Profile ties - PVC - for wall skirting board with cable channel 60 mm.	2 pcs/bag		rustic oak	4,50
	814 49 10 002	Profile ties - PVC - for wall skirting board with cable channel 60 mm.	2 pcs/bag		Woodstock white	4,50

Price List 2025 - Accessories

Accessories for Parquet and Laminate

















850 21 00 000	Spacers - hard wood.	12 pcs / bag		hard wood	4,40
---------------	----------------------	--------------	--	-----------	------



850 22 00 000	Spacers - PVC.	20 pcs/ bag		PVC	7,25
---------------	----------------	-------------	--	-----	------



Schets	Artikelnummer	Omschrijving	Afmeting	Lengte	Kleur	Bruto verkoopprijs / st.
						
	850 12 00 000	Accessories for laying parquet: tension iron, tapping block and 20 spacers of PVC.				16,20
	850 30 00 000	Tapping block	30 x 5 x 3 cm		hard wood	6,90
	850 32 00 000	Tapping block "professional" with handle.	60 cm	60 cm		29,60
	850 41 00 000	Tension iron - sturdy metal, painted.	30 x 5 cm			8,55
	850 42 00 000	Tension iron "professional" - heavy, solid design.	45 cm			20,70
	850 45 00 000	Tension iron "professional" with a 110 mm wide edge - heavy, solid design.	45 cm			31,90
	850 53 00 000	Spatula - width 180 mm, serration A1	180 mm			3,60
	850 54 00 000	Spatula - width 180 mm, serration A2	180 mm			3,60
	850 51 00 000	Spatula - width 180 mm, serration B2	180 mm			3,60
	850 52 00 000	Spatula - width 180 mm, serration B3	180 mm			3,60
Back Saw and Mitrebox						
	835 00 00 000	Back saw with mitrebox - for skirting boards with a height up to 100 mm.				26,85
Felt Pads						

Schets	Artikelnummer	Omschrijving	Afmeting	Lengte	Kleur	Bruto verkoopprijs / st.
	852 22 30 000	Felt pads - self-adhesive, paper strap with 12 pieces	22 mm Ø		white	1,45
	852 22 40 000	Felt pads - self-adhesive, paper strap with 12 pieces	22 mm Ø		brown	1,45
	852 23 30 000	Felt pads - self-adhesive, paper strap with 9 pieces	28 mm Ø		white	1,45
	852 23 40 000	Felt pads - self-adhesive, paper strap with 9 pieces	28 mm Ø		brown	1,45
	852 24 30 000	Felt pads - self-adhesive, paper strap with 4 pieces	35 mm Ø		white	1,45
	852 24 40 000	Felt pads - self-adhesive, paper strap with 4 pieces	35 mm Ø		brown	1,45
	852 25 30 000	Felt pads - self-adhesive, paper strap with 12 pieces	22 x 22 mm		white	1,45
	852 25 40 000	Felt pads - self-adhesive, paper strap with 12 pieces	22 x 22 mm		brown	1,45
	852 26 30 000	Felt pads - self-adhesive, paper strap with 1 pieces	100 x 100 mm		white	1,45

Radiator Cover Plates



852 13 30 000	Radiator cover plates - LD polyethylene, self fastening.	Inner-Ø 15 mm		white	1,40
852 14 30 000	Radiator cover plates - LD polyethylene, self fastening.	Inner-Ø 18 mm		white	1,40
852 15 30 000	Radiator cover plates - LD polyethylene, self fastening.	Inner-Ø 22 mm		white	1,40
852 13 31 000	Radiator cover plates - LD polyethylene, self fastening.	Inner-Ø 15 mm		grey	1,40
852 14 31 000	Radiator cover plates - LD polyethylene, self fastening.	Inner-Ø 18 mm		grey	1,40
852 15 31 000	Radiator cover plates - LD polyethylene, self fastening.	Inner-Ø 22 mm		grey	1,40
852 13 32 000	Radiator cover plates - LD polyethylene, self fastening.	Inner-Ø 15 mm		black	1,40
852 14 32 000	Radiator cover plates - LD polyethylene, self fastening.	Inner-Ø 18 mm		black	1,40
852 15 32 000	Radiator cover plates - LD polyethylene, self fastening.	Inner-Ø 22 mm		black	1,40

852 13 20 000	Radiator cover plates - LD polyethylene, self fastening.	Inner-Ø 15 mm		beech/oak	1,40
852 11 20 000	Radiator cover plates - LD polyethylene, self fastening.	Inner-Ø 18 mm		beech/oak	1,40
852 12 20 000	Radiator cover plates - LD polyethylene, self fastening.	Inner-Ø 22 mm		beech/oak	1,40
852 13 22 000	Radiator cover plates - LD polyethylene, self fastening.	Inner-Ø 15 mm		maple/ash	1,40
852 11 22 000	Radiator cover plates - LD polyethylene, self fastening.	Inner-Ø 18 mm		maple/ash	1,40
852 12 22 000	Radiator cover plates - LD polyethylene, self fastening.	Inner-Ø 22 mm		maple/ash	1,40
852 13 24 000	Radiator cover plates - LD polyethylene, self fastening.	Inner-Ø 15 mm		walnut	1,40
852 11 24 000	Radiator cover plates - LD polyethylene, self fastening.	Inner-Ø 18 mm		walnut	1,40
852 12 24 000	Radiator cover plates - LD polyethylene, self fastening.	Inner-Ø 22 mm		walnut	1,40

Adhesive Tapes



820 20 50 005	Adhesive tape - woven fabric backing - adhesive on both sides.	50 mm	5 m SB		2,45
820 20 50 010	Adhesive tape - woven fabric backing - adhesive on both sides.	50 mm	10 m SB		4,60
820 20 50 025	Adhesive tape - woven fabric backing - adhesive on both sides.	50 mm	25 m SB		10,15



820 30 50 005	Adhesive tape "special"- woven fabric backing - adhesive on both sides.	50 mm	5 m SB		2,50
820 30 50 010	Adhesive tape "special"- woven fabric backing - adhesive on both sides.	50 mm	10 m SB		4,85
820 30 50 025	Adhesive tape "special"- woven fabric backing - adhesive on both sides.	50 mm	25 m SB		11,00

Contact Adhesives



822 00 35 025	Contact adhesive "special".	35 mm	25 m		31,25
822 00 35 050	Contact adhesive "special".	35 mm	50 m		62,50

Knives and Blades

Schets	Artikelnummer	Omschrijving	Afmeting	Lengte	Kleur	Bruto verkoopprijs / st.
	835 14 00 000	Knife "Auto load & Auto lock" - on skin card. Magazine with 6 blades	18 mm			10,30
	835 13 00 000	Automatic-knife, reinforced with steel guide - on skin card.	18 mm			2,30
	836 12 00 000	Snap-off blades (10 blades in plastic box on skin card).	18 mm			1,95
	835 21 00 000	Utility knife - on blister card.				4,70
	835 24 00 000	Utility knife with retractable blade - on skin card.				5,35
	835 32 06 000	Heavy duty knife with retractable blade - on skin card.				11,20
	835 16 00 000	Utility knife with quick release fastener - on skin card. incl. 3 trapeze blades				11,90
	835 33 06 000	Heavy duty knife - with quick release fastener - on skin card. incl. 5 trapeze blades				11,20
	836 21 00 000	Straight blade STANDARD 5 blades in dispenser on SB card	0,5 mm			1,25
	836 22 00 000	Hooked blade STANDARD 5 blades in dispenser on SB card	0,5 mm			2,50
	836 31 00 000	Blade PROF1 10 blades in dispenser on SB card	0,65 mm			2,65
	836 32 00 000	Hooked blade PROF1 10 blades in dispenser on SB card	0,65 mm			5,15
	836 33 00 000	Super-hooked blade PROF1 10 dispensers of 10 blades / loose	0,65 mm			6,15

Schets	Artikelnummer	Omschrijving	Afmeting	Lengte	Kleur	Bruto verkoopprijs / st.
--------	---------------	--------------	----------	--------	-------	--------------------------

Fastening Items



831 11 60 025	Nails for wall skirting boards - bag with 100 pieces	1,5 mm	25 mm SB	steel, galvanised	2,40
831 11 60 035	Nails for wall skirting boards - bag with 100 pieces	1,5 mm	35 mm SB	steel, galvanised	3,00
831 12 60 025	Nails for wall skirting boards - 1000 pcs. in a box (price per 100 pcs.)	1,5 mm	25 mm	steel, galvanised	2,45
831 12 60 035	Nails for wall skirting boards - 1000 pcs. in a box (price per 100 pcs.)	1,5 mm	35 mm	steel, galvanised	2,90
831 12 60 045	Nails for wall skirting boards - 1000 pcs. in a box (price per 100 pcs.)	1,5 mm	45 mm	steel, galvanised	3,85



831 21 61 025	Nails for wall skirting boards - bag with 100 pieces	1,5 mm	25 mm SB	steel, dyed blue	2,40
831 21 61 035	Nails for wall skirting boards - bag with 100 pieces	1,5 mm	35 mm SB	steel, dyed blue	2,75



832 20 62 025	Philips Wood screws (price per 100 pcs.)	3,0 x 25 mm	25 mm	silver	4,55
832 20 63 025	Philips Wood screws (price per 100 pcs.)	3,0 x 25 mm	25 mm	gold	4,55
832 20 65 025	Philips Wood screws (price per 100 pcs.)	3,0 x 25 mm	25 mm	sahara	4,55
832 20 66 025	Philips Wood screws (price per 100 pcs.)	3,0 x 25 mm	25 mm	stainless steel matt	5,50
832 20 64 025	Philips Wood screws (price per 100 pcs.)	3,0 x 25 mm	25 mm	bronze	5,50



832 30 00 025	PVC plugs (Price per 100 pieces)	5,0 x 25 mm	25 mm		3,90
---------------	----------------------------------	-------------	-------	--	-------------



832 42 62 025	Bag with 15 screws and plugs	3,0 mm	25 mm SB	silver	2,00
832 42 63 025	Bag with 15 screws and plugs	3,0 mm	25 mm SB	gold	2,00
832 42 64 025	Bag with 15 screws and plugs	3,0 mm	25 mm SB	bronze	2,00
832 42 65 025	Bag with 15 screws and plugs	3,0 mm	25 mm SB	sahara	2,00
832 42 66 025	Bag with 15 screws and plugs	3,0 mm	25 mm SB	stainless steel matt	2,00